

3688

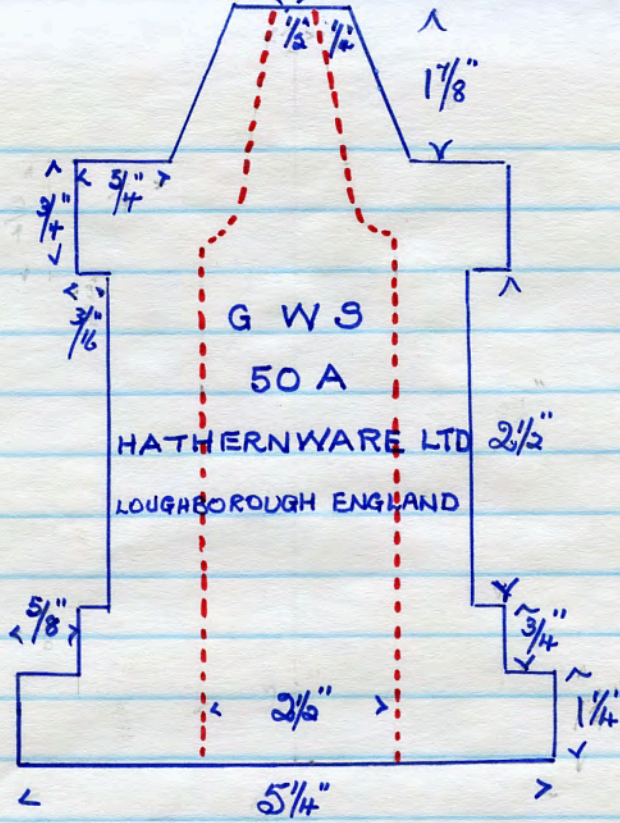

G W S 50 A HATHERNWARE LTD

LOUGHBOROUGH ENGLAND

incised.

pattern for a pinnacle

5 1/2 lbs.

A.G.M. of B.B. Soc. held at Hathern Station Bk. Wks 18. 6. '88

SECTION THROUGH

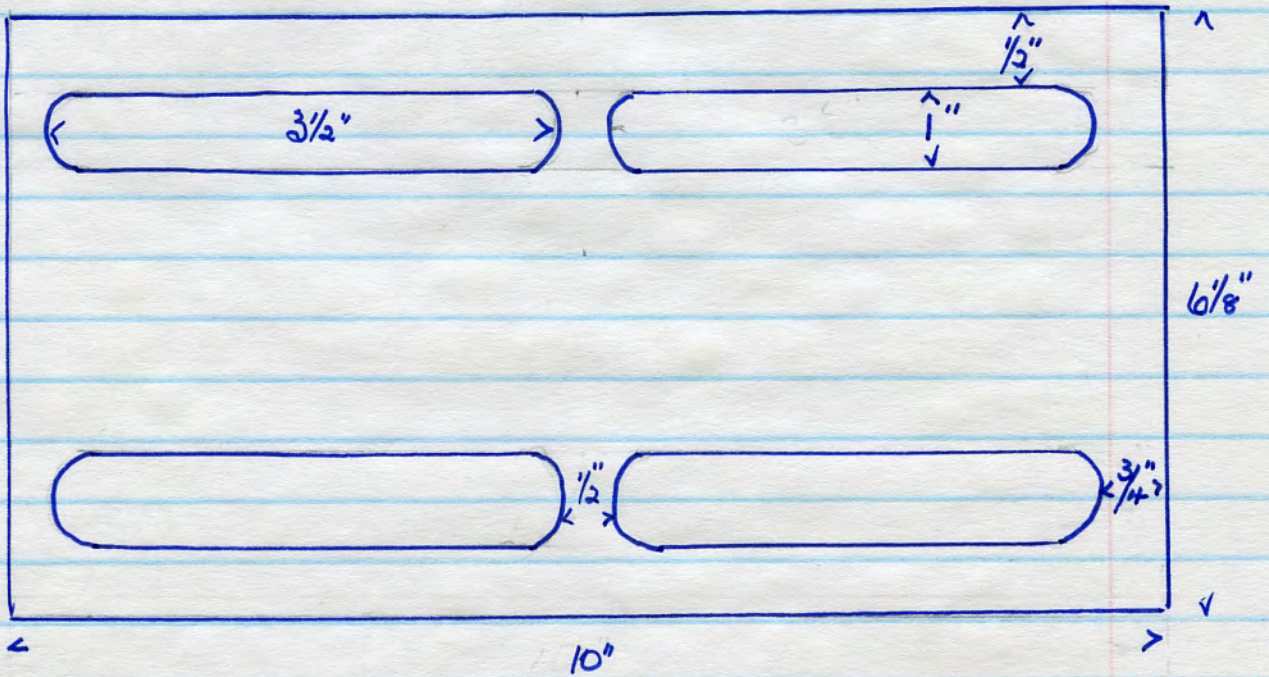

3690

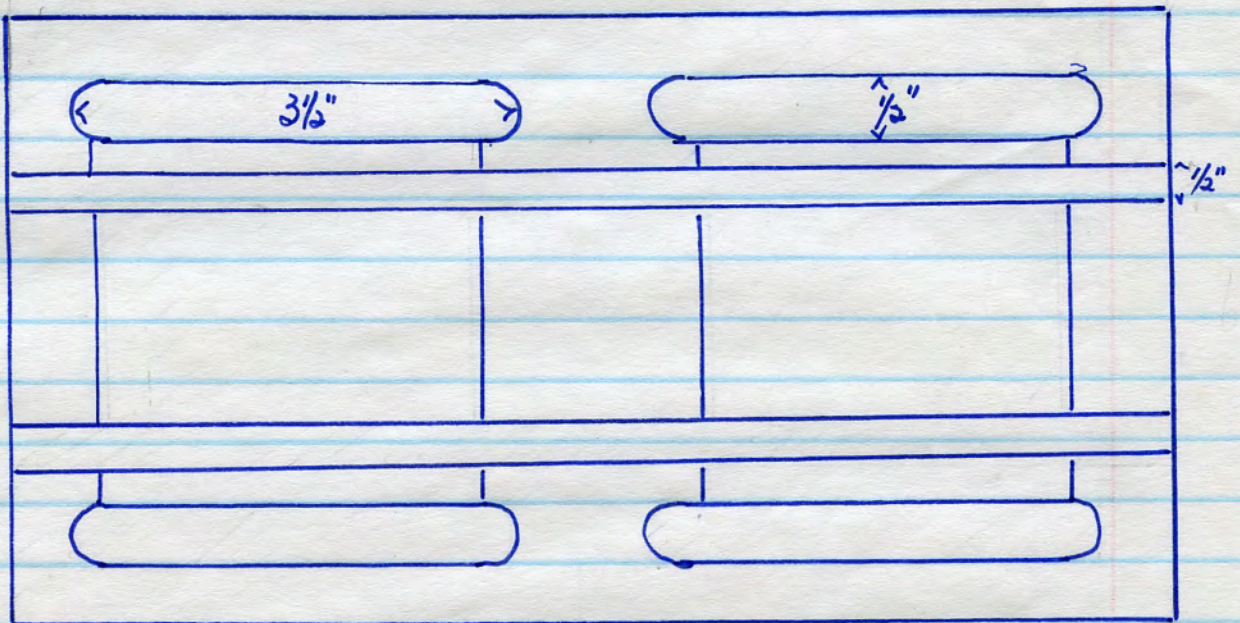

No name. dark brown

14 lbs.

dem. of Brunley Abbotts 7. 7. '88.

3691

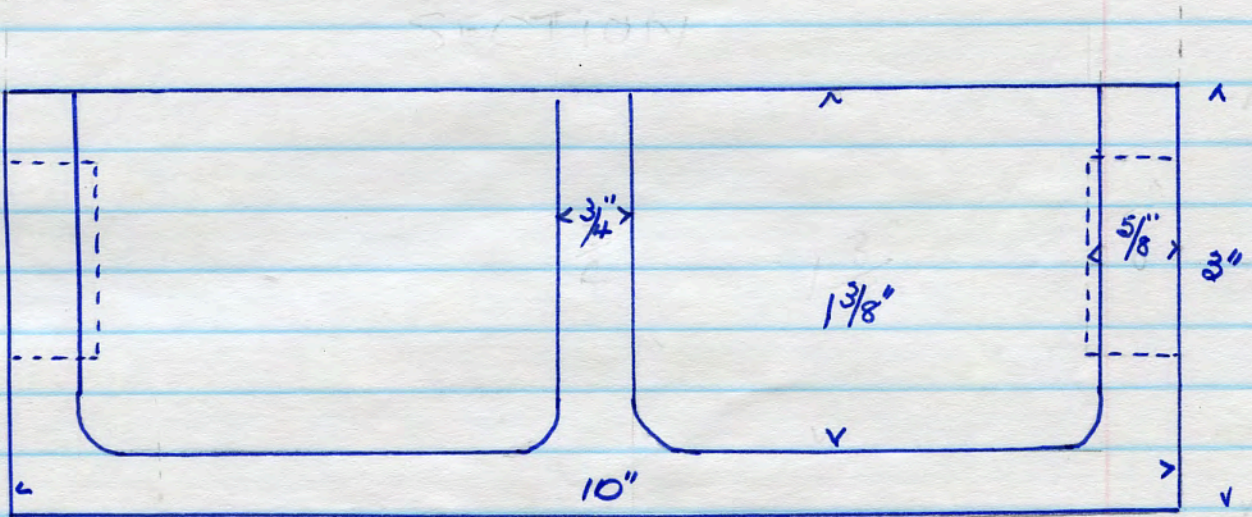
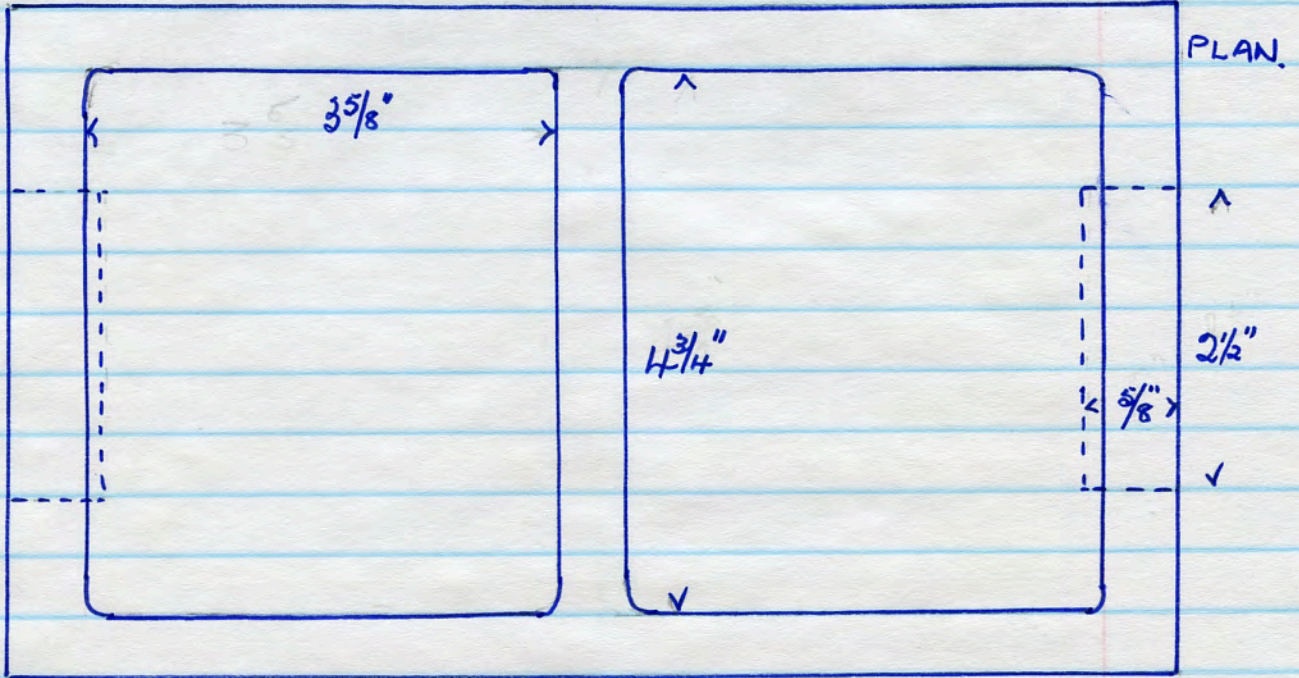

no name. dark brown

14 lbs.

dem. of Burnley Abbatoin 7. 7. '88

No name.

M 30 6022 M buff terra cotta
38 lbs. letters scratched

3707

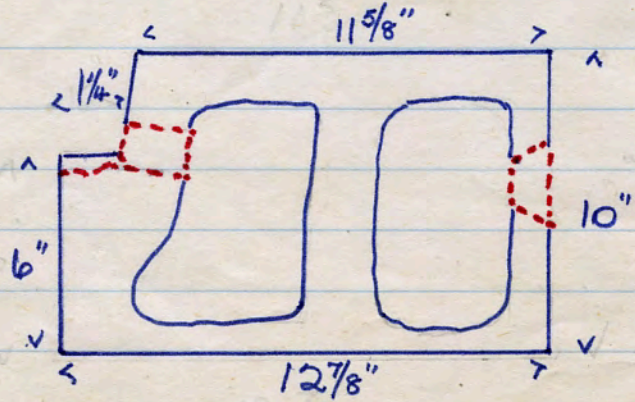
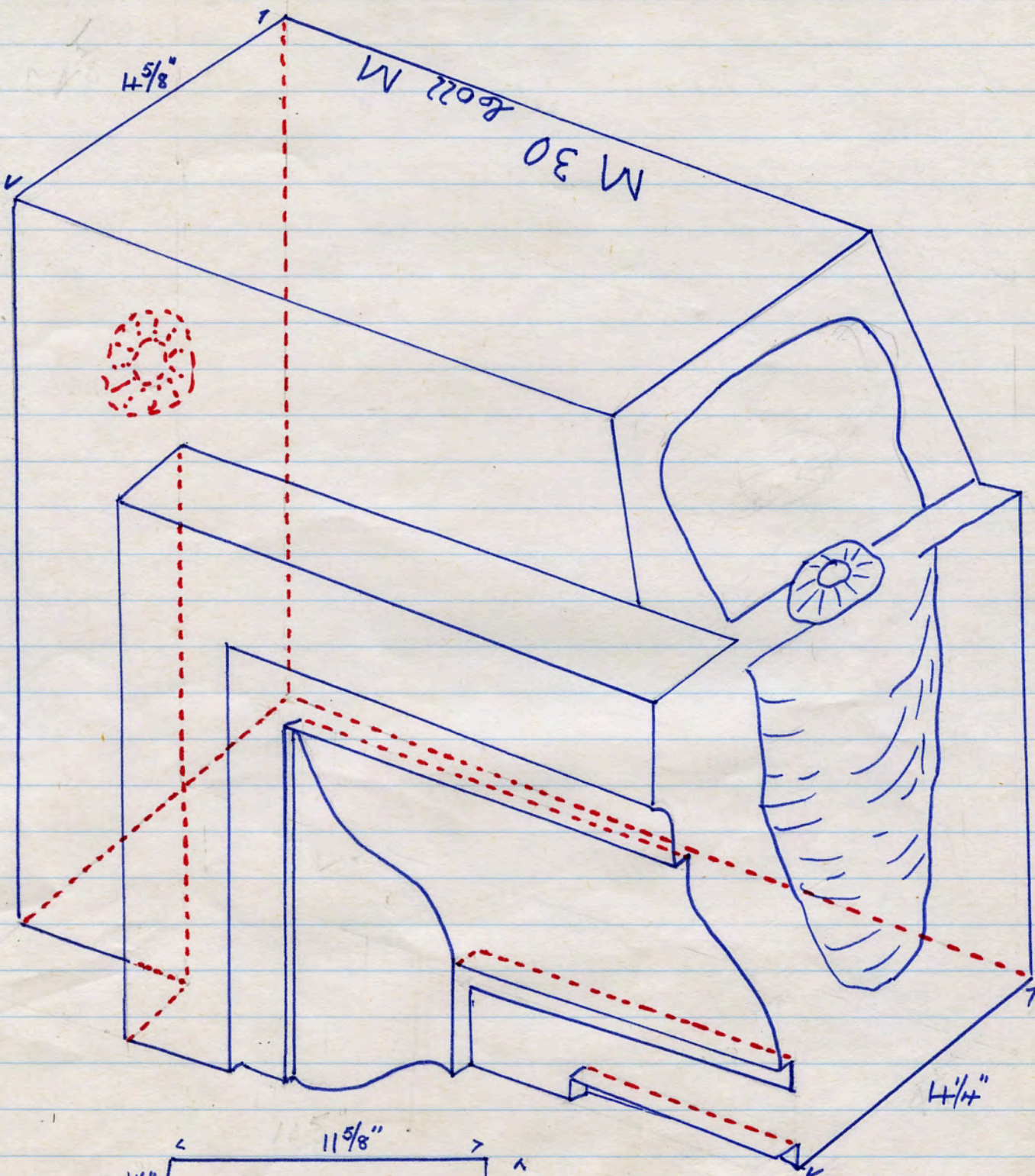

Architrave mould 4" x 2"

St Mary's Hospital dem-porch.
Whitworth St. W/n 18. 9. '88

ACCRINGTON B & T G^o L^o red
10 lbs. 9" x 4 1/2" x 3"

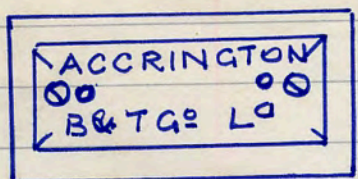

single panel each side.

3684

letters incised obv.

note G for C in G^o, + C in new L^o

18. 8. '88

Internal alterations at Hareholme Prim. Methodist Chapel

LANCASHIRE BRICK CO BAXENDEN ACCRINGTON.

9 lbs. 9" x 4 3/8" x 3 1/8"

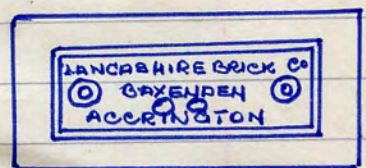

single panel each side.

letters incised obv.

Park Lane Cottage, Holcombe Rd. H/shore. 3. 9. '88

ACCRINGTON NORI red. 1/4 bullnose.

8 lbs. 9" x 4 3/8" x 2 1/2"

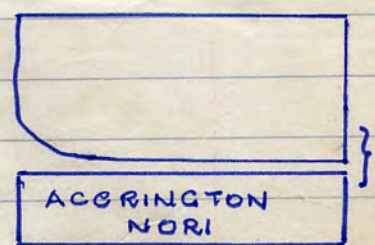

no panels, letters stamped, 1 edge.

Acc/ton Nori dem. site. 16. 10. '88

B X red slosser

5 1/2 lbs. 8 3/16" x 2 7/8" x 2"

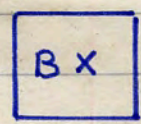

no panels, letters stamped. 1. end.

Acc/ton Nori dem. site. 13. 10. '88

No name. plain red floor tile

7 lbs. 8 3/4" x 4 1/8" x 2 1/16"

no panels, no letters

Acc/ton Nori. dem. site. 16. 10. '88

PO red quadrant.

7 1/2 lbs. 8 3/4" x 4" x 2 3/4"

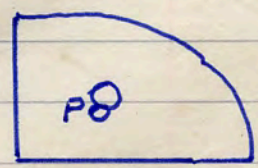

no panels. letters stamped 1 end

1/2" diam. perf. throughout length.

Acc/ton Nori dem. site 16. 10. '88

3715

POYLN red, return end of floor tile
7 lbs. $8\frac{3}{8}$ " x 4" x 2"

3716

no panels. letters stamped on base.

walking surface covered with dots in relief

plain border round edge + 1 side.

Acc/ton Nori

dem. site.

16. 10. '88



NORI D red.

10 1/2 lbs. 9" x 4 1/4" x 3"

small panel 3" x 1 3/4" stamped 1/8" deep.

3718

letters incised obv. plain rev.

Acc/ton Nori dem. site 13. 10. '88

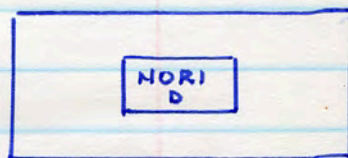

NORI red

10 lbs. 9" x 4 1/4" x 3" - 2 3/4"

3719

small panel each side 3 5/8" x 2" x 3/16"

letters incised obv.

Acc/ton Nori dem. site 13. 10. '88



No name. red squint

8 lbs. $8\frac{5}{8}$ " x $4\frac{3}{8}$ " x $2\frac{1}{8}$ "

3720

single panel obv. only, plain rev.

30 in relief in panel obv.

Acc/ton Nori dem. site 16. 10. '88

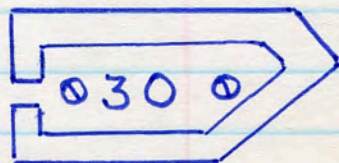

NORI D2 red. purpose made.

10 lbs

3721

panel stamped obv. letters incised

Acc/ton Nori dem. site 16. 10. '88

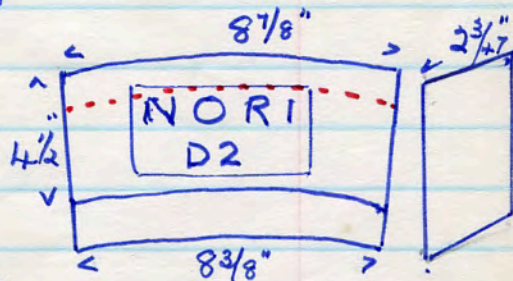

No name 86 red T.C one course ornamental stretchers

3722

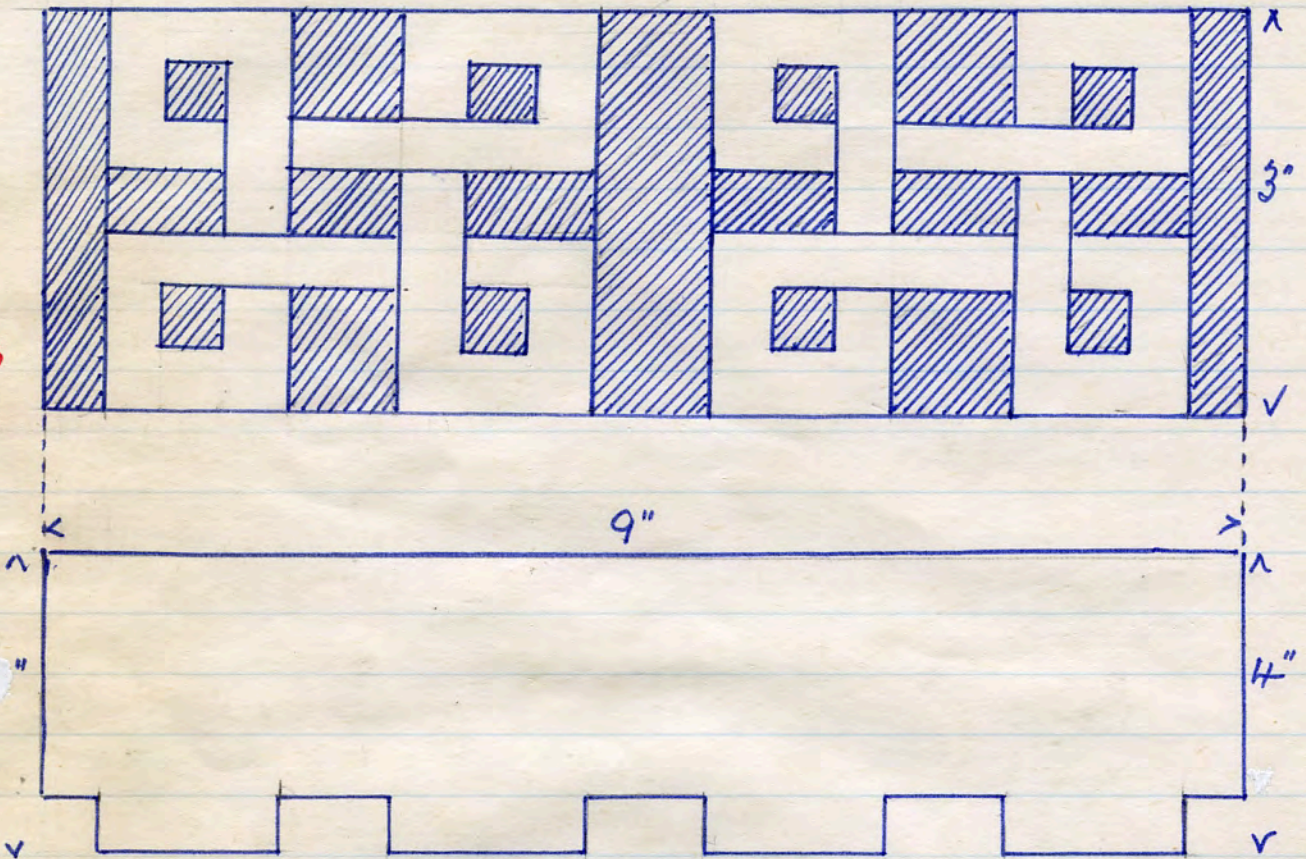

Projection of pattern $\frac{1}{2}$ "

9 lbs. Acc/ton Mori dem. site 16. 10. '88

no panels. 86 stamped on 1 end.

In catalogue no 3 of The Kenfield Brick & Terra cotta Co. Ltd this brick is entered as no. 55.

No name. 57

9 lbs.

red T.C jamb.

9" x 4 1/2" x 3 1/8"

3723

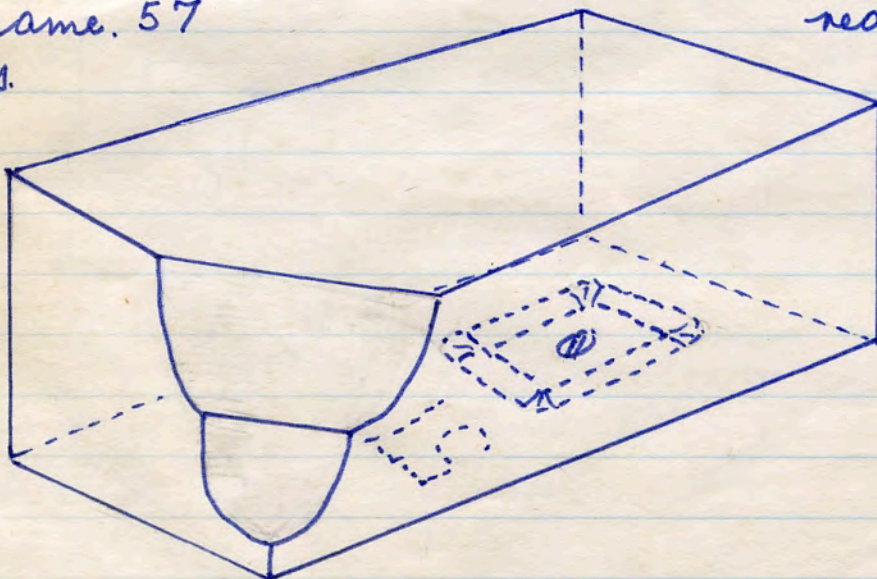

(manufactured by Kenfield Brick & Terra cotta Co. Ltd).
Acc/ton Mori. dem. site 16. 10. '88

No name
10 1/2 lbs

red T.C. jamb.
9" x 4 1/2" x 3 1/4"

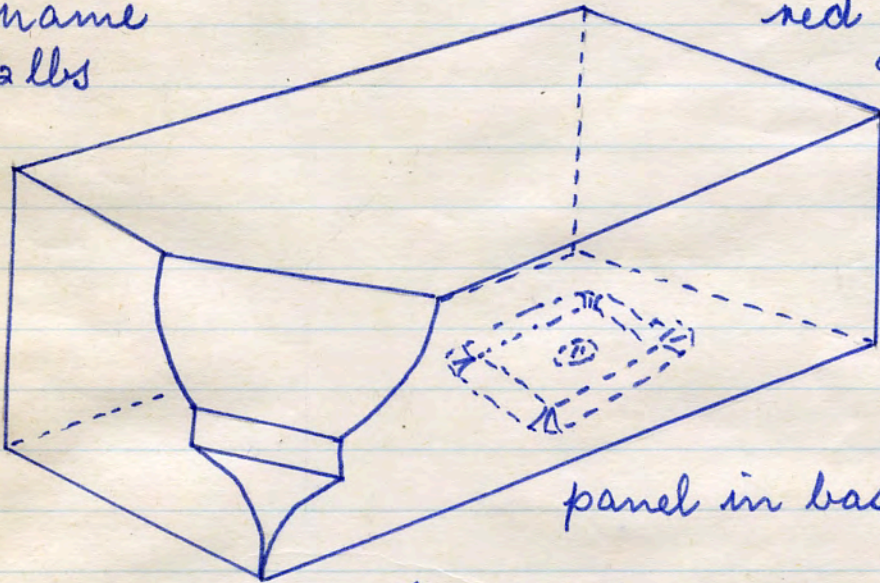

panel in base

3724

(Manufactured by Enfield Brick & Terra Cotta Co. Ltd)
Acc/ton Mori dem. site No. 10. '88

No name 60
10 lbs.

red T.C. jamb.
9" x 4 1/2" x 3 1/8"

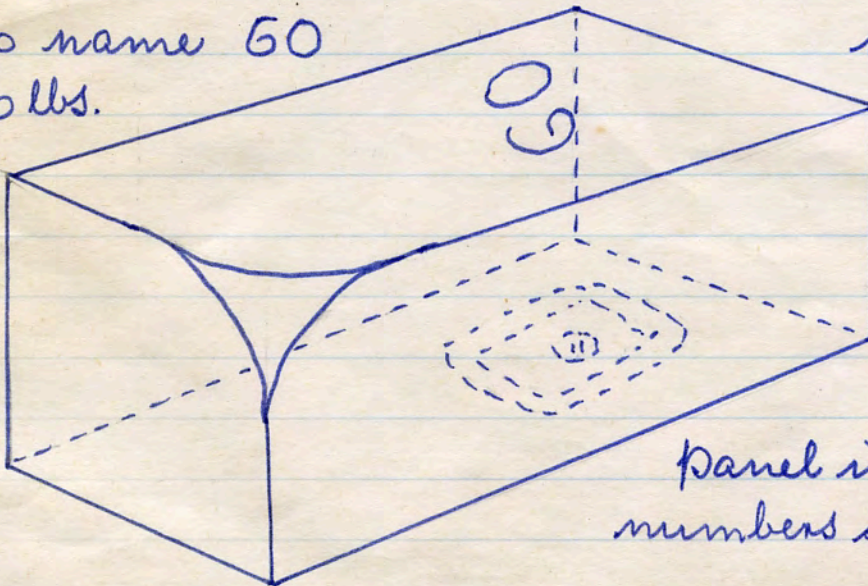

panel in base.
numbers scribed on top.

3725

specification as above.

No name. 2331L

red T.C. jamb
8 3/4" x 4 1/8" x 2 3/4"

3726

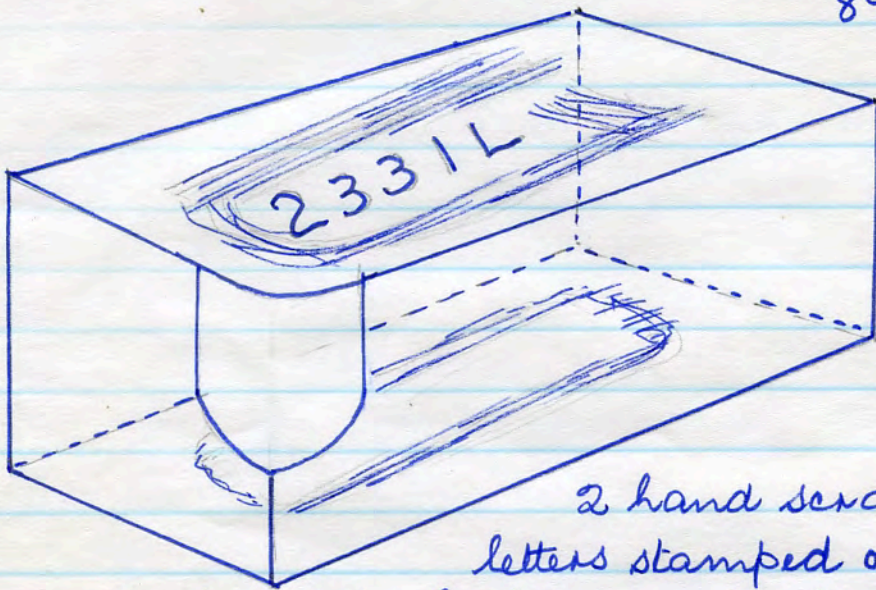

2 hand scraped panels
letters stamped on top.

(manufactured by Enfield Brick + Terra cotta Co. Ltd)
Acc/ton Nori. dem. site 16. 10. '88

No name 222 red T.C wire sun wall cap.
10 lbs. 12 1/4" x 6" x 2 1/2"

no panels. letters stamped 1 side
2 perfs 1" diam. 2 x 3/4" water drips 1 x 3/4" half round
fixing slit in base

3728

Acc/ton Nori. dem. site 16. 10. '88

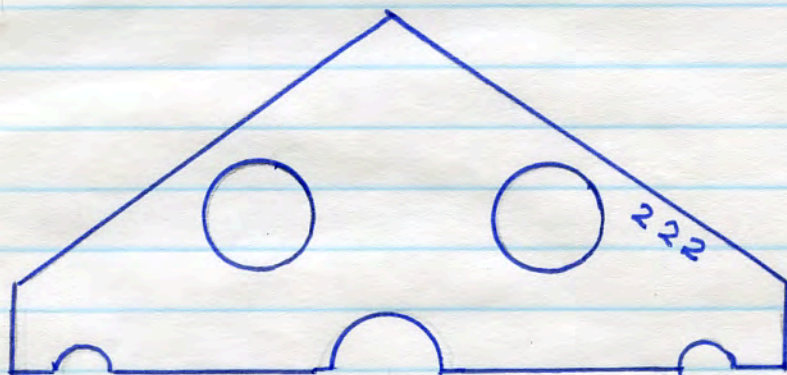

ACCRINGTON NORI red. wire cut
7 lbs. 8 5/8" x 4" x 2 7/8"

no panels, sand faced 1 face edge 2 ends.

14 perfs 3/4" diam. 2 perfs 1/2" diam.

letters stamped on edge.

Acc/ton Nori. dem. site 20. 10. 88.

3727

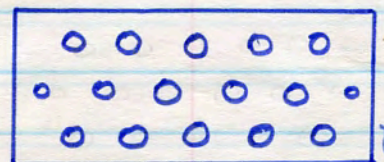

ACCRINGTON
NORI
ACCRINGTON
NORI

No name. 24 52A red T.C. jamb, wire run.
7 lbs. $8\frac{3}{4}" \times 4\frac{1}{8}" \times 2\frac{5}{8}"$

3729

no panels, numbers stamped 1 side.

2 perfs. 1" diam.

Acc/ton Mosi dem. site. 16. 10. '88

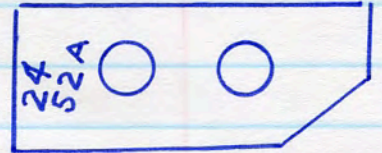

No name 24 22 red T.C. dogleg.
8 lbs. 140°

3730

no panels, numbers stamped 1 side

2 perfs 1" diam.

Acc/ton Mosi dem. site

16. 10. 88

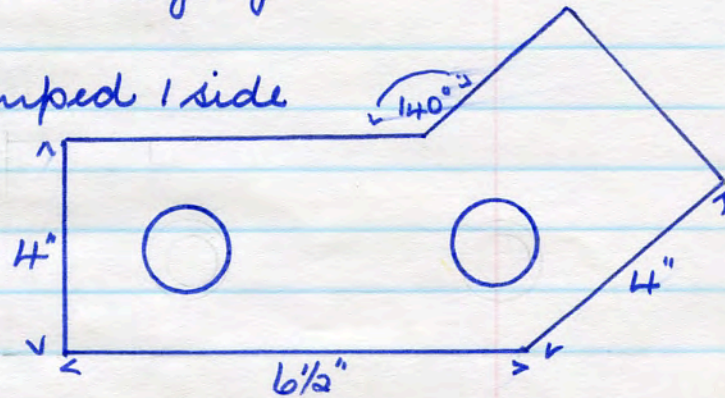

No name. 04 red T.C. jamb with reveal.
8 1/2 lbs. $9" \times 2\frac{3}{4}"$

3731

single panel 1 side only.

1 perf 1" diam, 2" deep in rev.
numbers in relief in panel.

20. 10. '88

Acc/ton Mosi dem. site

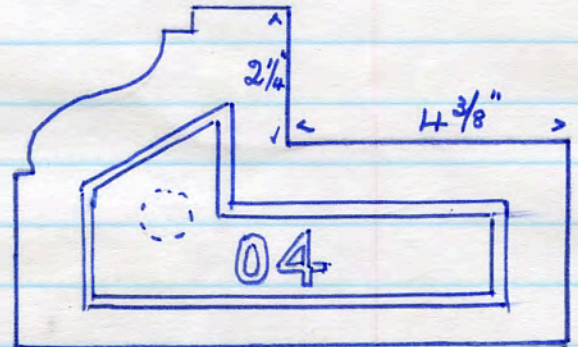

No name. 67 red T.C. single course dec. stretchers,
weathered on top face.

3732

12 1/2 lbs. $9" \times 5\frac{7}{8}" \times 2\frac{7}{8}"$

no panels, numbers stamped on 1 end

Acc/ton Mosi dem. site. 20. 10. '88

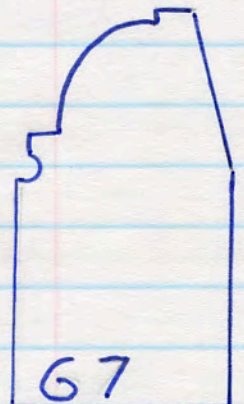

No name. red T.C. single course moulded +
weathered stretchers with weathered return
12 lbs. 9" x 6" x 3"
no panels.

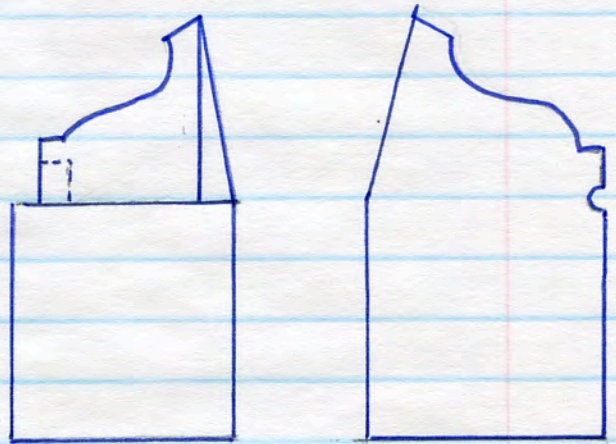

3733

Acc/ton Mori dem. site
(from dem. of buildings
of A B + T. C. LTD.)
20. 10. '88

No name D2H red T.C. bull nosed floor tile
2 lbs 4" x 4" x 2"
no panels. letters stamped on end

3734

Acc/ton Mori dem. site 20. 10. '88

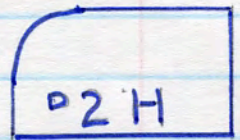

No name. PNGB red T.C. internal angle skirting
5 lbs 5" x 2" on 5" x 5" platform base.
no panels. letters stamped on 1 side

3735

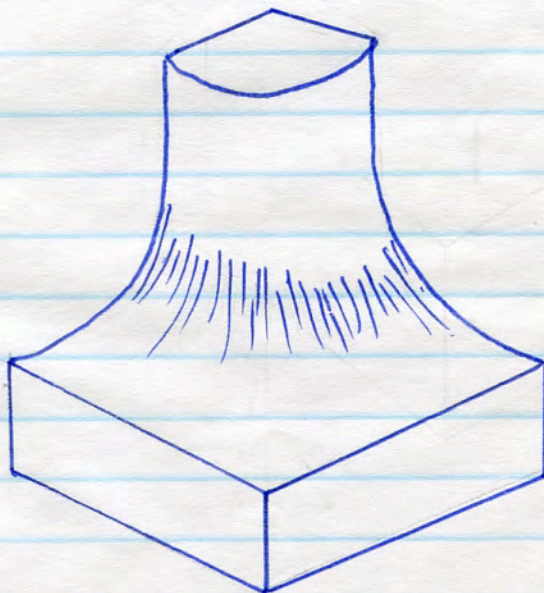

Acc/ton Mori dem. site. 20. 10. '88.

No name. 2A 61 red T.C. double splay level
7 lbs. $8\frac{5}{8}" \times 4" \times 2\frac{5}{8}"$

3736 no panels. numbers stamped 1 side
2 perfs 1" diam.

Acc/ton Mori dem. site 20. 10. '88



No name 351 T4 red T.C. radial header. tapered for
7 lbs. $8\frac{3}{4}" \times 4\frac{1}{8}" \times 2\frac{5}{8}" - 1\frac{1}{8}"$ straight gauged work

3737 no panels. numbers stamped 1 side
Acc/ton Mori dem. site 20. 10. '88

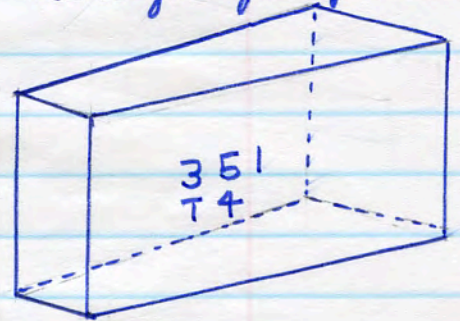

ARMITAGE red T.C. quarter round return stretcher
7 lbs $8\frac{3}{4}" \times 3\frac{7}{8}" \times 2\frac{1}{2}"$

3738 single panel in rev. + name in countersunk panel.
letters incised



Acc/ton Mori dem. site 20. 10. '88

No name. 2512 R. red T.C. splay (bevel) stop
8 lbs. $8\frac{1}{2}" \times 4\frac{1}{16}" \times 2\frac{5}{8}"$

3739 no panels. numbers stamped 1 side
Acc/ton Mori. dem. site 20. 10. '88.
all edges pencil moulded.

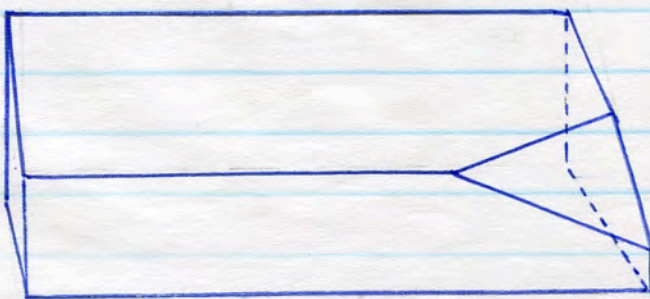

3740

No name. 2512 R as No 3739
+ 2 perfs $\frac{5}{16}$ " diam. 8 lbs
Acc/ten Mexi. dem. site 20. 10. '88

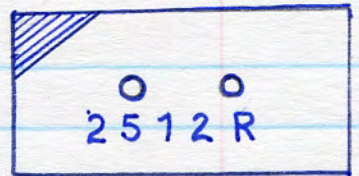

No name. 231 42 X R red T.C semi circular
internal return.

$7\frac{1}{2}$ lbs. $8\frac{1}{2}$ " x 4" x $2\frac{3}{4}$ "

no panels. 3 fixing holes $\frac{3}{16}$ " diam. in base
numbers stamped on base.

Acc/ten Mexi. dem. site 20. 10. '88

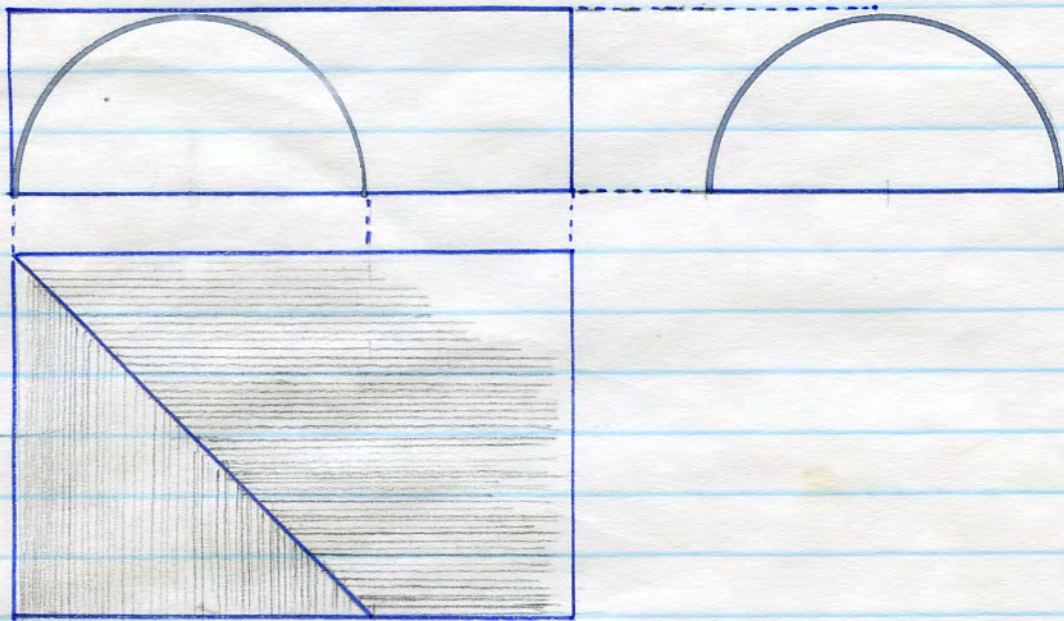

3741

No name. 99 red T.C. segment of circle
7 lbs. $9\frac{1}{4}$ " x $4\frac{1}{2}$ " x $1\frac{1}{8}$ "

3742 no panels. 1 side grooved. 1 tongued.
numbers stamped 1 end.

Acc/ten Mexi dem. site 23. 10. '88

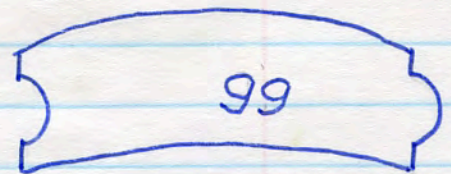

No name. 35 5T red T.C radial header

$7\frac{1}{2}$ lbs. $8\frac{5}{8}$ " x 4" \otimes $2\frac{3}{4}$ " x $2\frac{1}{8}$ "

3743 no panels. numbers stamped 1 side.

Acc/ten Mexi. dem. site 20. 10. '88

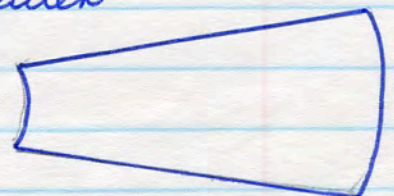

No name. ISP red T.C exterior angle skirting.
 7 1/2 lbs. 8" x (1 1/4" x 1 1/4") x (2 3/4" x 2 3/4") x (1" x 1" rebate)

3744

no panels. letters incised 1 side
 Acc/ton Mori dem. site 20. 10. '88.

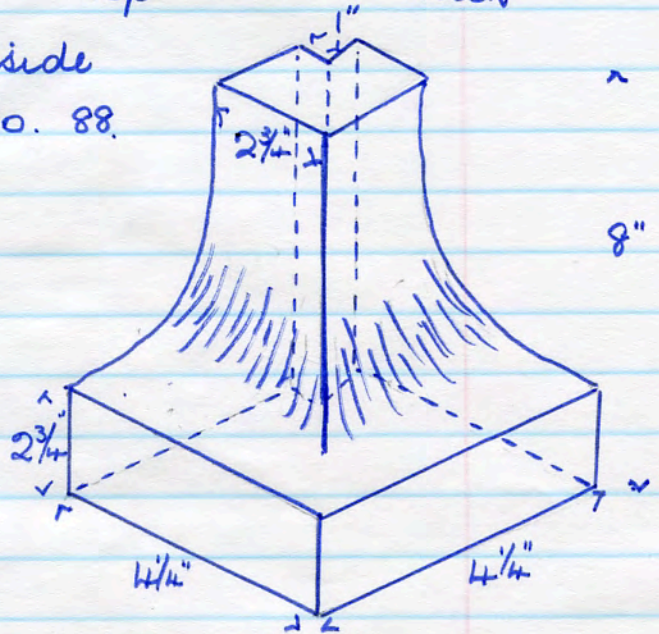

No name. 1P red T.C skirting (for above)
 10 1/2 lbs. 8 5/8" x 6" x 3"
 no panels. letters stamped rev.

3745

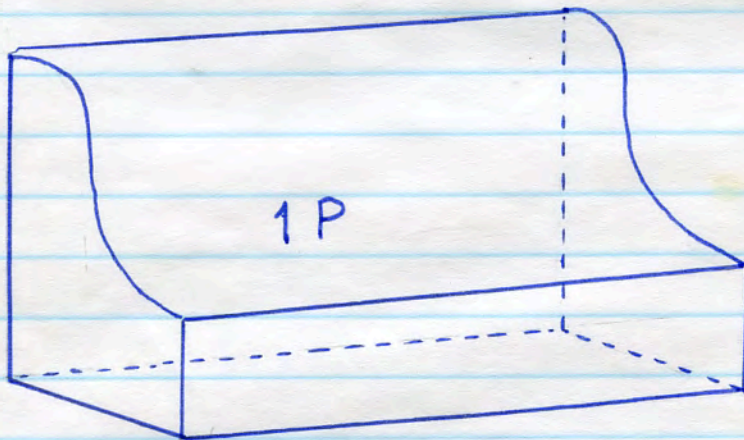

Acc/ton Mori dem. site 23. 10. '88

No name. POE red T.C block.
 5 1/2 lbs. 8 1/2" x 4 1/8" x 2"
 no panels. letters stamped rev.

3746

Acc/ton Mori dem. site 23. 10. '88

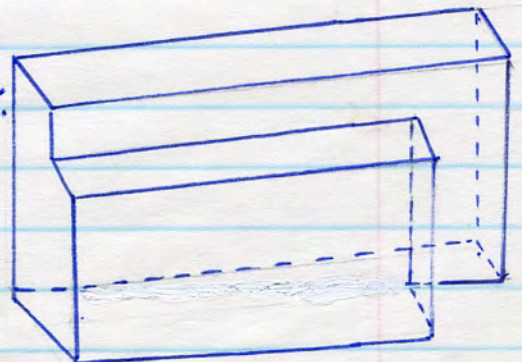

3747 No name 2 2 2 L red T.C. wall capping.
 7 1/2 lbs. 8 3/8" x 6" base to high pt. x 2 1/2"
 no panels. 2 water grooves 1/2" diam.
 centre fixing groove 1" diam. 1 perf 1" diam
 numbers stamped on 1 end
 Acc/ton Mori dem. site 20. 10. '88

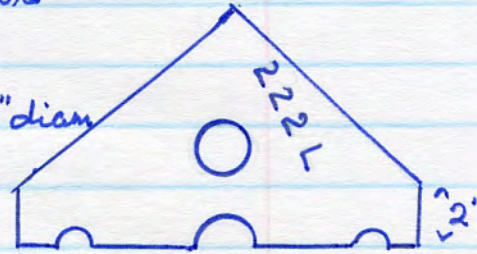

3748 No name. 2 4 4 3 red T.C. bindsmouth
 8 lbs. 8 1/4" x 4 1/8" x 2 1/2"
 no panels. numbers stamped base.
 Acc/ton Mori dem. site 23. 10. '88

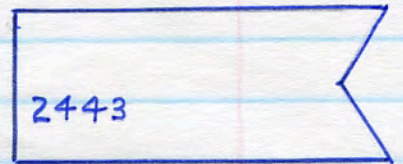

3749 No name. 2 5 3 1 red T.C. plinth stretcher.
 7 lbs 8 5/8" x 4" x 2 9/16"
 no panels. numbers stamped on 1 end
 Acc/ton Mori dem. site 23. 10. '88

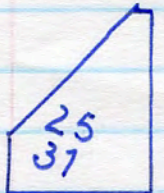

3750 No name. A S B red T.C. plinth header
 7 lbs. 8 1/2" x 4 1/8" x 2 5/8"
 no panels. letters stamped on 1 end
 Acc/ton Mori dem. site 23. 10. '88

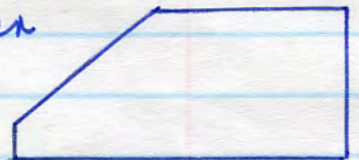

3751 No name. P Z X S R red T.C. triple bullnose - face
 edge & 2 ends.

9 lbs 8 3/4" x 4 1/4" x 3"
 no panels. 6 perfs (1/2 way) 1/4" diam
 letters stamped on base
 Acc/ton Mori dem. site 23. 10. '88

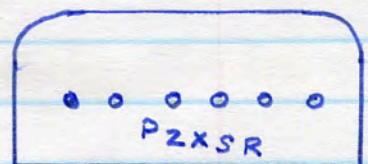

No name PZER red T.C. ^{exc} internal return bullnose
16 lbs $8\frac{1}{2}" \times 8\frac{3}{8}" \times 2\frac{3}{4}"$

3752

no panels. letters stamped 1 end
Acc/ton Mori dem. site 23. 10. '88.

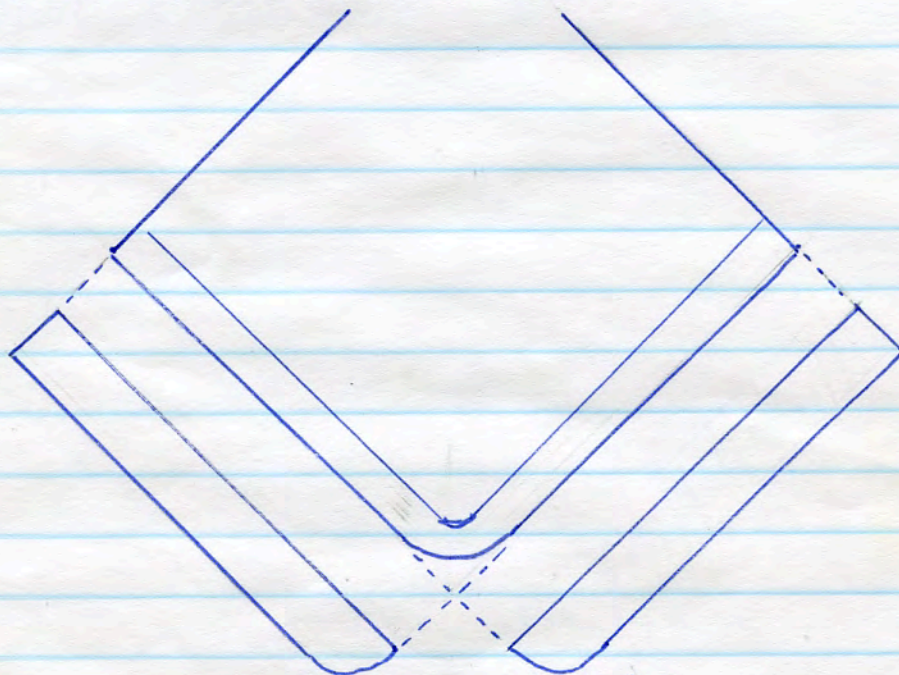

No name. PE 24
 $6\frac{1}{8}"$

red T.C 4 way
junction
24 lbs.

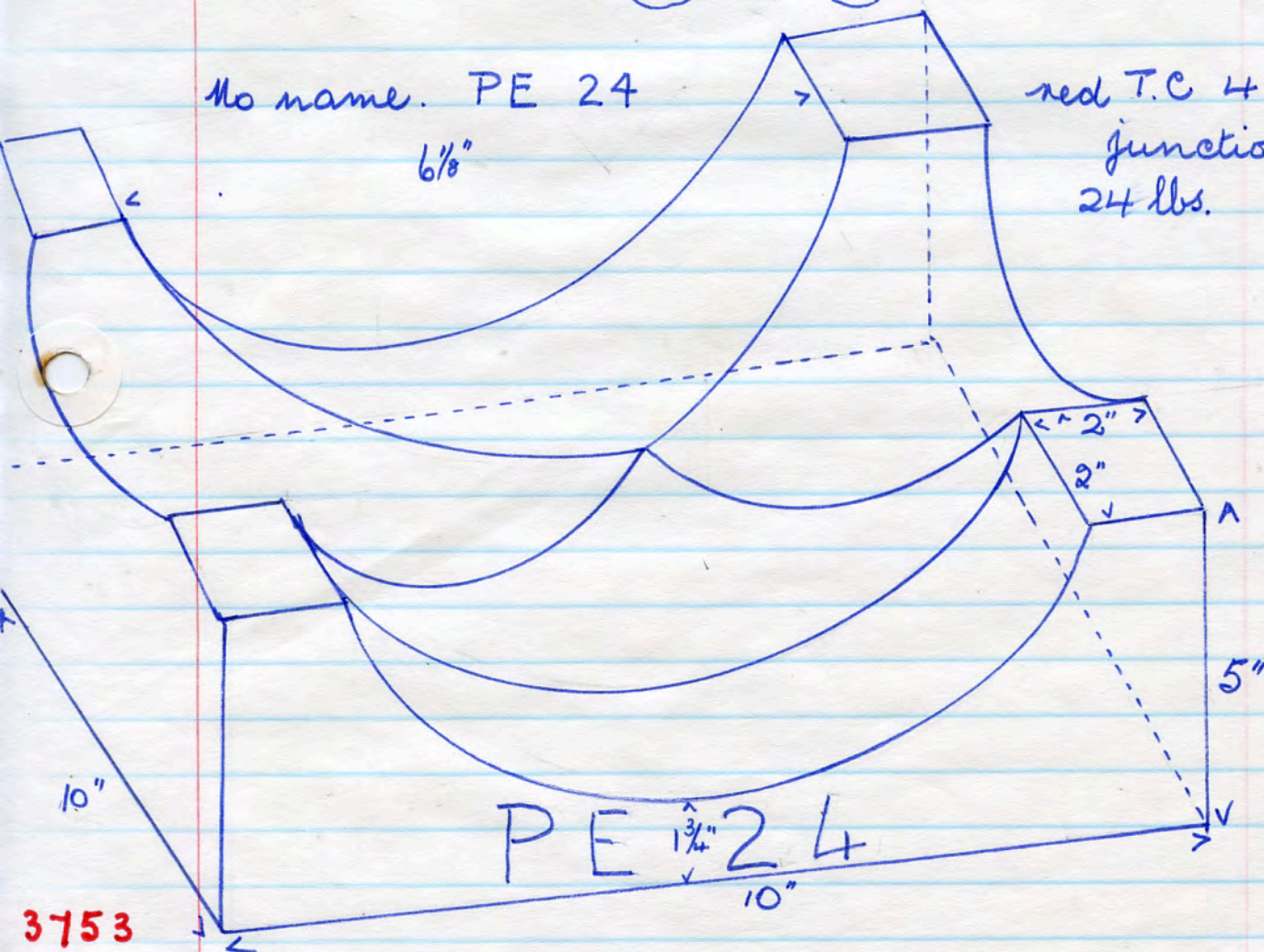

3753

Acc/ton Mori dem. site 23. 10. '88

No name PN 7AB red T.C. corner of dish
8 lbs. 5" x 5" x 5"

no panels. letters incised 1 end.

3754 Acc/ton Mori dem. site 23. 10. '88

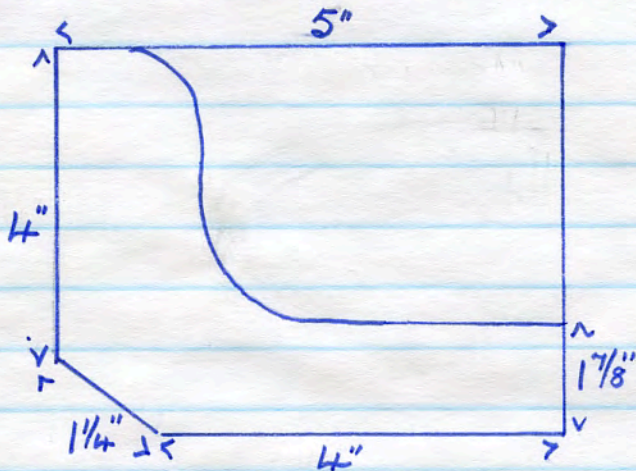

No name 15 red T.C. rebated jamb (rebate 1 1/2" x 1")
7 1/2 lbs. 8 1/2" x 4" x 2 3/4"

fixing hole throughout length 3/8" diam.

3755 no panels. numbers stamped 1 end.

Acc/ton Mori dem. site 23. 10. '88

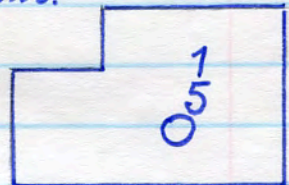

No name 258 5L red T.C. external splay.

6 1/2 lbs 6 1/2" x 4" x 2 1/2"

4 stud holes for fixing 3/16" diam.

3756

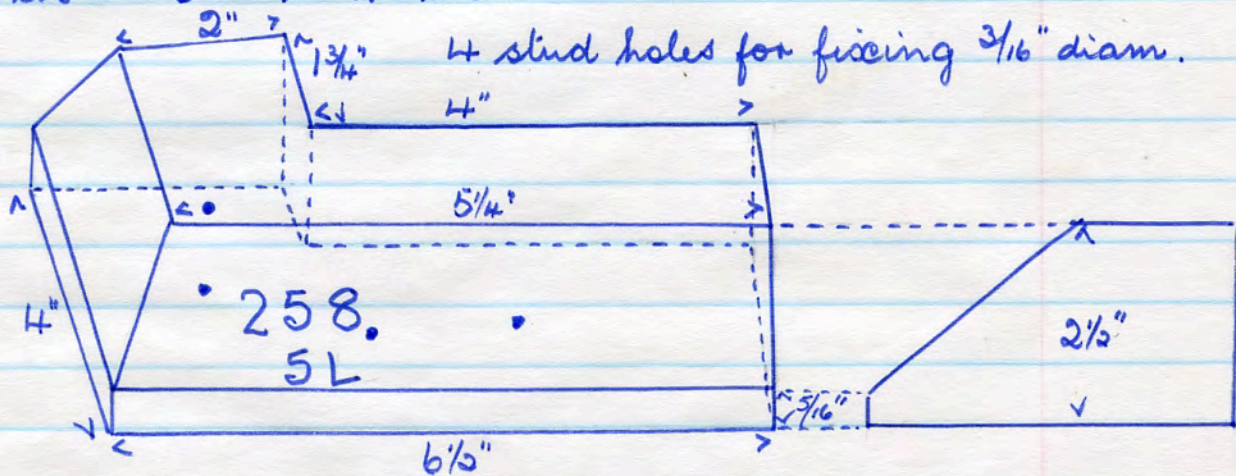

numbers stamped on base

Acc/ton Mori dem. site 23. 10. 88.

No name 2563 L red T.C. internal splay.
8 lbs

3757

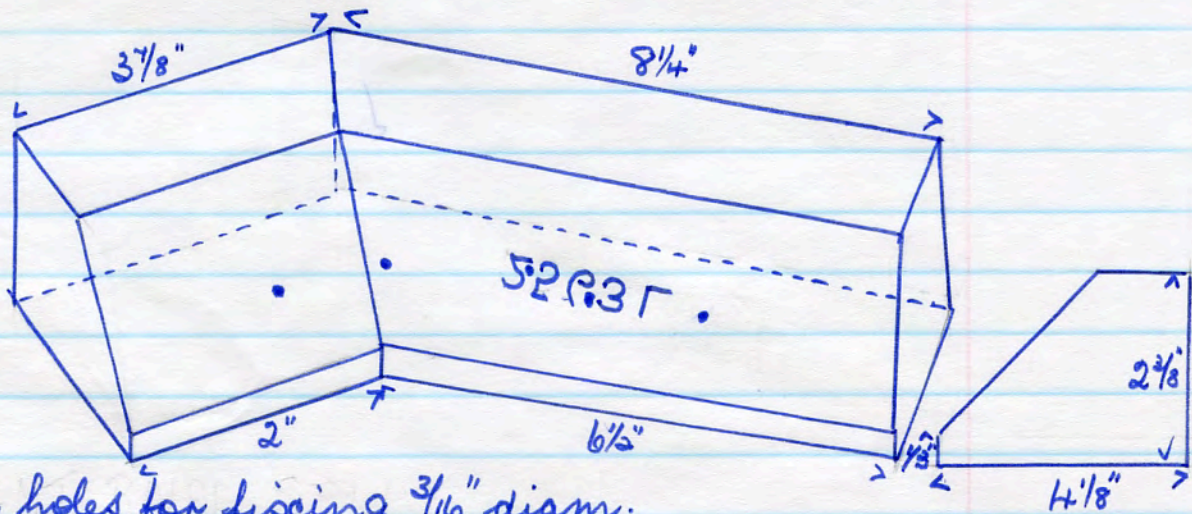

5 stud holes for fishing $\frac{3}{16}$ " diam.
letters & numbers stamped on base.
Acc/Kon Mori dem. site 23. 10. '88

No name. 8 POD red T.C. floor ^{tile} studded & rebated
6 lbs.

3758

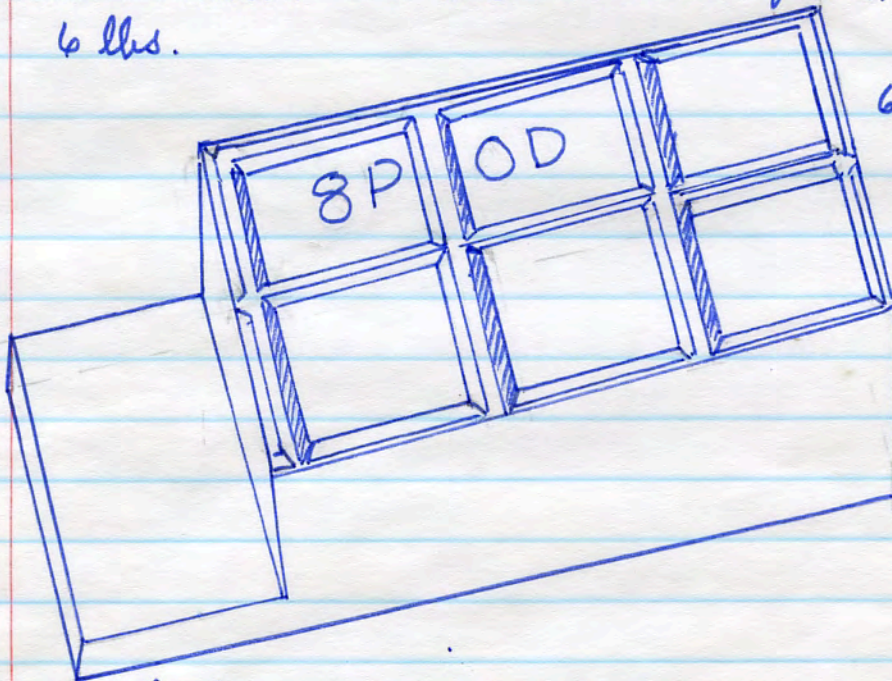

$8\frac{3}{8}$ " \times $4\frac{1}{8}$ " \times $1\frac{7}{8}$ "
6 studs $1\frac{7}{8}$ " \times $1\frac{7}{8}$ " \times $\frac{3}{16}$ "
rebate $4\frac{1}{8}$ " \times 1"
letters stamped on
1 edge

Acc/Kon Mori dem. site 23. 10. '88

No name 2310 21-7R red T.C. bullnose stop end +
in section

8 lbs $8\frac{1}{2}" \times 4\frac{1}{8}" \times 2\frac{3}{16}"$

numbers stamped on rev.

3759 5 stud holes for fixing $\frac{3}{16}"$ diam.

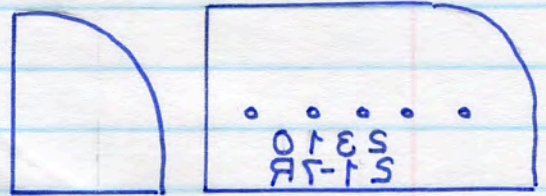

Acc/ton Mori dem. site 23. 10. '88

No name GA3 red T.C tapered

3760 9 lbs. $5\frac{1}{4}" + 5" \times 2\frac{3}{4}"$ (1 end) + $1\frac{3}{4}"$ (2nd end) $\times 4"$ (2nd) $\times 4\frac{3}{8}"$ (1st)
letters stamped on big end.

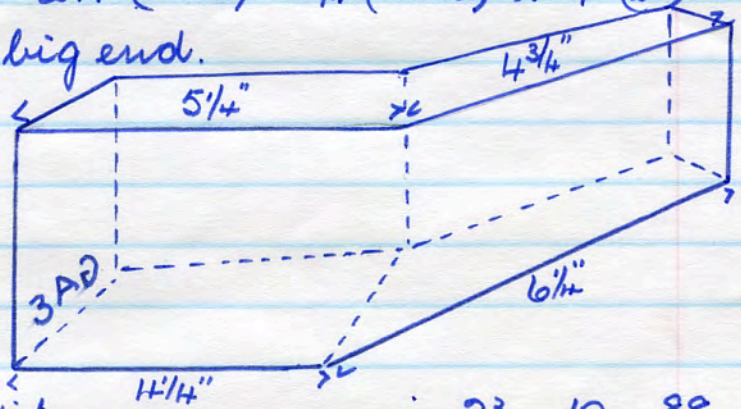

Acc/ton Mori dem. site

23. 10. 88

No name. J8 red T.C. tapered.

3761 10 lbs

letter + number
stamped on 1 end

Acc/ton Mori dem.
site 23. 10. 88

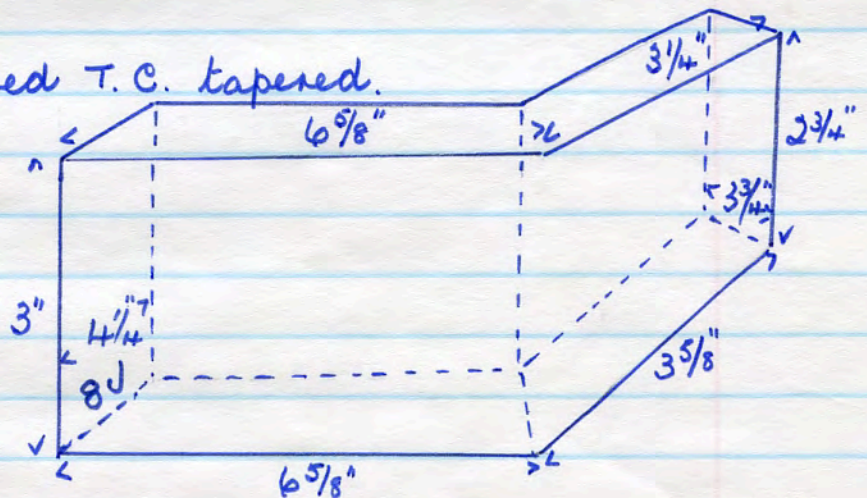

No name. 24 13 red T.C. squint

$6\frac{1}{2}$ lbs $7\frac{1}{2}" \times 4\frac{3}{16}" \times 2\frac{1}{2}"$

3762 no panels. letters stamped 1 end

2 perfs. $\frac{7}{8}"$ diam.

Acc/ton Mori dem. site 20. 10. '88

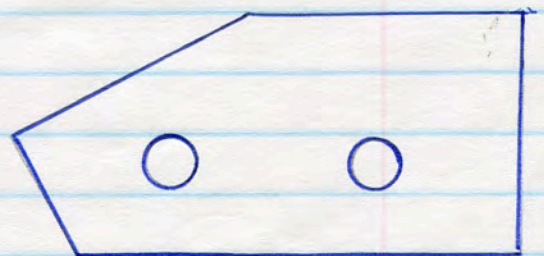

No name. red T.C. double bullnose.

9 lbs. $8\frac{5}{8}" \times 4\frac{1}{4}" \times 2\frac{1}{16}"$

3763

no panels.

Acfton Noni dem. site

20. 10. 88.



No name 314 TH red T.C.

10 lbs $8\frac{5}{16}" \times 7\frac{3}{4}" \times 2\frac{1}{2}"$

3764

$\frac{5}{16}"$ weather groove

20. 10. 88

Acfton Noni dem. site

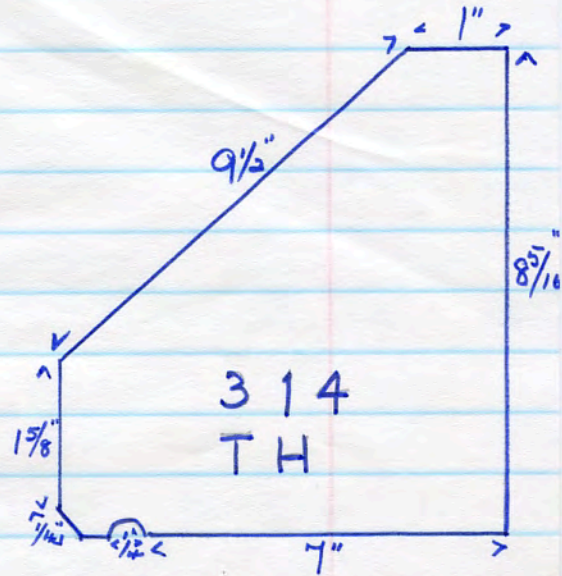

No Name. red T.C semi circular wall cap.

14 lbs. $12" \times 6" \times 2\frac{1}{2}"$

3765

no panels. 2 perfs 1" diam.

1 water groove 1" diam

2 " " $\Delta \frac{3}{8}"$ "

Acfton Noni dem. site

23. 10. 88

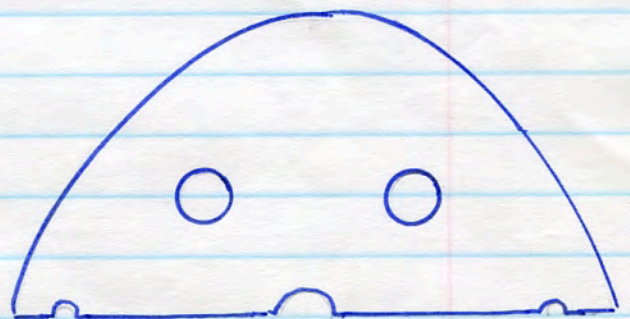

No name. dark brown T.C floor tile

5 lbs. $8\frac{1}{4}" \times 4\frac{1}{8}" \times 1\frac{1}{2}"$

3766

no panels 8 studs $1\frac{9}{16}"$ square

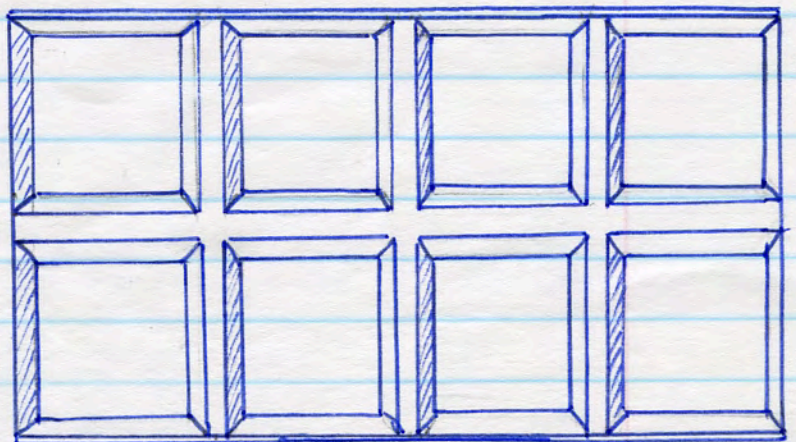

No name 147 TAL dark brown T.C dog leg
5 lbs.

no panels. 2 perfs $3/4$ " diam.
letters stamped 1 side

3767

24. 10. '88

Acc/ton Mori dem. site

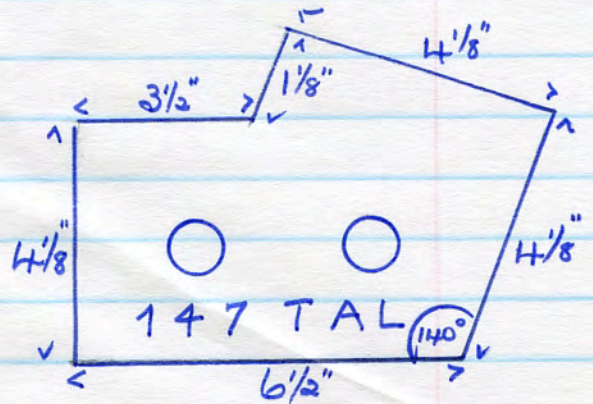

No name. 147 T3 dark brown T.C. bull nose
5 lbs. $6 3/4$ " x 4" x $2 3/8$ "

no panels. letters stamped 1 end.
Acc/ton Mori dem. site

3768

24. 10. '88

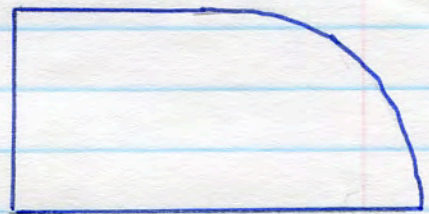

No name 147 T4 dark brown T.C.
 $2 1/2$ lbs 4 " x 4 " x $2 1/2$ "

no panels, letters stamped 1 side

3769

Acc/ton Mori dem. site 24. 10. '88
small bull nose.

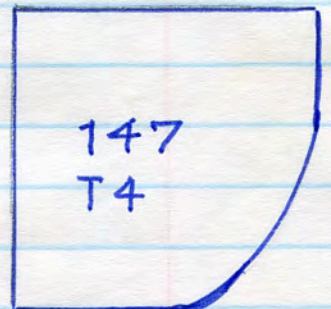

No name 7L red T.C. stop chamfer stretcher, internal
8 lbs. $8 1/2$ " x 4" x 3"

no panels. 5 x $3/16$ " diam. stud holes for fixing.
stamped on base.

3770

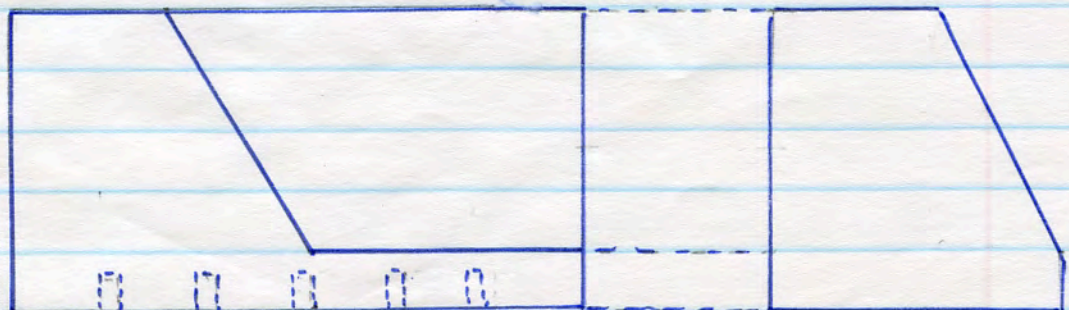

Acc/ton Mori dem site. 24. 10. 88.

No name. red T.C. circular divider with centre support
7 7/8" diam. 1 1/8" wall thickness
9 lbs 5 5/8" internal diam. 3 7/8" depth

3771

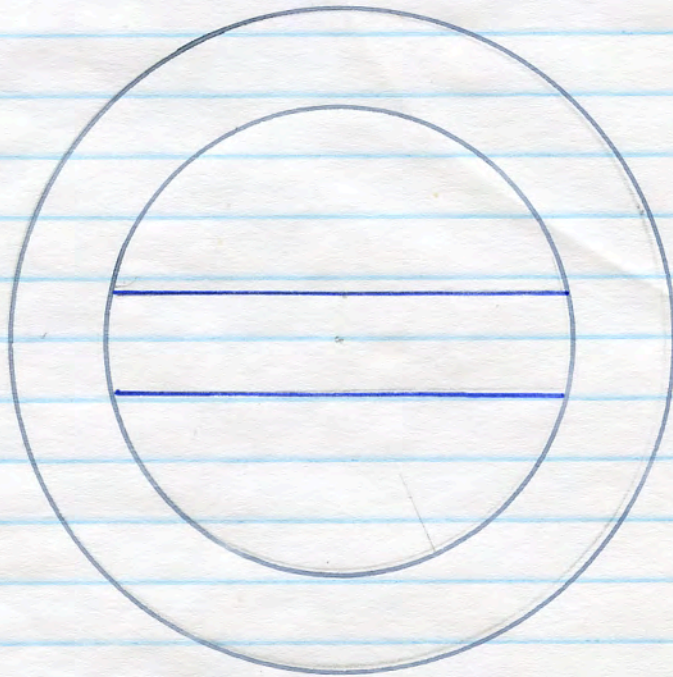

Acc/ton Moni dem. site 24. 10. 88.

No name I O L red T.C skirting return
12 lbs. 8 5/8" x 8" x 1 3/4" to 3 1/4" (base)

3772

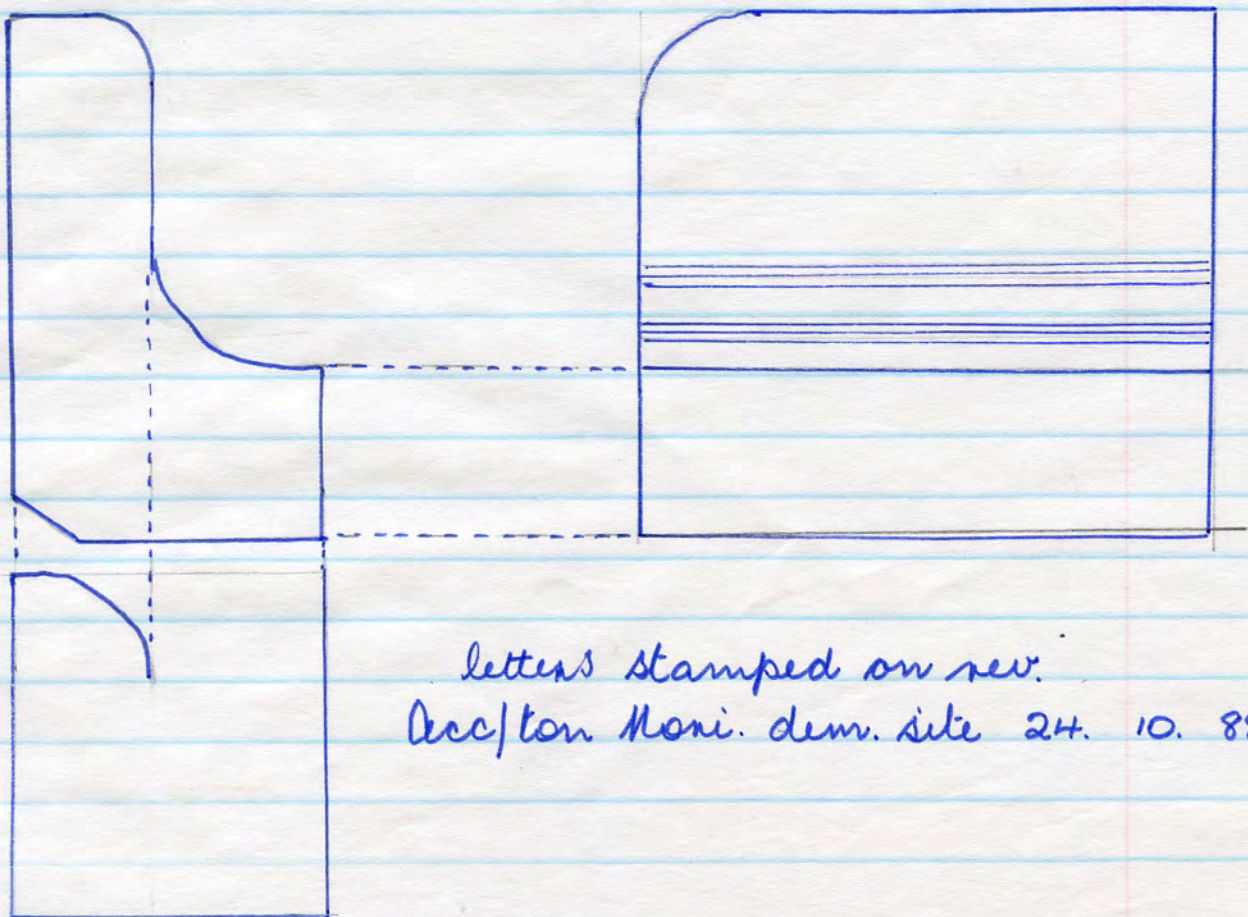

letters stamped on rev.
Acc/ton Moni. dem. site 24. 10. 88.

No name 231 42 red T.C. semi circular stretcher
 7 lbs. $8\frac{1}{2}'' \times 4'' \times 2\frac{9}{16}''$ (not a true semi circle)
 letters stamped on 1 end
 no panels.

3775

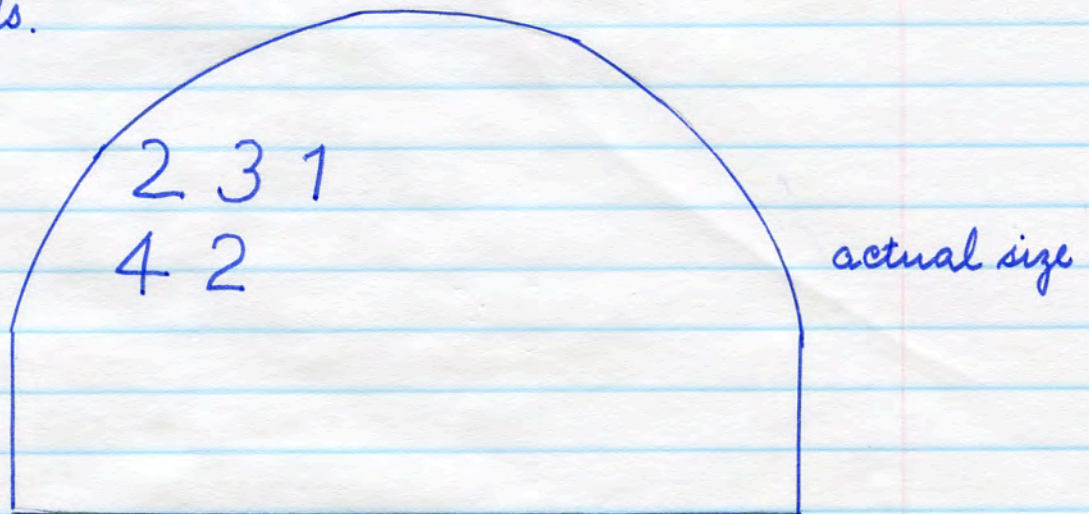

Acc/ton Mori dem. site. 25. 10. '88

No name 17 OT red T.C purpose made stretcher.
 12 lbs. letters stamped 1 side
 no panels.

3776

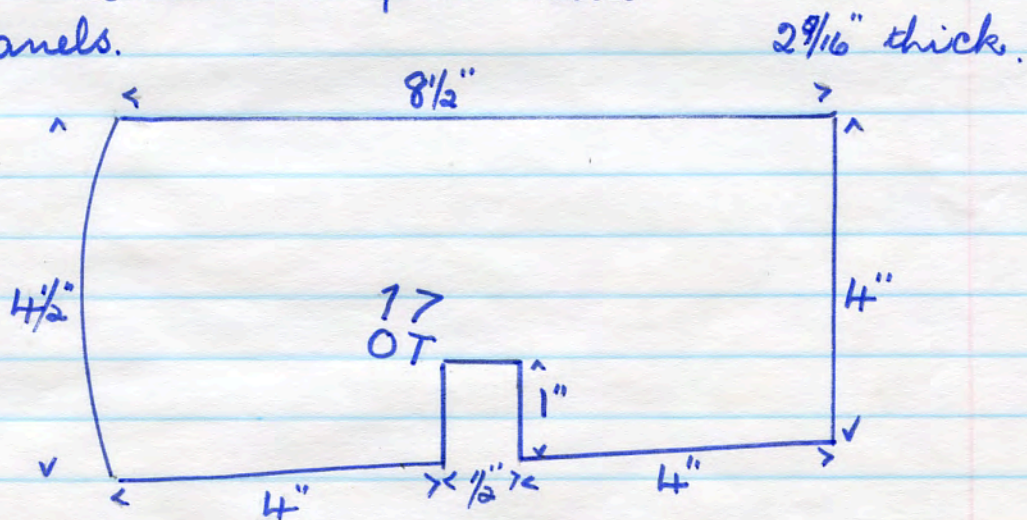

Acc/ton Mori dem. site 25. 10. '88

3777

No name 24 1 red T.C header sill piece
 $3\frac{1}{2}$ lbs. $4'' \times 5\frac{3}{4}'' \times 2\frac{1}{2}''$
 no panels. letters stamped 1 end
 $\frac{3}{4}''$ diam. throating.

Acc/ton Mori dem. site 25. 10. '88

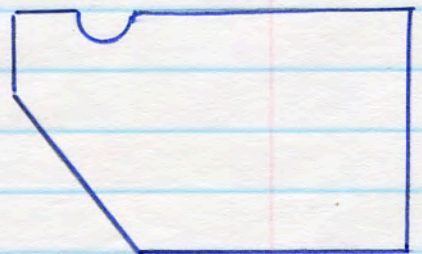

No name. 2462 S HALF. red T.C. dec. stretcher
 10 lbs. $8\frac{1}{2}'' \times 4'' \times 4''$
 cavity in base (hand scraped) $5'' \times 2'' \times 1''$ deep.
 letters stamped on rev.

3778

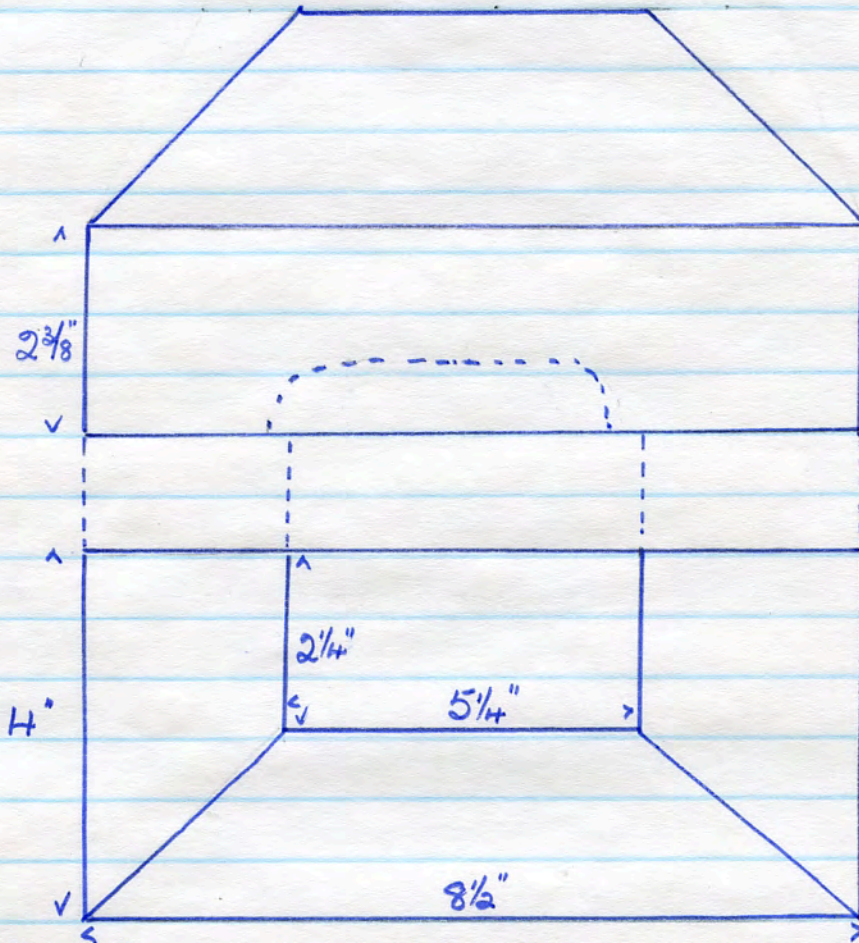

Acpton Nori dem. site 25. 10. 88

No name. red T.C. capping piece
 no panels

3779

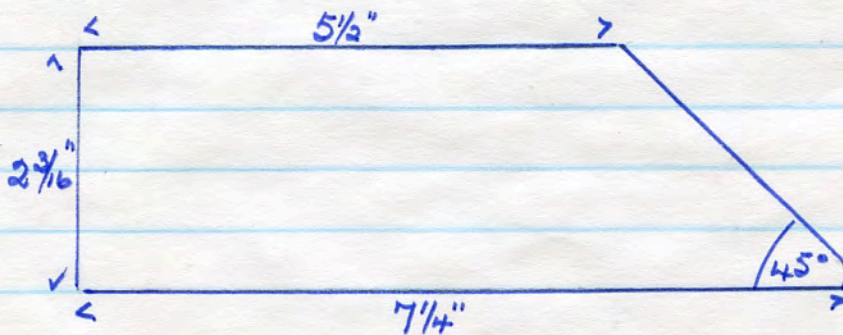

Acpton Nori dem. site 25. 10. 88

No name B H O red T.C. radial king piece header.
10 lbs. $9\frac{1}{8}" \times 4\frac{1}{2}" - 3\frac{3}{4}" \times 3"$

no panels. letters stamped 1 edge

Acpton Mori dem. site 25. 10. 88.

3780

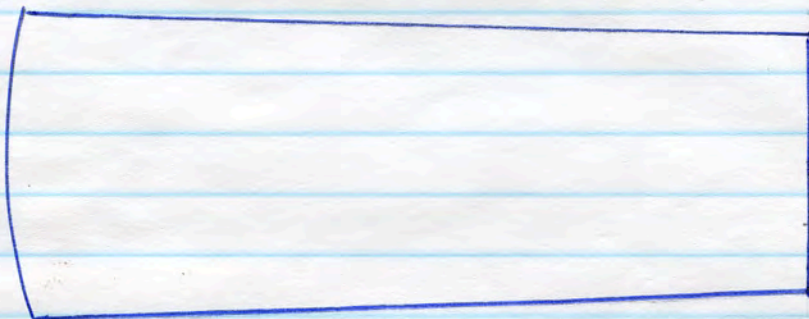

No name. 241 2EL dark brown squint

$3\frac{1}{2}$ lbs. $7\frac{3}{4}" \times 4" \times 2\frac{1}{2}"$

no panels. letters stamped 1 side.

3 perfs 1" diam.

rustic finish 1 end 1 edge

Acpton Mori dem. site 26. 10. '88.

3781

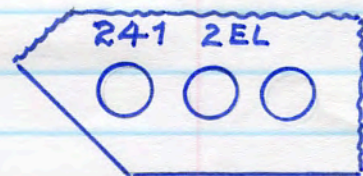

No name. 243 1C dark brown T.C. dog leg.

10 lbs $10\frac{3}{8}" \times 4\frac{1}{4}" \times 3\frac{5}{8}"$

no panels. letters stamped 1 end.

2 perfs 1" diam.

Acpton Mori dem. site 26. 10. '88

3782

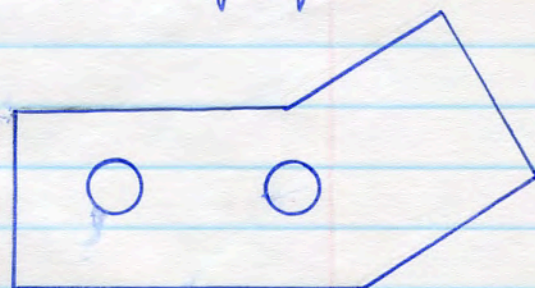

No name. H S red T.C. plinth header.

$6\frac{1}{2}$ lbs $4\frac{1}{8}" \times 3" \times 6\frac{3}{8}"$ wide.

no panels. letters stamped 1 end

Acpton Mori dem. site 26. 10. '88

3783

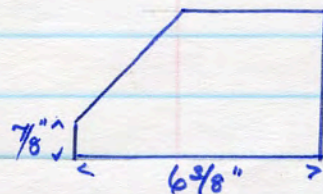

No name. 35 J 5 red T.C. small key for arch.

6 lbs. $5\frac{3}{8}" \times 4" - 3\frac{3}{8}" \times 2\frac{7}{8}"$

no panels. letters stamped 1 end

Acpton Mori dem. site 26. 10. 88.

3785

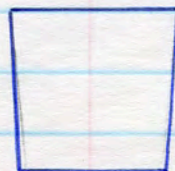

378H

ACCRINGTON NORI closer
7 lbs. $8\frac{3}{4}$ " x $4\frac{3}{8}$ " x 2"

single panel each side
letters incised obs. only.

Direct from kiln at Accrington Nori. dem. site 25. 10. 88.

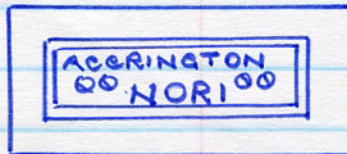

No name. 2382R red T.C. dec return
8 lbs. $8\frac{1}{2}'' \times 14'' \times 2\frac{1}{2}''$
no panels. letters stamped 1 side
2 perfs. $\frac{1}{2}''$ diam.
Acc/ton Mori dem. site 26. 10. '88

3786

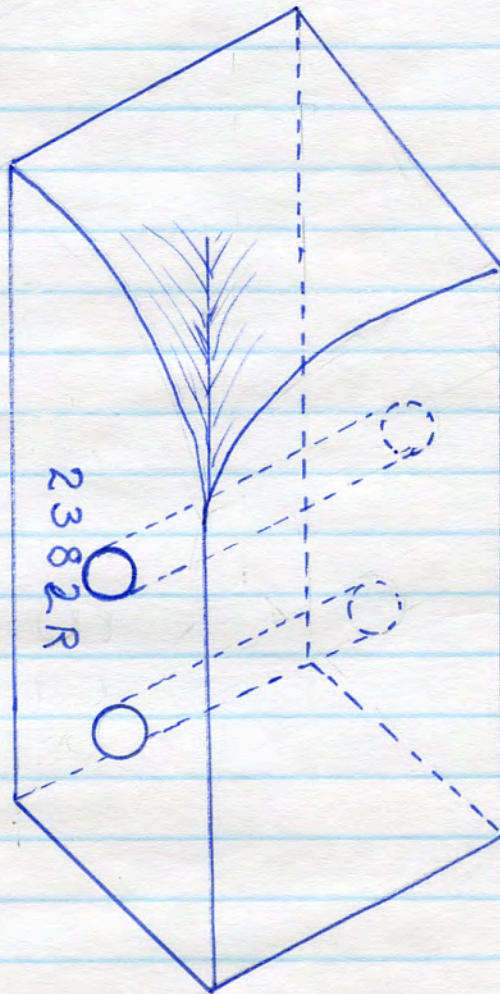

No name CWG1 red T.C. taper
 $2\frac{1}{2}$ lbs. $5\frac{3}{4}'' \times 2\frac{7}{8}'' - 1\frac{3}{8}'' \times 2\frac{1}{8}''$
no panels. letters stamped 1 side
Acc/ton Mori dem. site 26. 10. '88

3787

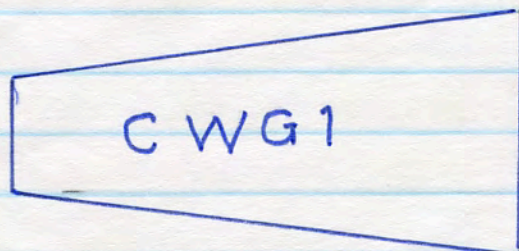

3788

No name 87 OV B dark brown T. C.
6 lbs. $5\frac{1}{8}" \times 5\frac{3}{8}" \times 2\frac{1}{2}"$
no panels. letters stamped on base.
Acpton Mori dem. site 26. 10. '88

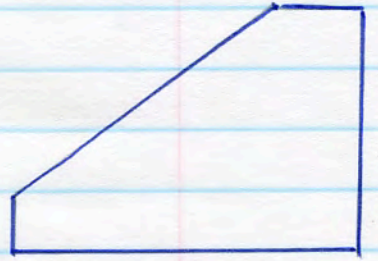

3789

No name 87 OV A dark brown T. C.
6 lbs $6\frac{3}{4}" \times 5\frac{3}{8}" \times 2\frac{1}{2}"$
no panels. letters stamped on base.
Acpton Mori dem. site. 26. 10. 88

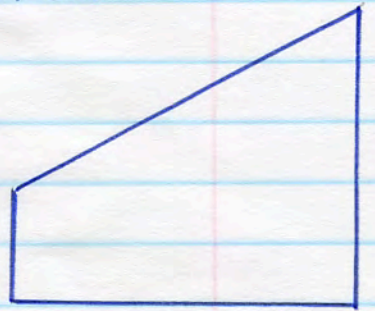

3790

No name 14 RSLI red T. C
9 lbs. $8\frac{1}{2}" \times 5\frac{1}{2}" \times 4"$
no panels. letters scribed on base.
Acpton Mori dem. site 26. 10. 88.

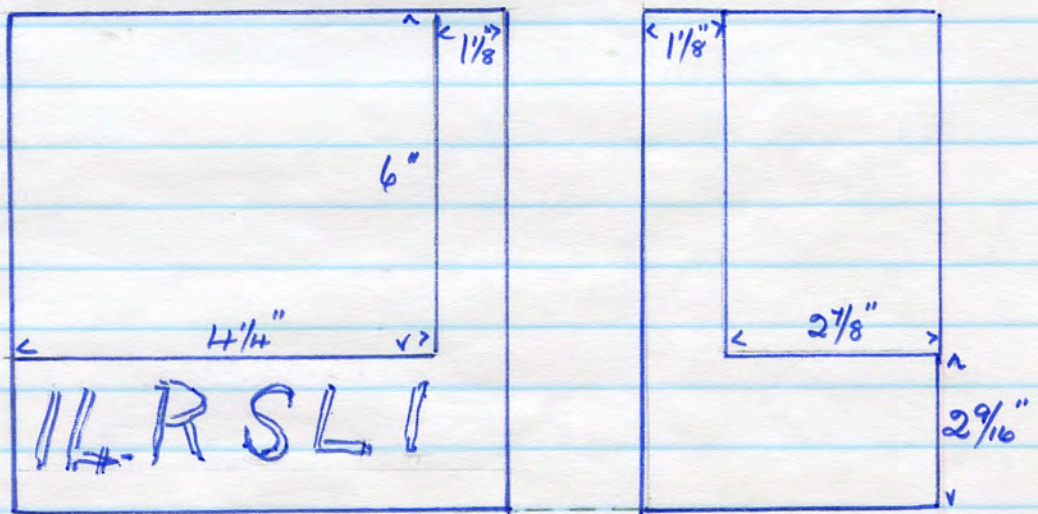

3791

No name POFN 5X red T. C. tile
7 lbs. $8\frac{1}{2}" \times 4" \times 2\frac{1}{2}"$
no panels. letters stamped on edge.
rockle shell effect on surface
small step $1\frac{1}{2}" \times 1\frac{1}{2}" \times \frac{7}{8}"$
Acpton Mori dem. site
26. 10. 88

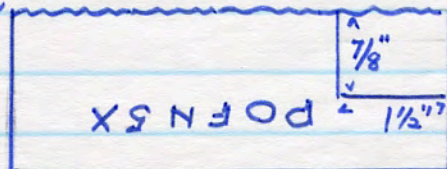

No name 284 T15 red T.C. double splay stretcher
12 lbs. $8\frac{7}{8}'' \times 6'' \times 2\frac{3}{4}''$

3792 no panels. numbers stamped 1 side
Acc/ton Nori dem. site 26. 10. 88.

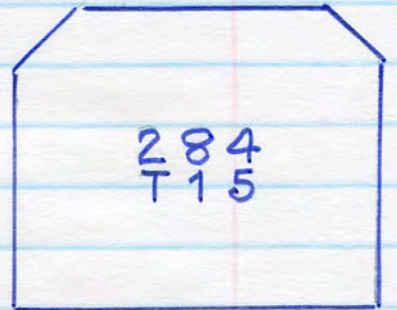

No name 314 TJ red T.C jamb splayed
11 1/2 lbs. $7\frac{3}{4}'' \times 7\frac{3}{4}'' \times 2\frac{3}{4}''$

3793 no panels. letters stamped 1 side.
1 perf $1\frac{7}{8}''$ diam. rebate $2'' \times \frac{3}{4}''$
Acc/ton Nori dem. site
26. 10. 88

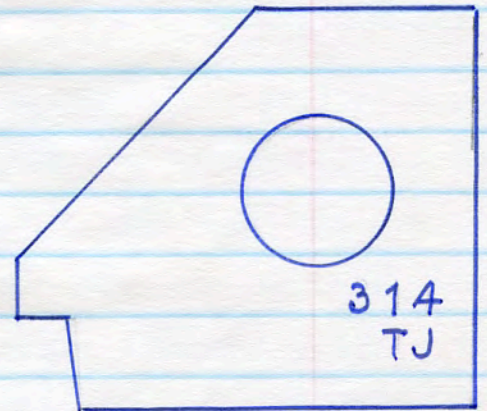

No name. 3-4 red T.C radial stretcher.
9 lbs. $8\frac{1}{2}'' - 7\frac{3}{4}'' \times 4\frac{1}{8}'' \times 2\frac{3}{4}''$

3794 no panels, stamped 3-4 on one end
Acc/ton Nori dem. site 25. 10. 88.



No name L (on square end) red T.C squint
6 lbs $8'' \times 4'' \times 2\frac{1}{2}''$

3795 no panels
1 cavity $5\frac{1}{4}'' \times 1\frac{1}{2}'' \times 1\frac{3}{4}''$ deep.
rustic finish 1 edge cont'd to point
Acc/ton Nori dem. site 25. 10. 88.

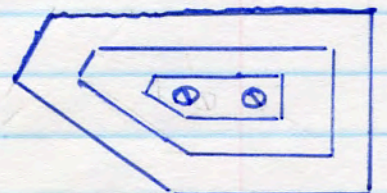

3796 No name. red T.C. dec header.
 5 lbs. $4\frac{1}{4}" \times 4\frac{1}{4}" \times 2\frac{5}{16}"$
 no panels. rebate $1\frac{1}{2}" \times 1"$
 Acpton Mori dem. site 25. 10. 88

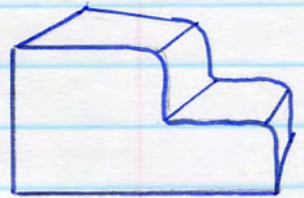

3797 No name KS red T.C.
 10 lbs $8\frac{5}{8}" \times 4\frac{1}{8}" \times$
 no panels. 1 stud hole, for fixing,
 in each end. stamped on 1 end.
 Acpton Mori dem. site 26. 10. 88

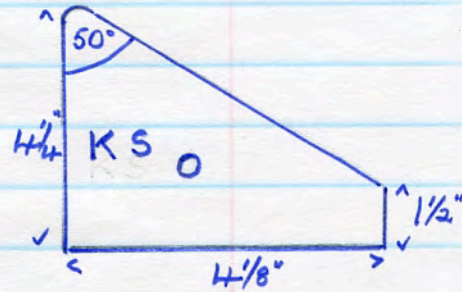

3798 No name P N 5 red T.C. Scotia
 12 lbs. $8\frac{1}{2}" \times 5" \times 5"$
 no panels. 1 stud hole, for fixing, $\frac{3}{8}"$ diam. in each end.
 letters stamped on 1 end.
 Acpton Mori dem. site
 26. 10. 88

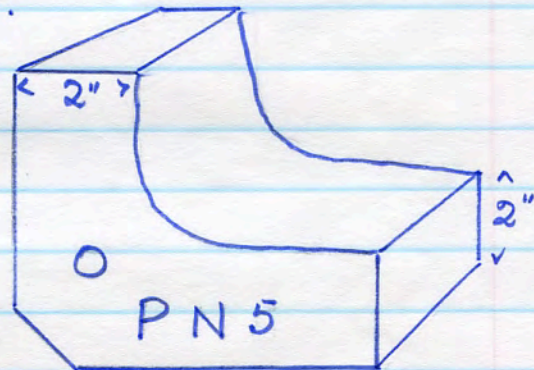

3799 No name P N X B R red T.C. Scotia. 1 end return
 13 lbs $8\frac{5}{8}" \times 4\frac{3}{4}" \times 5"$
 no panels. stamped on rev.

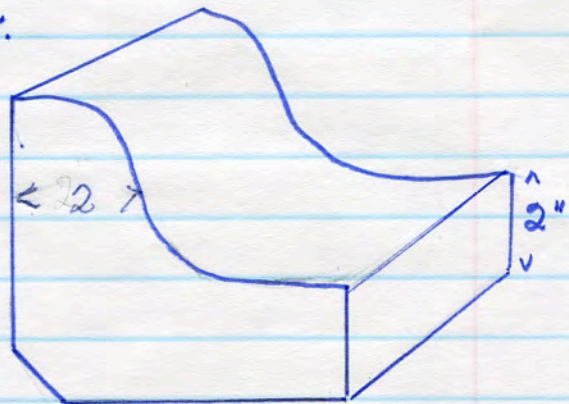

Acpton Mori dem. site
 26. 10. '88

No name. 23103 D dark brown T.C cap with
 19 lbs $8\frac{3}{8}'' \times 8\frac{3}{8}'' \times 3\frac{3}{4}''$ $\frac{1}{4}$ round return 2 sides
 * 2 perfs 1" diam.

3800

large $5'' \times 5\frac{1}{2}'' \times 2''$ cavity.
 no final finish to piece, scrape marks still show
 Acpton Mori dem. site 26. 10. 88.

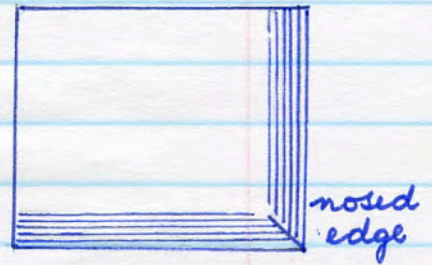
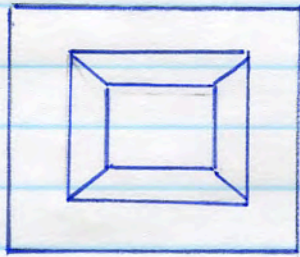

No name PP red T.C tile, bull nose each end.
 7 lbs $8\frac{5}{8}'' \times 4'' \times 2''$

3801

no panels. letters stamped on end
 Acpton Mori dem. site 26. 10. 88

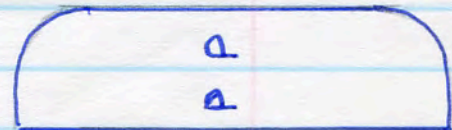

No name red T.C.
 $3\frac{1}{2}$ lbs. $8\frac{3}{8}'' \times 2\frac{1}{2}'' \times 1\frac{3}{4}''$

3802

3 grooves in base $1\frac{3}{8}''$ diam.
 Acpton Mori dem. site 26. 10. 88.



No name. 253 T2 red T.C. chamfered block $\cdot 2''$
 3 lbs. $4'' \times 4'' \times 2\frac{1}{2}''$

3803

no panels. numbers stamped on side
 Acpton Mori dem. site. 26. 10. 88.

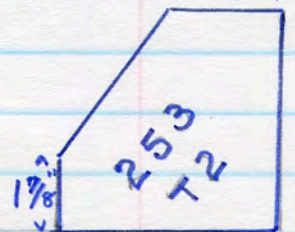

No name. 2362 D dark brown T.C quadrant moulded
 7 lbs. $8\frac{1}{4}'' \times 4'' \times 2\frac{3}{8}''$ stretchers.

3804

no panels. numbers stamped on end
 Acpton Mori dem. site.
 26. 10. 88.

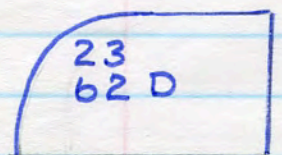

No name. PG 3 N red T.C. bull nosed floor tile
6 1/2 lbs. 8 3/8" x 4" x 1 3/4"

3805

no panels. letters stamped in base
cockle shell effect on surface but
not on bull nose.

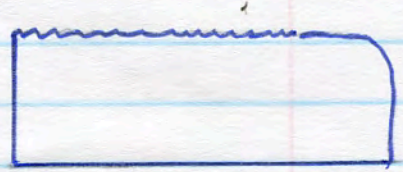

Acc/ton Mori dem. site 26. 10. '88

No name. 12 red T.C. triangular block.

2 lbs 3 7/8" x 3 7/8" x 2 3/4"

3806

no panels. stamped 1 end
all edges pencil moulded.

Acc/ton Mori dem. site 26. 10. '88

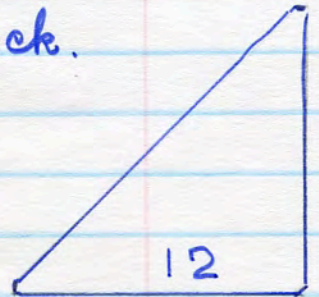

No name. 87 M 405 red T.C. triangular block.

3 lbs. 5 3/8" x 4" x 2 3/4"

3807

no panels. stamped 1 end
all arrises pencil moulded.

Acc/ton Mori dem. site 26. 10. '88

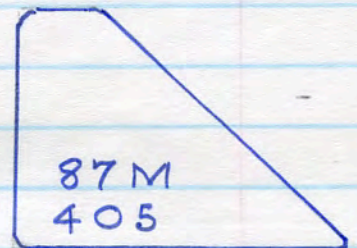

No name. 450 400 red T.C. triangular block

3 lbs 5 1/2" x 2 3/4" x 2 7/8"

3808

no panels. stamped on end.

arrises pencil moulded.

Acc/ton Mori dem. site 26. 10. '88

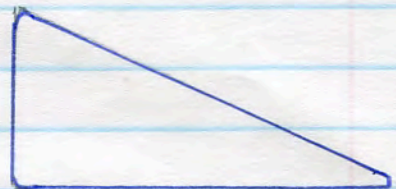

No name. 450 501 red T.C. triangular block

3 lbs. 5 1/4" x 4" x 2 7/8"

3809

no panels. stamped 1 end.

arrises pencil moulded

Acc/ton Mori dem. site

26. 10. '88

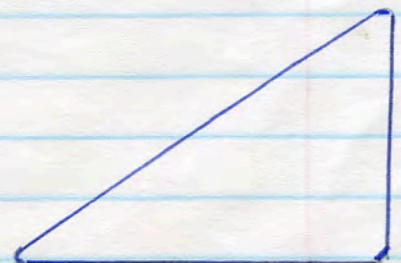

3810 No name red T.C. circular
4 lbs. 4" long, 4⁵/₈" diam. 3/4" thick
Acc/ton Nori dem. site 26. 10. '88

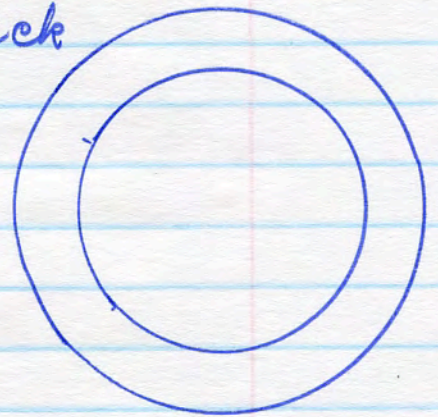

3811 No name. 23172 red T.C double moulded jamb.
.7 lbs

single panel obj. only
letters scribed in panel
plain rev.

Acc/ton Nori dem site
26. 10. '88

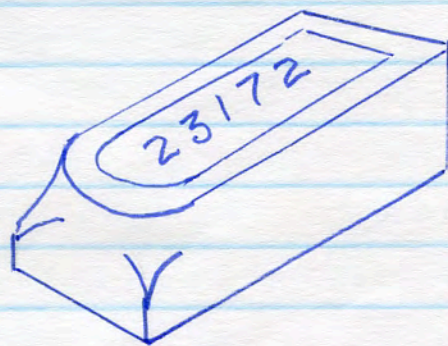

3812 No name 959 VC red T.C L shaped support.
5 lbs 8¹/₂" x 2³/₄" x 4"
no panels, stamped 1 side
Acc/ton Nori dem. site 27. 10. '88

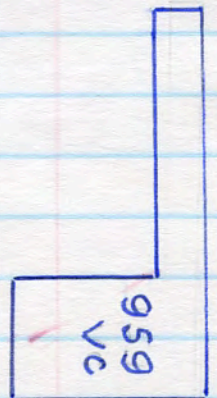

3813 No name. 1PB red T.C internal angle.
6 lbs. 6" x 3¹/₄" x 3¹/₄"
no panels, scribed for fixing.
Acc/ton Nori dem. site 26. 10. '88

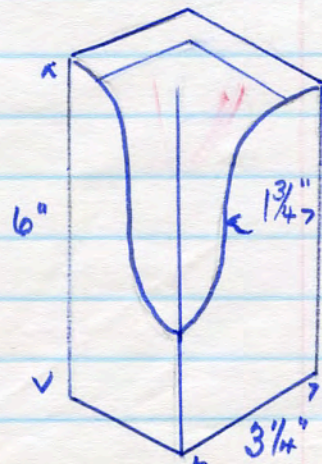

No name 50 WBR red T.C internal angle
6 lbs
no panels. scribed letters

3814

Asclon Moni dem. site
26. 10. '88

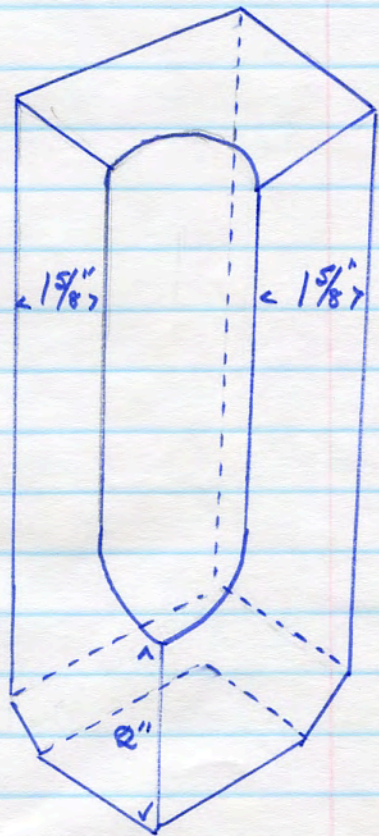

3815

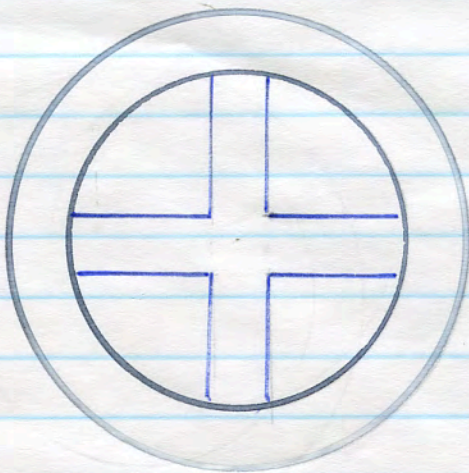

No name
red T.C circular divider with
vertical + horizontal supports
4" long 4" diam. over all
sides 3/8" thick. 2 lbs.

Asclon Moni dem. site 28. 10. '88

No name 23151 red T.C return end wall cap.
 14 lbs $8\frac{3}{8}" \times 6\frac{1}{8}" \times 3\frac{7}{8}"$
 large cavity $5\frac{1}{2}" \times 2\frac{3}{8}" \times 1\frac{1}{4}"$ deep

3816

1 perf 1" diam in side
 letters stamped on 1 side

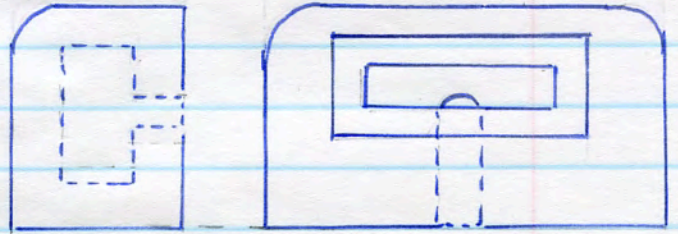

3817

No name 2A EXTL red T.C splayed wall cap with
 11 lbs $8\frac{5}{8}" \times 5\frac{1}{8}" \times 2\frac{7}{8}"$ return end & moulded water drip
 small panel in 1 end
 letters scribed

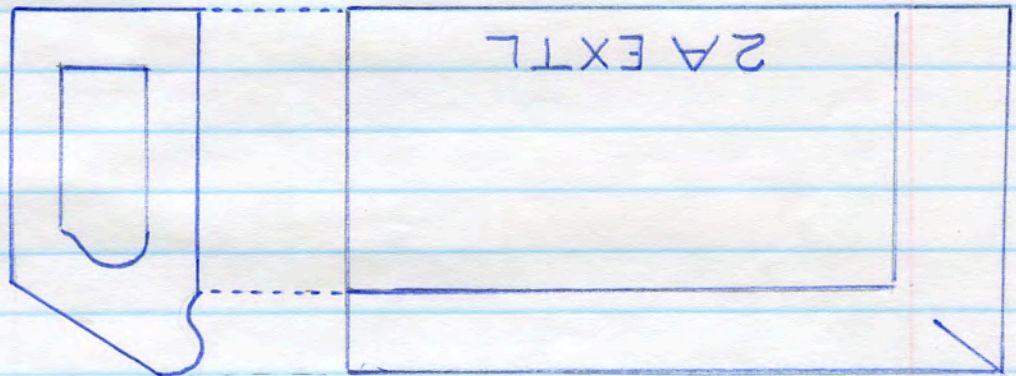

No name PNGA red T.C corner piece with base.
 4 lbs $5" \times 5" \times 1\frac{7}{8}"$ base $4\frac{7}{8}"$ height over all (in corner)
 no panels. letters scribed 1 side

3818

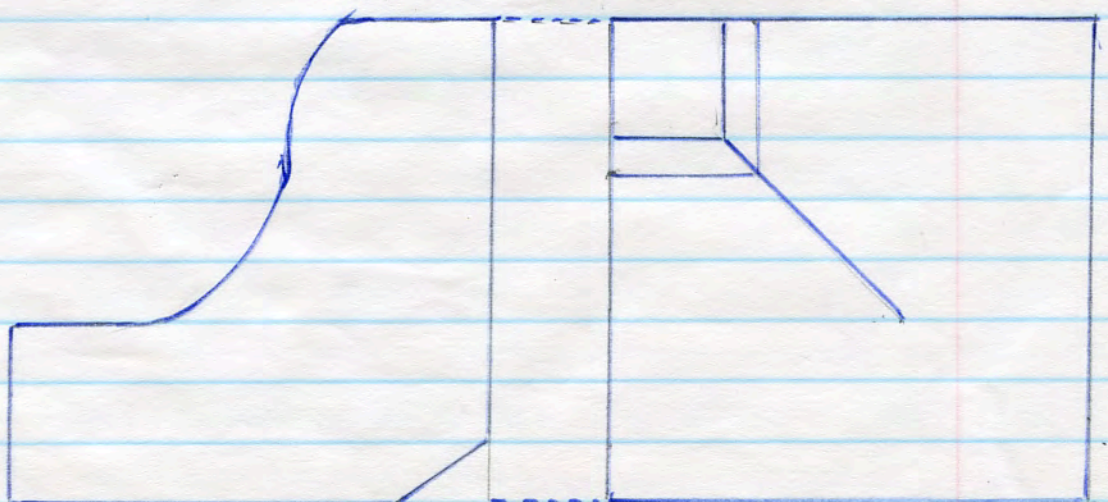

3819

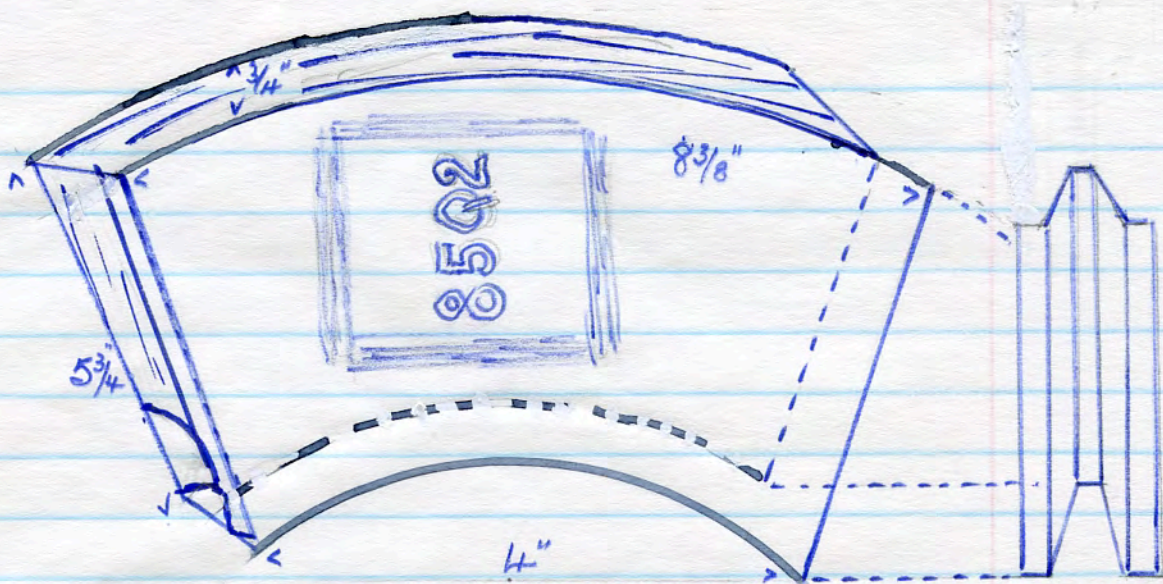

No name 85Q2 T&G quadrant, red T.C.
 6 lbs numbers scribed. drawn from a radius of 40"
 Acc/ton Mori dem. site 26. 10. '88

3820

No name HB 37 NI red T.C circular lid
 11 lbs top 8 3/4" diam. base 8 1/2" diam 3/4" thick

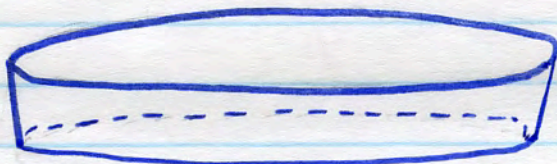

Acc/ton Mori dem. site. 29. 10. '88

No name 89Q20 red T.C
 4 lbs 10" x 3" x 2"
 numbers scribed. Acc/ton Mori dem. Site 29. 10. 88

3821

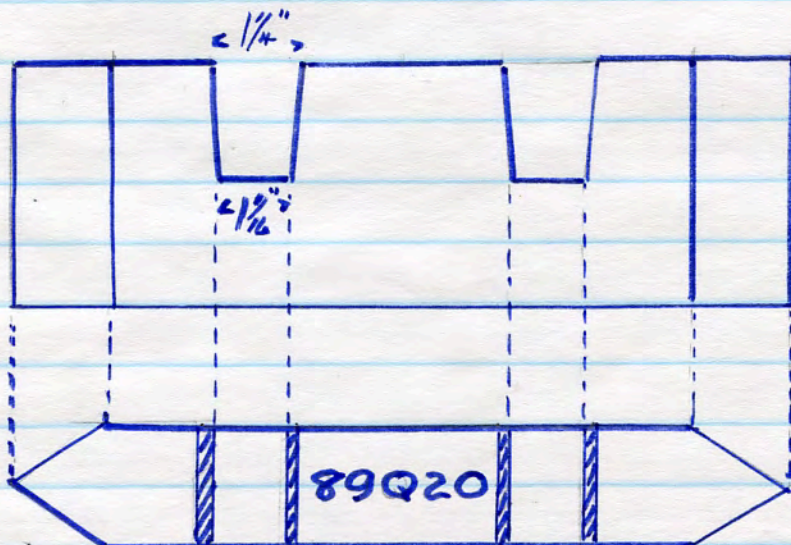

No name 668 YR red T.C tile with return
6 lbs $8\frac{1}{4}'' \times 4'' \times 2''$

3822

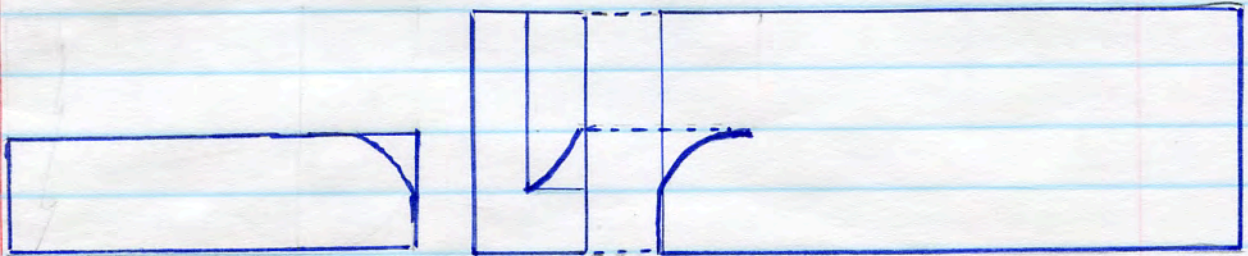

Acc/Kon Mori dem. site 29. 10. 88

No name red T.C.
5 1/2 lbs. $9'' \times 4\frac{3}{4}'' \times 1\frac{1}{2}''$
dove tailed groove along 1 side $1\frac{3}{8}''$ wide.

3823

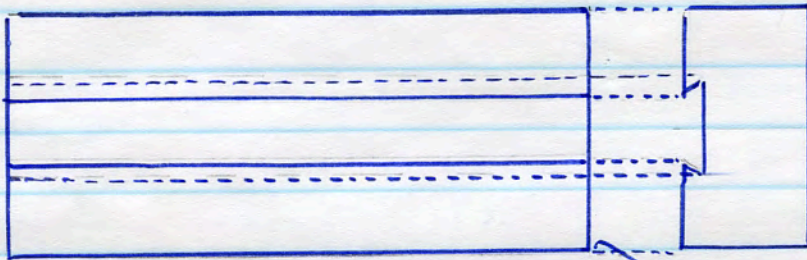

Acc/Kon Mori dem. site 29. 10. 88.

No name. red T.C vertical segment. 27091 wide.
6 lbs $8\frac{1}{4}''$ sloping to $7\frac{7}{8}''$ height. $1\frac{5}{16}''$ thick. $5\frac{3}{8}'' - 5\frac{9}{16}''$

3824

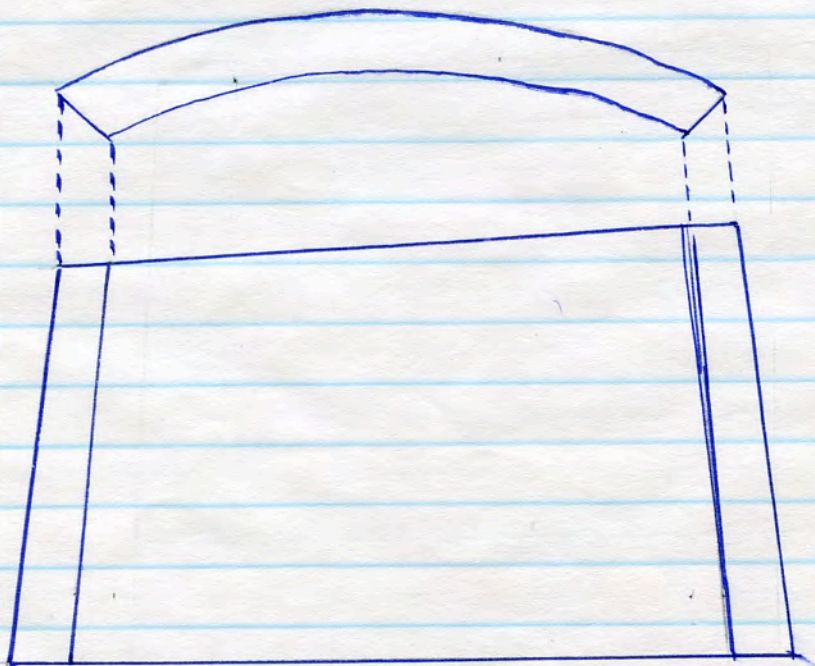

Acc/Kon Mori dem. site 29. 10. '88

3825

No name 245 TD red T.C

2 lbs. 4" x 4" x 1 3/4" - 1 3/8"

no panels. letters stamped 1 side

Acc/lon Mori dem. site 30. 10. '88



No name. 145 \ U red T.C

5 lbs. 7" x 5" x 1 1/2" (base).

no panels. numbers scribed

letters stamped.

3826

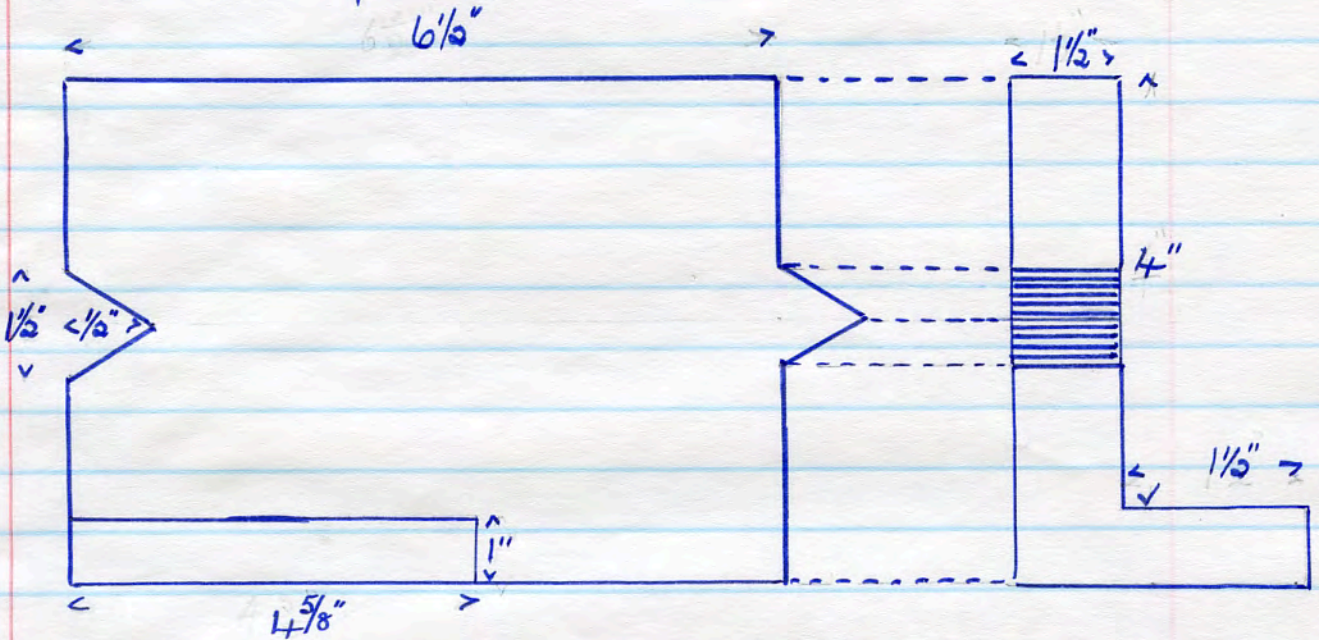

Acc/lon Mori dem. site 30. 10. '88

3827

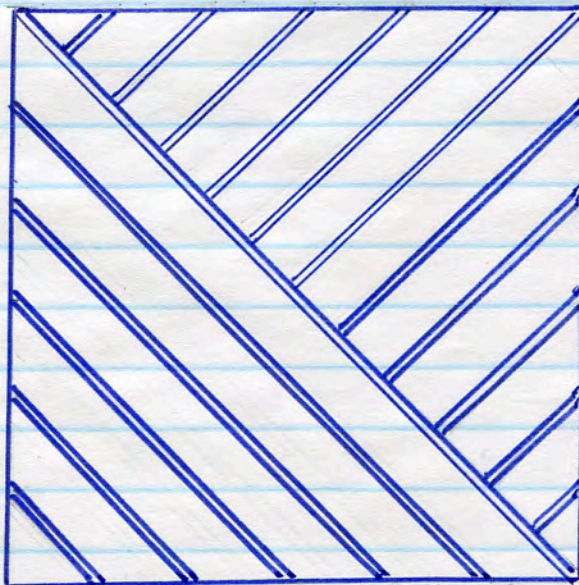

red T.C des. tile

5 lbs 6 1/2" x 6 1/2" x 1 3/8"

Produced by Enfield

Brick & Terra cotta Co Ltd

who were taken over by

Acc/lon Brick & Tile Co.

Acc/lon Mori dem. site

27. 10. '88

ENFIELD stamped on 1 side

No name 45 90 red T.C.

7 lbs.

6" x 6" two way splitter head into a circular exit 3" diam. 3/4" thick.

3828

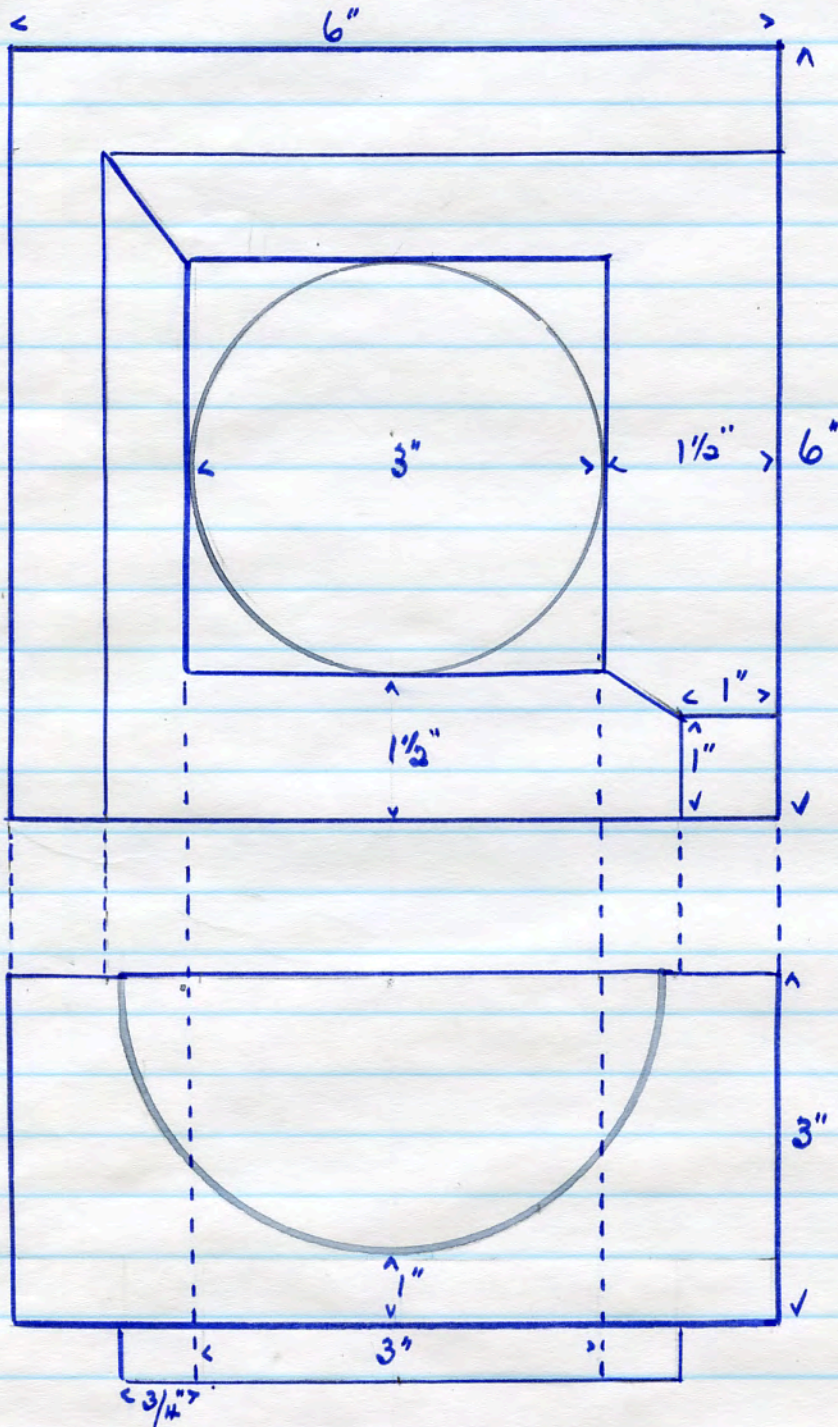

letter & numbers scribed on 1 side

Acc/ton Nori dem. site. 27. 10. '88

3829

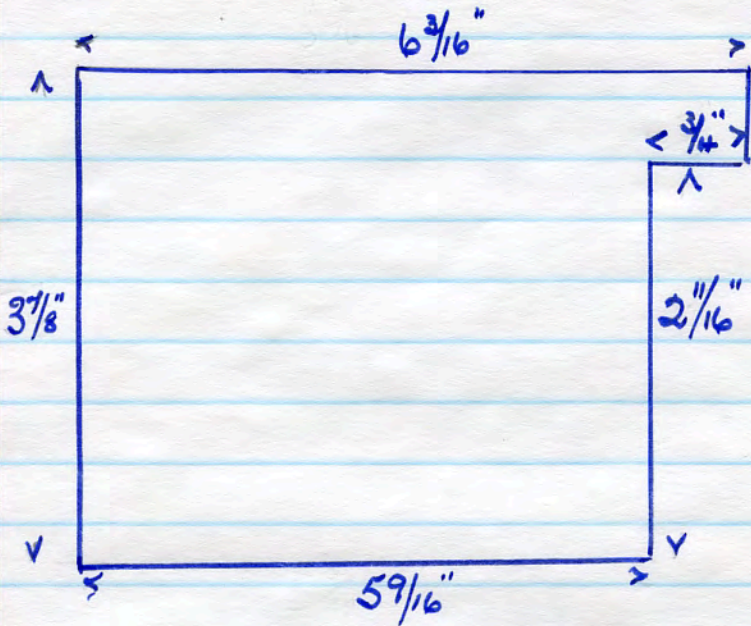

No name. 285T2
 red T.C.
 no panels.
 letters stamped 1 side
 5 lbs.

Acception Mori dem. site
 31. 10. '88

No name 248 T 85 red T.C. gauged brk for flat arch

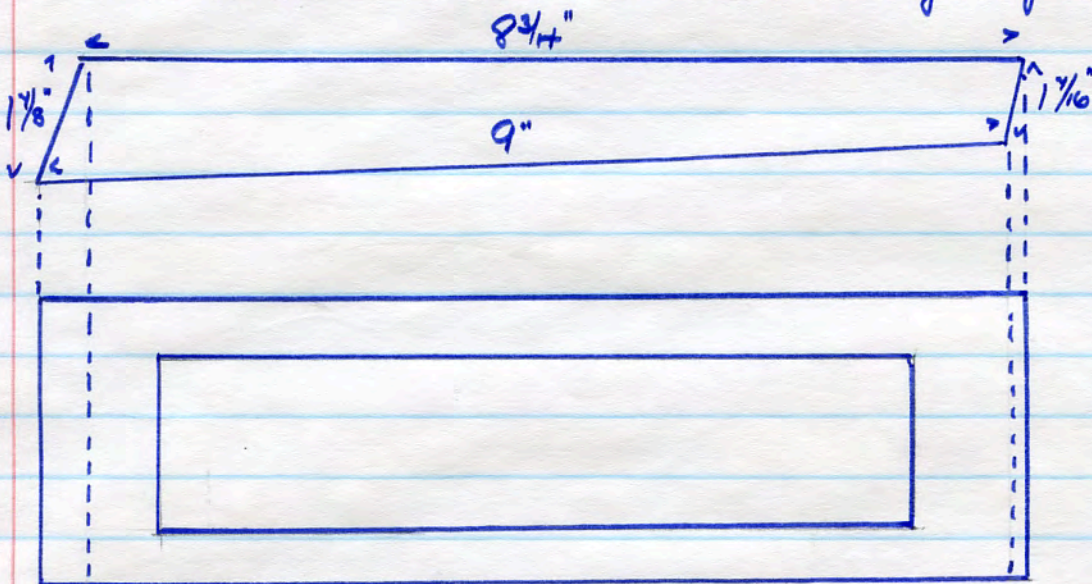

3830

5 lbs. single panel each side. letters stamped on 1 7/8" end.

Acception Mori dem. site 31. 10. '88

3831

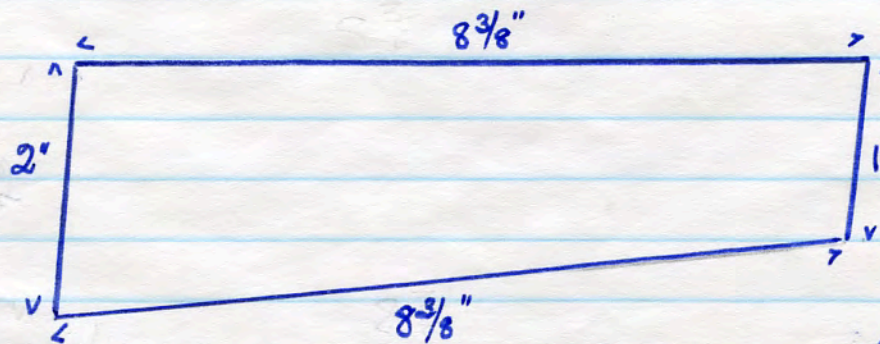

No name
 248 T 81

red T.C.

6 lbs

single panel each side as 3830

gauged brk for flat arch. Acception dem. site 31. 10. '88

3832

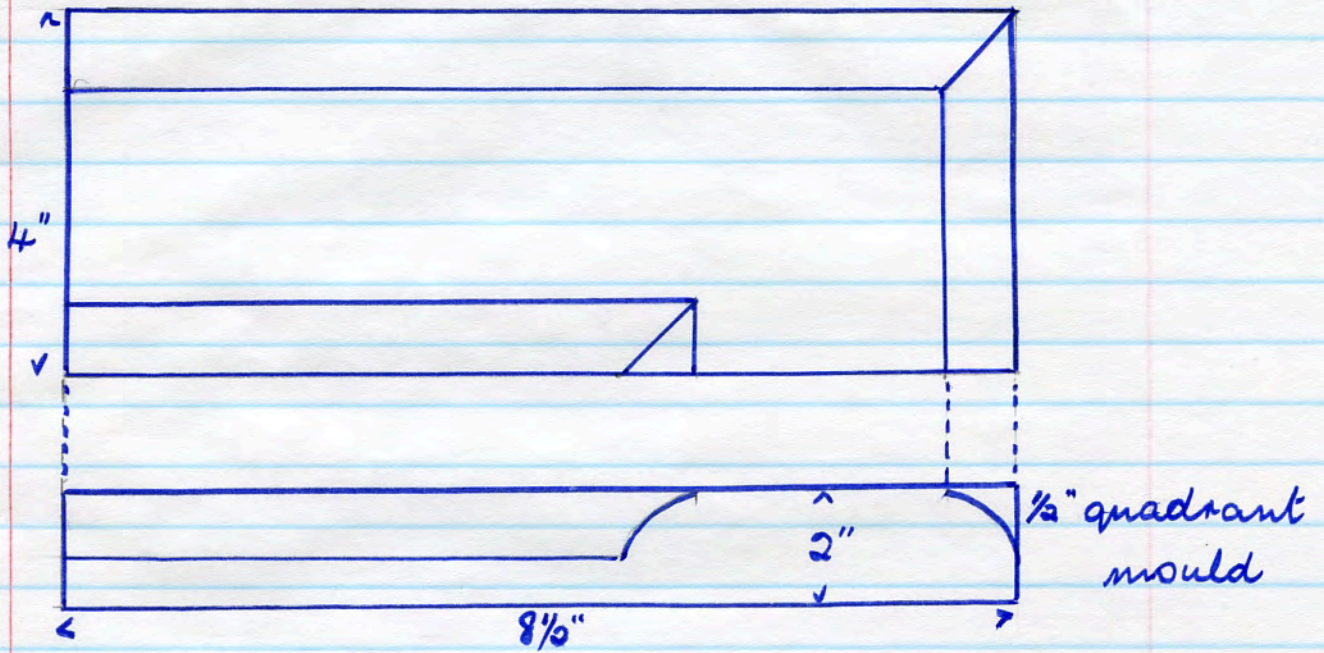

No name. P 2 X L red T.C tile edging 4 return
 6 lbs no panels left hand to
 Acc/ten Mori dem. site 31. 10. '88. 3926

3833

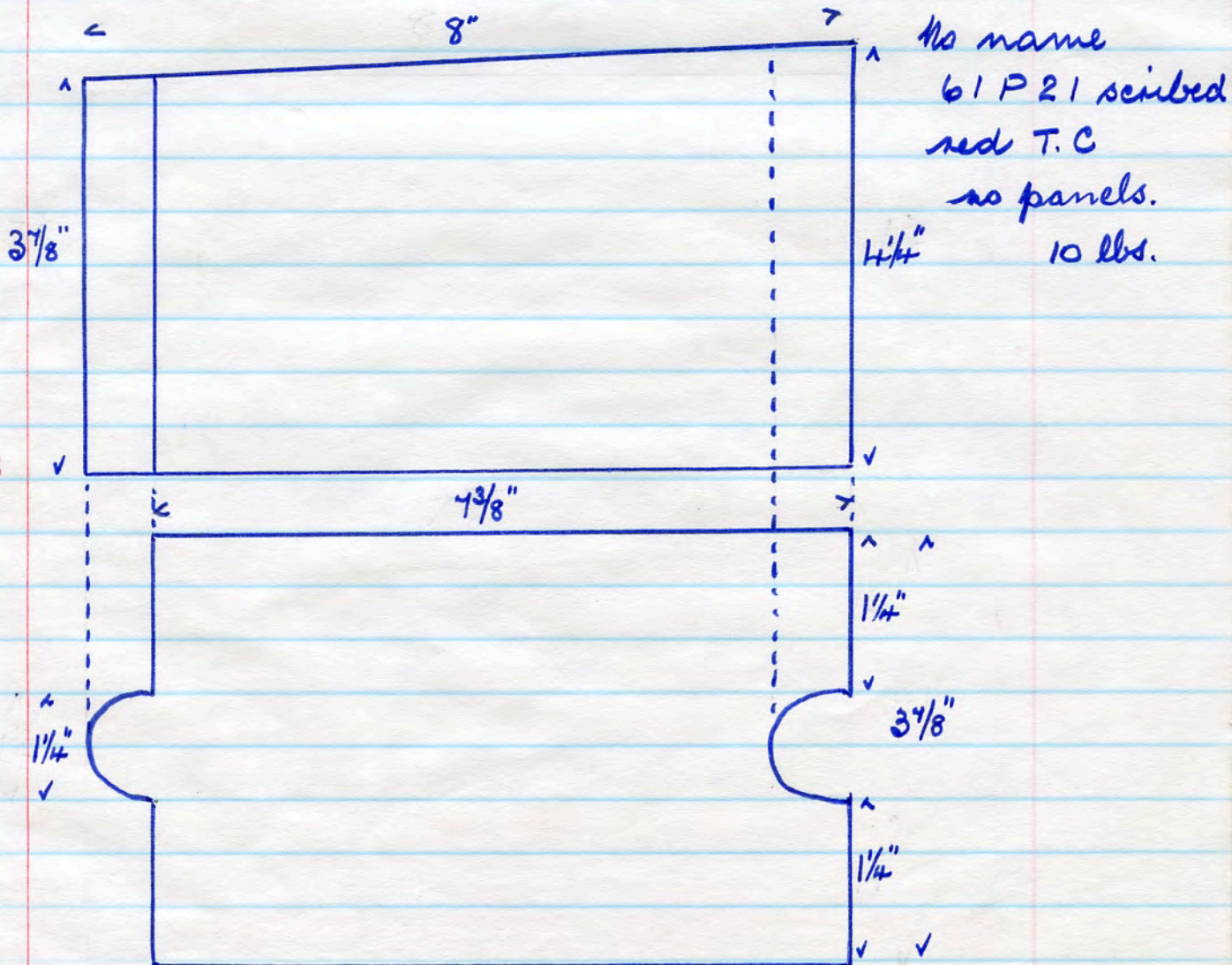

No name
 61 P 21 scribed
 red T.C
 no panels.
 10 lbs.

No name. 236 T. dark brown T.C. internal rt) wall
 6 lbs. numbers stamped on 1 side
 6 stud holes for fixing
 Acc/ton Mori dem. site 29. 10. '88

3834

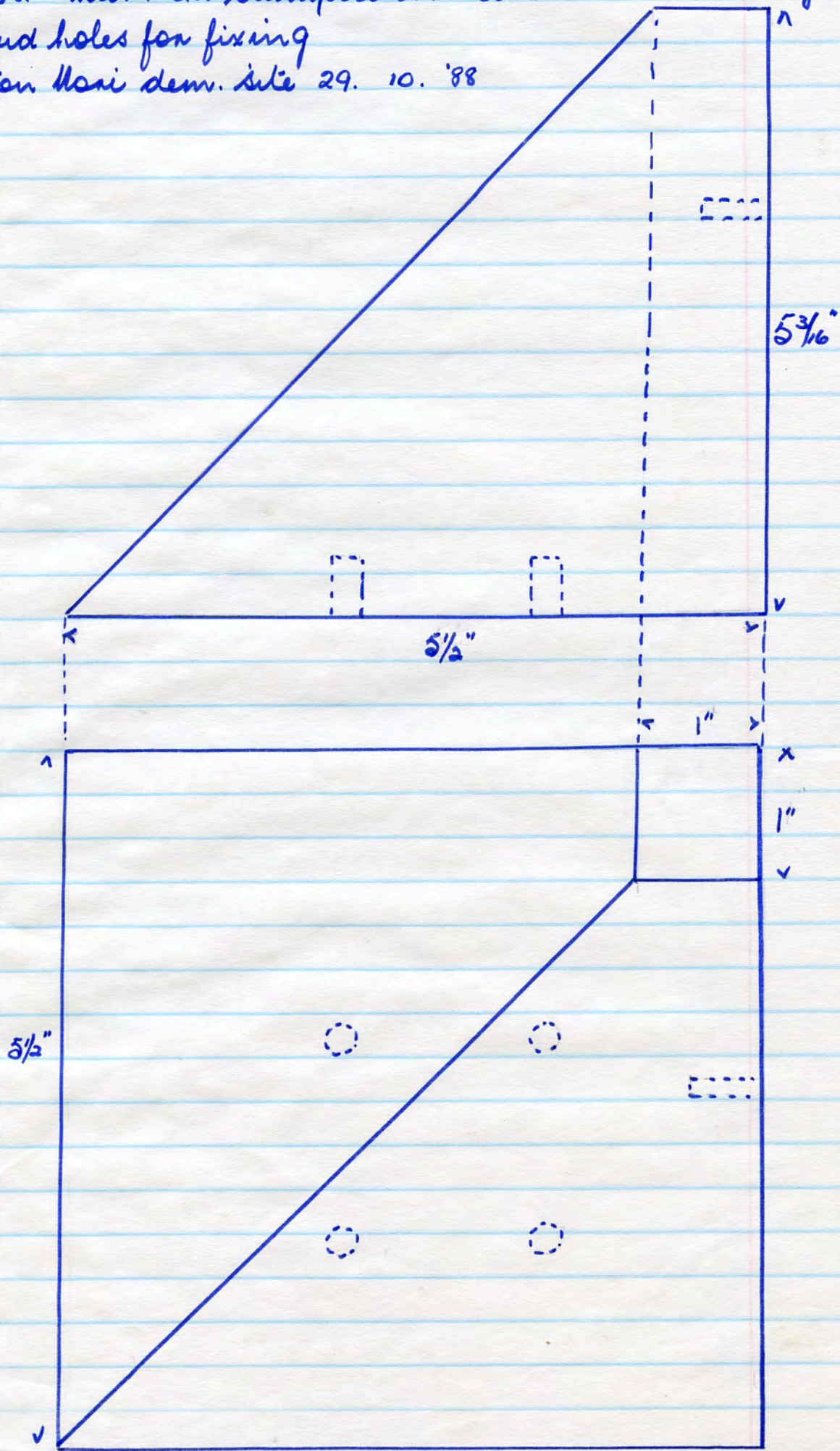

No name 145 2SB red T.C. rough sand faced
 7 lbs. numbers stamped. $5\frac{3}{4}$ "

3 stud holes
 for fixing

3835

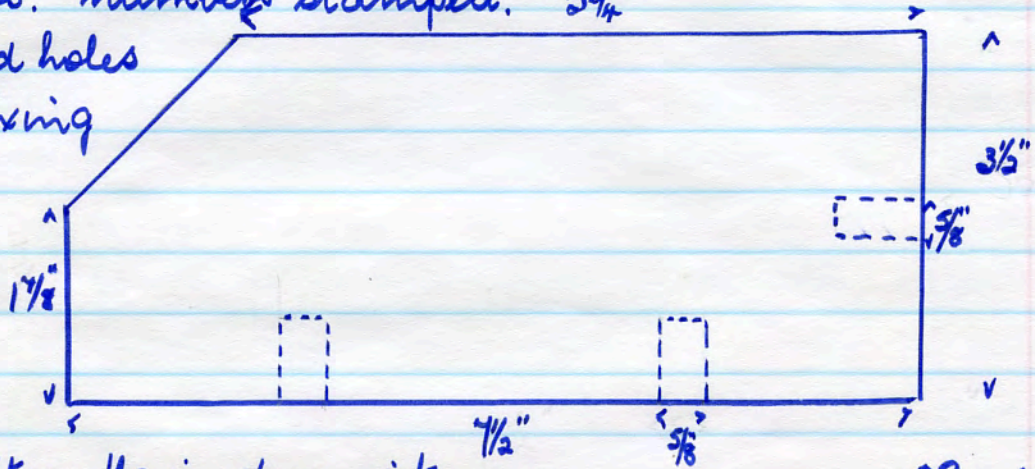

Acc/ton Hori dem site.

29. 10. '88

No name 25. 32B

7 lbs. length $8\frac{5}{8}$ "

3836

red T.C rough
 sand faced.

Acc/ton Hori

dem. site 29. 10. 88.

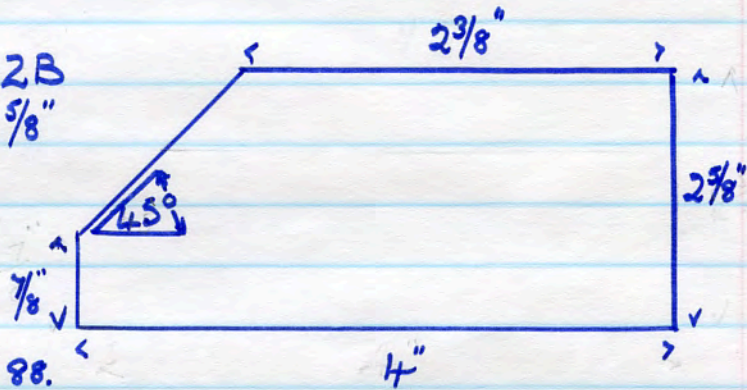

No name 4N 880 red T.C

10 lbs

$8\frac{5}{8}$ " x $4\frac{1}{8}$ " x $3\frac{1}{2}$ "

3837

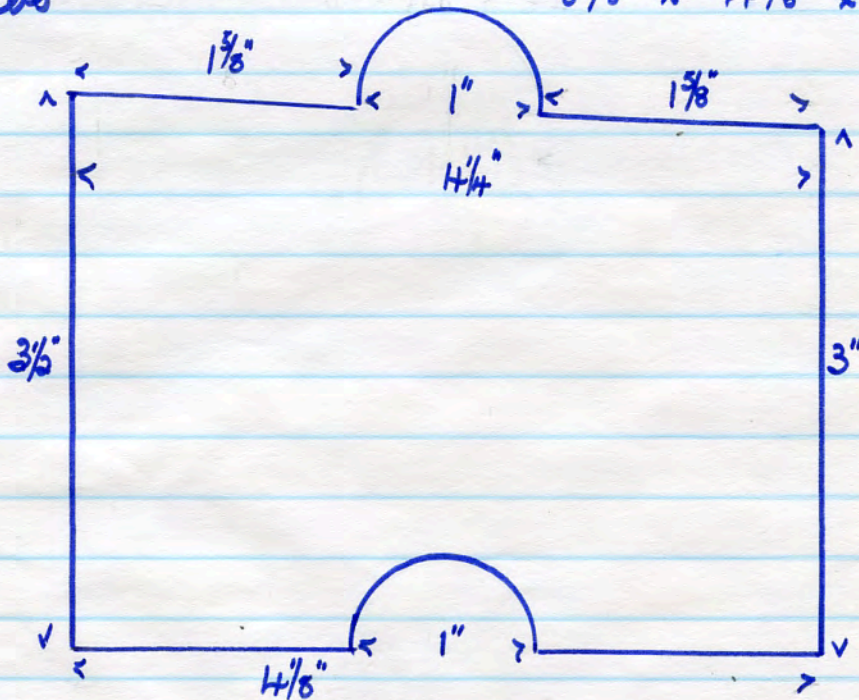

numbers stamped on the grooved face
 Acc/ton Hori dem. site 29. 10. 88

No name 61P20 J1 red T.C.
 7 lbs. 8" overall length x $3\frac{7}{8}$ " x 4"
 numbers scribed on 1 side.

3838

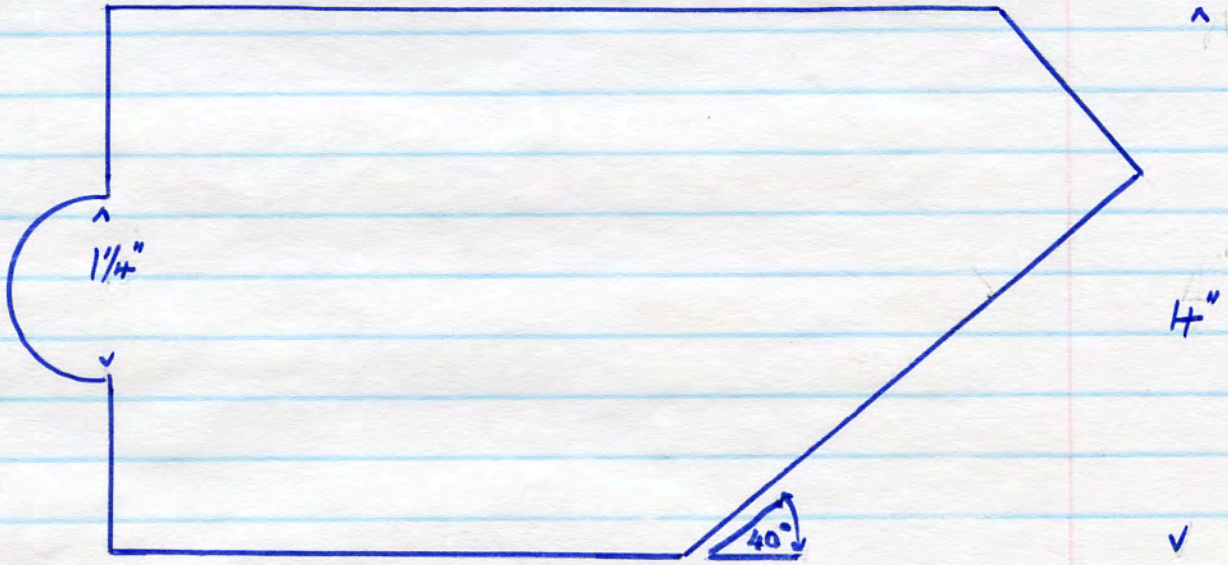

No name. 9 FBB red T.C.
 1 lb. 4" x 4" x 3"
 letters stamped on 1 side
 Accepton Nori dem. site
 29. 10. 88

3839

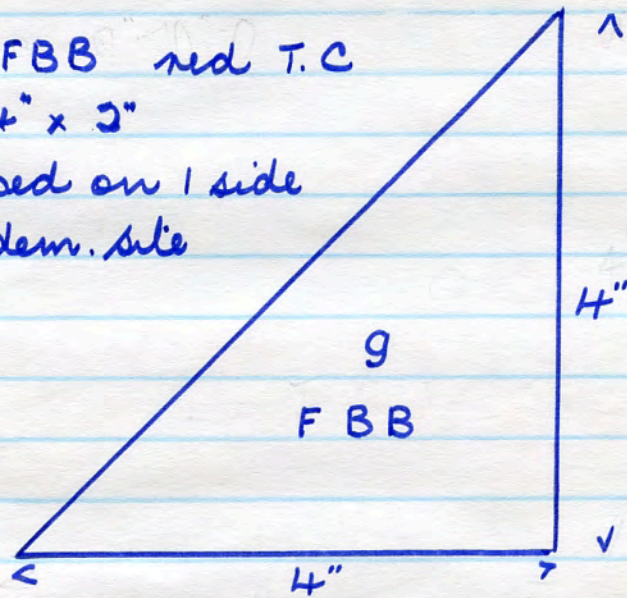

No name 734 VI red T.C.

3840

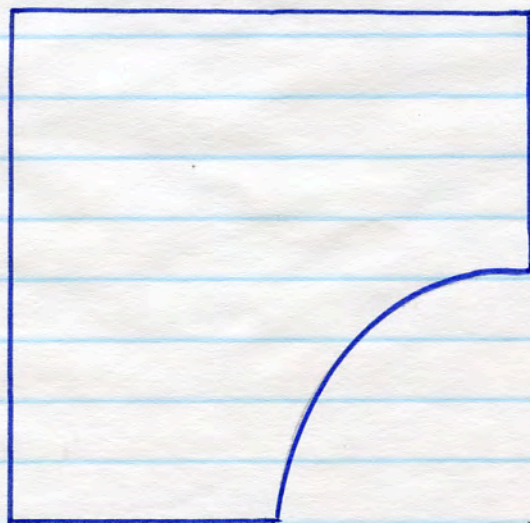

2 lbs. $5\frac{7}{8}$ " x $5\frac{7}{8}$ " x $1\frac{3}{8}$ "
 numbers stamped

Accepton Nori dem. site
 29. 10. 88

No name 23112RD dark brown T.C.

3841

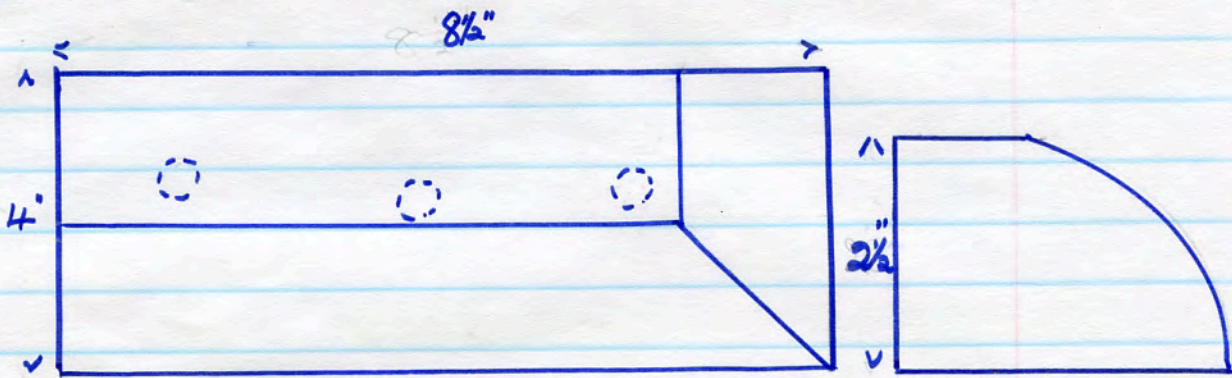

6 lbs. 3 stud holes for fixing. $8\frac{1}{2}$ " x 4 " x $2\frac{1}{2}$ "
Acc/ton Mori dem. site 29.10.88

No name OZC red T.C

actual size

2 lbs. $8\frac{1}{4}$ " x $3\frac{1}{4}$ " x $1\frac{3}{8}$ "

letters scribed on rev.

3842

Acc/ton Mori dem. site 29.10.'88

actual size

No name OZ red T.C.

5 lbs. $8\frac{1}{4}$ " x 6 " x $1\frac{3}{8}$ "

letters stamped on rev.

3843.

Acc/ton Mori dem. site 29.10.'88

No name. 044 VDD red T.C. floor tile
1 lb. $7\frac{7}{8}" \times 2\frac{1}{2}" \times 1\frac{3}{16}"$

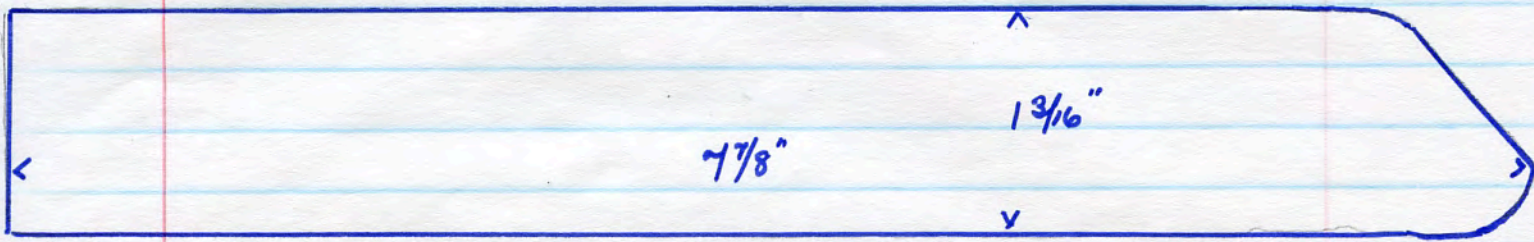

3844 letters stamped on rev.
Accton Mori dem. site. 30. 10. '88

No name 634 W12 red T.C.
3 lbs $8\frac{1}{4}" \times 3" \times 2"$

3845



letters stamped 1 side
Accton Mori dem. site 30. 10. '88

No name. PNGA red T.C external angle skirting
5 lbs. $5" \times 5" \times 2"$ base. 5" height overall.

numbers scribed on side.
Accton Mori dem. site
30. 10. '88.

3846

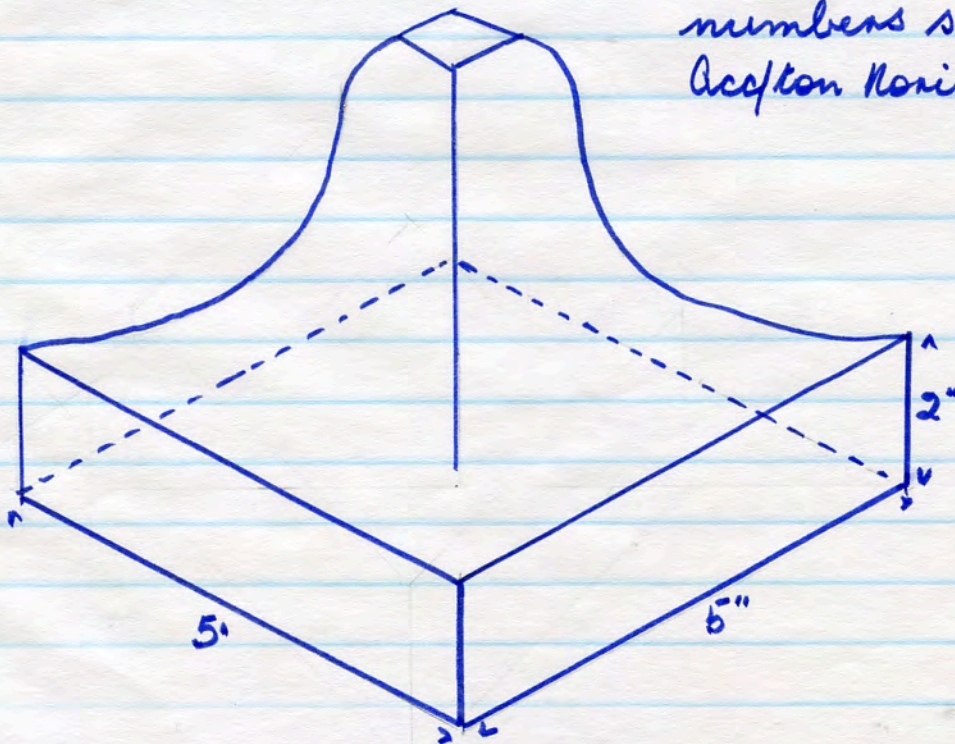

No name CWG1 red T.C.

2 lbs. $5\frac{3}{4}$ " x 3" tapering to $1\frac{3}{8}$ " x $2\frac{3}{16}$ "

Letters stamped on 1 side.

3847

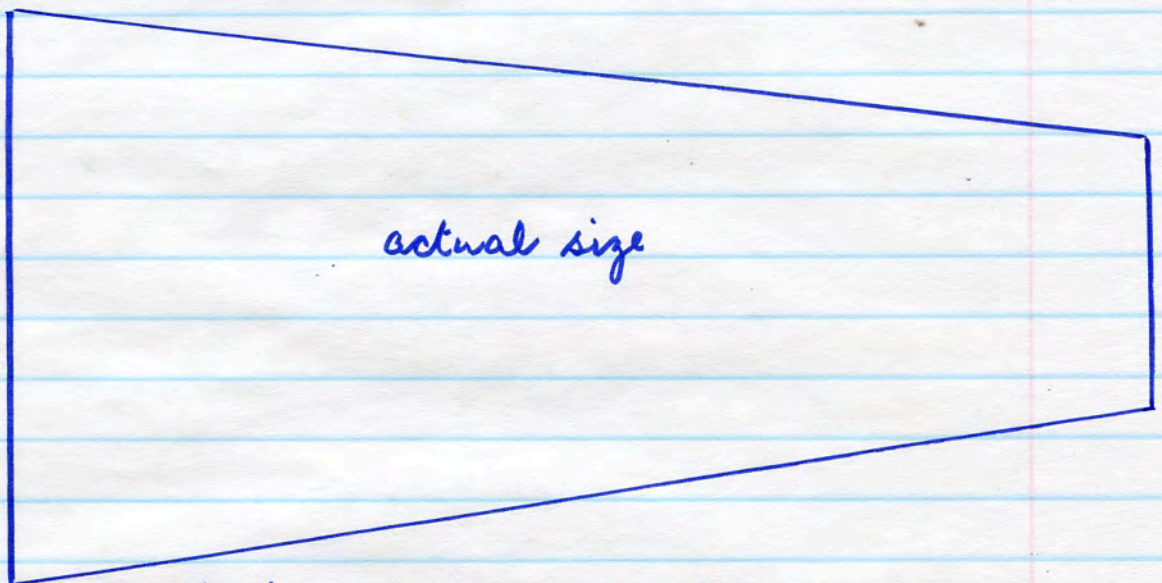

Acception Noni dem. site 30. 10. 88

No name.

red T.C. 3 way junction

5 lbs. 6" x 6" x 3"

1 straight side

Acception Noni dem. site 30. 10. 88.

3848

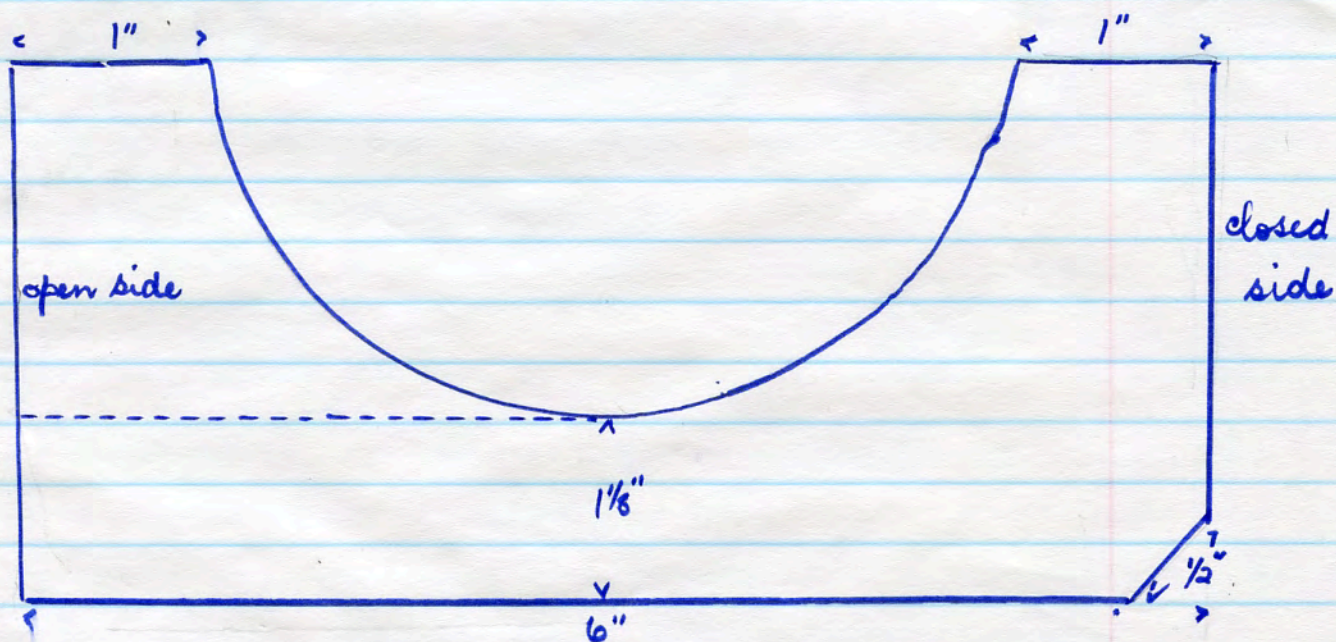

3849 No name. red T.C. $7\frac{3}{4}$ " numbers scribed 1 side 2 lbs.

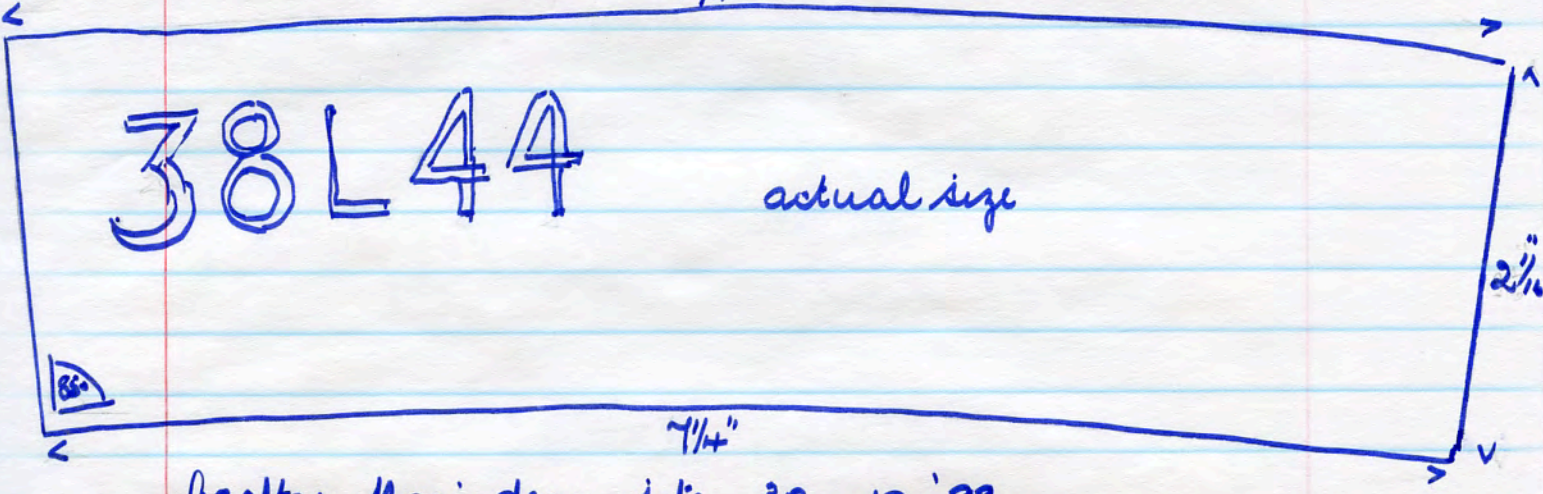

Acc/ton Mori dem. site 30. 10. '88.

No name. 38L 38. red T.C. 10 stud holes $\frac{3}{8}$ " diam. 29 lbs.

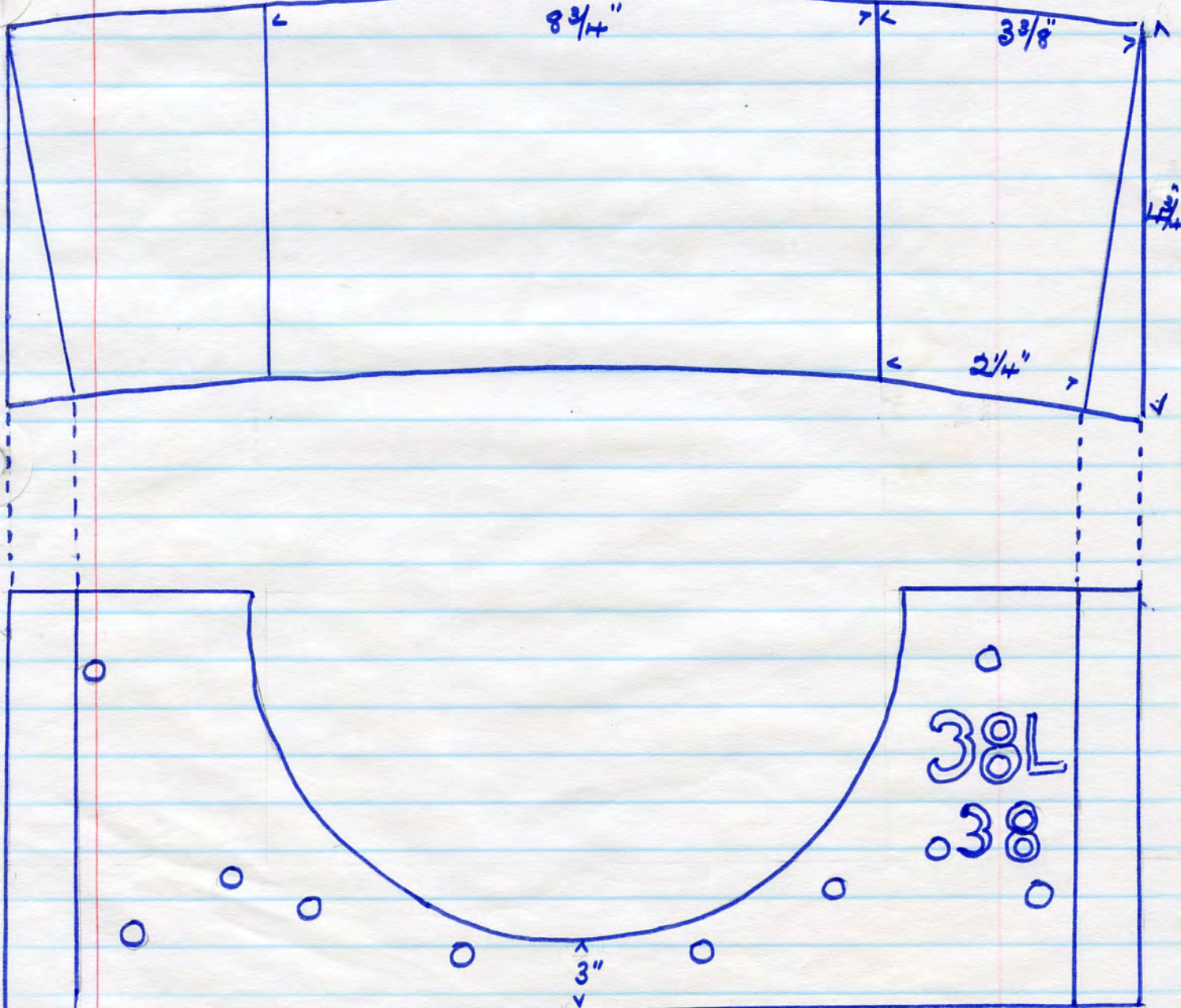

Acc/ton Mori dem. site 31. 10. 88.

3850

No name. red T.C. 12" 488 Y 2. 30 lbs. x
 Acc/ton Nori dem. site 30. 10. '88
 red T.C.

3851

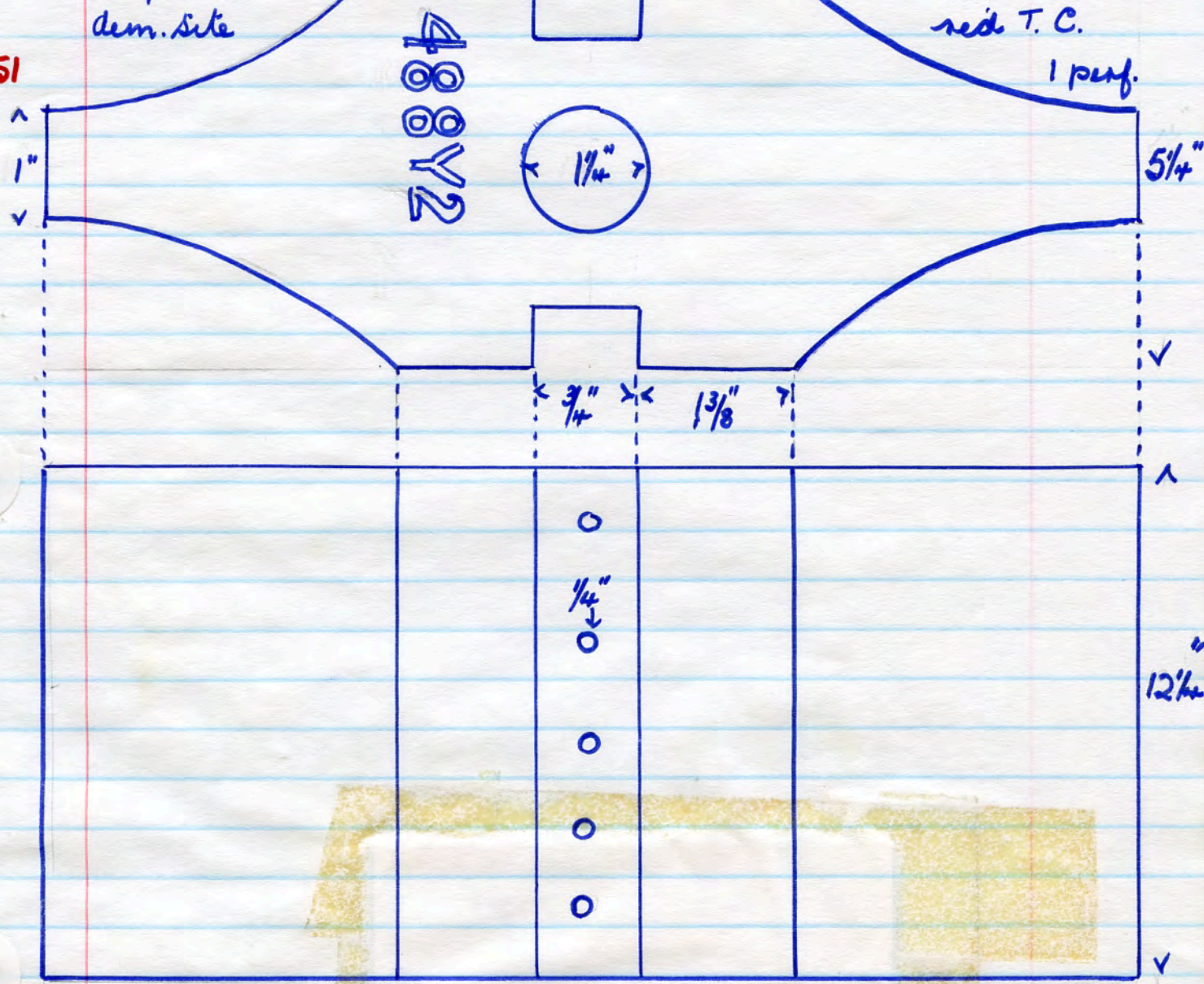

No name. 34 G 57 C
 letters stamped

3852

red T.C. 3 lbs.
 Acc/ton Nori dem. site
 30. 10. 88

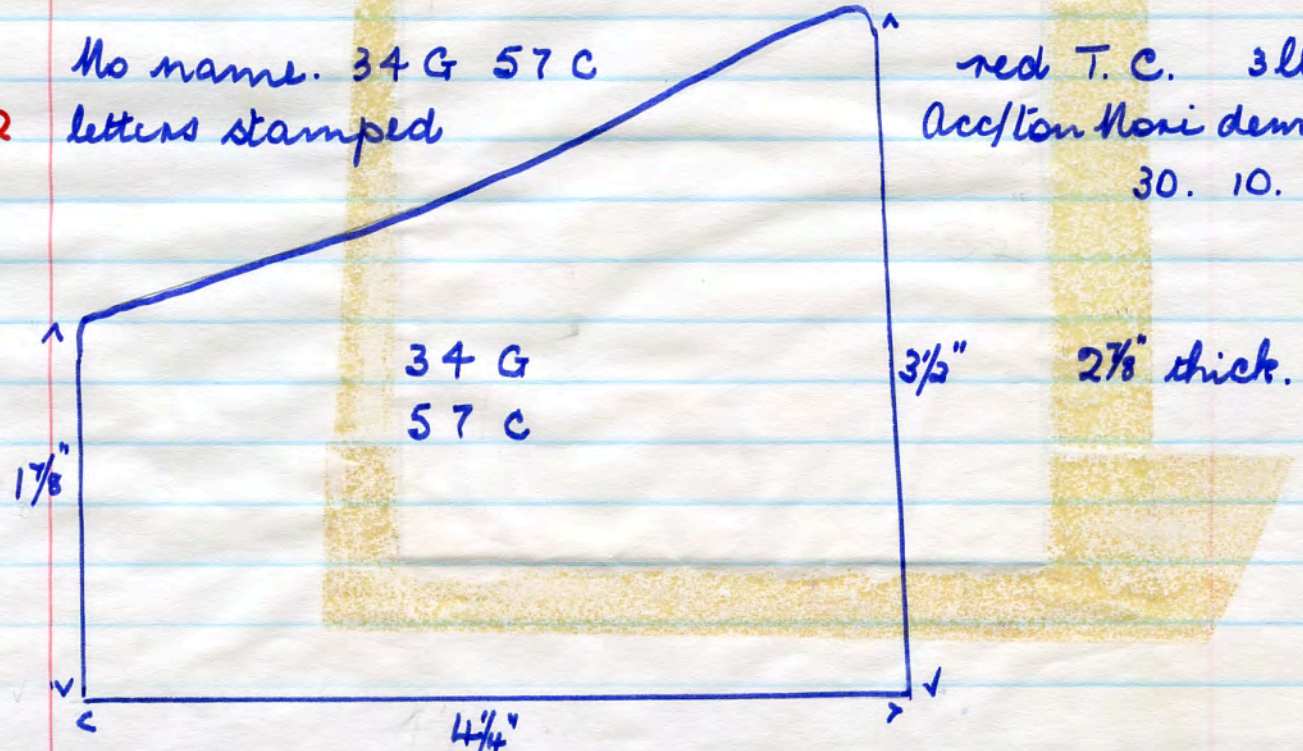

Handwritten text at the top of the page, including "SY884" and "D.T. 15°".

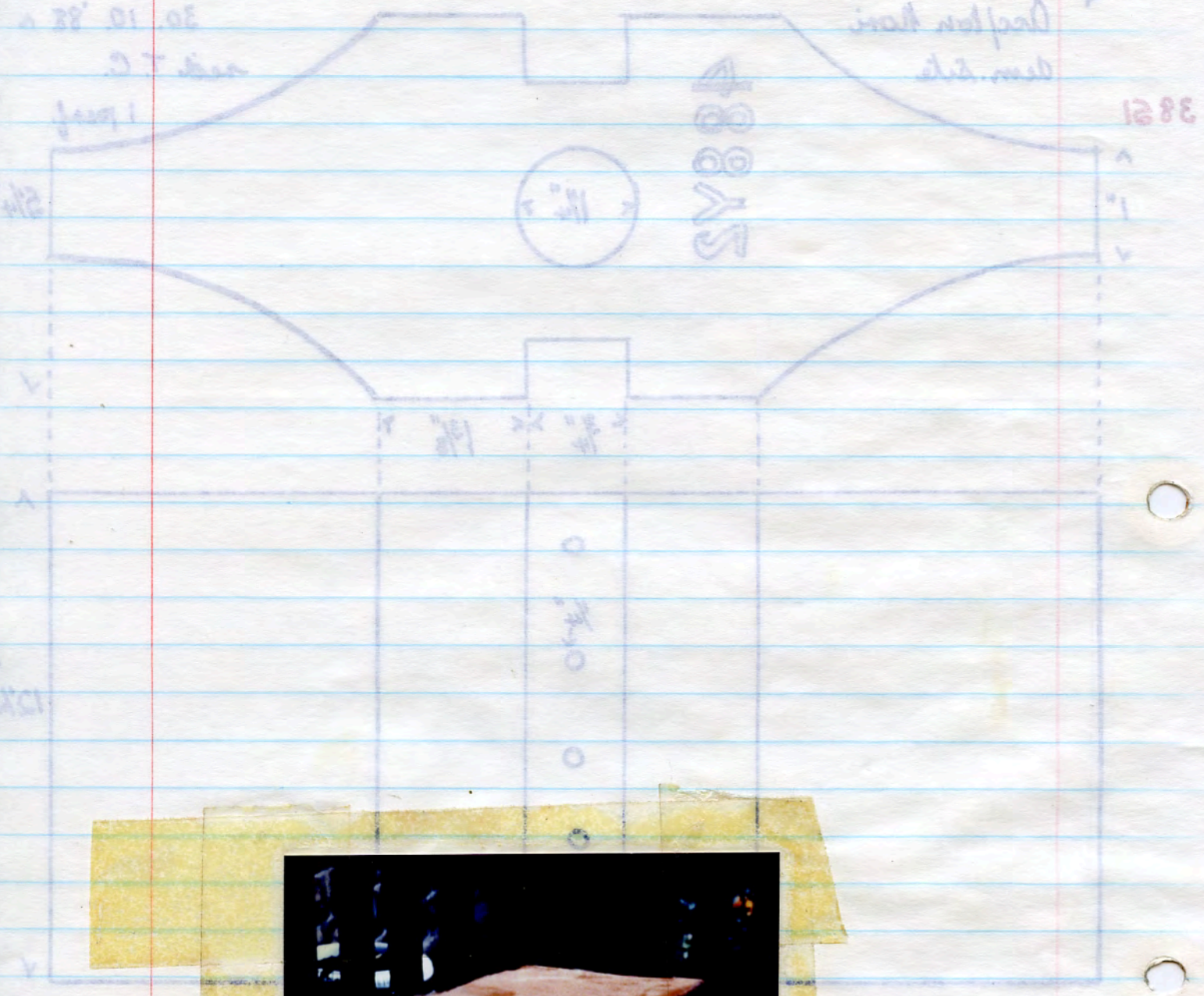

38.81

1/2

3853

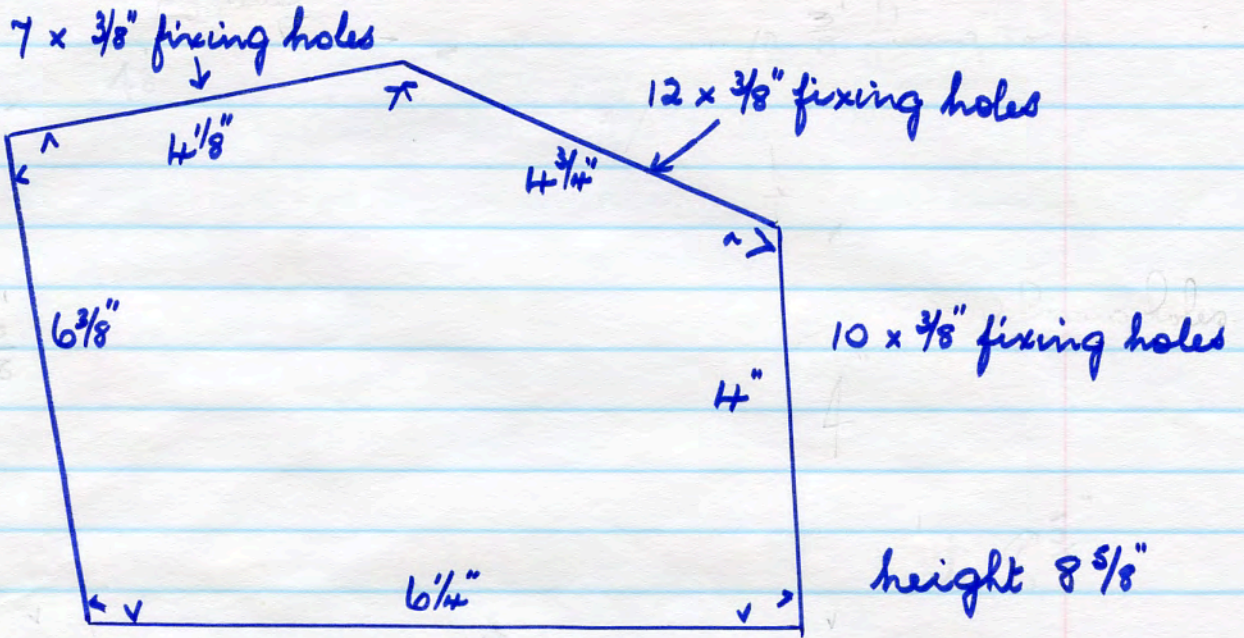

No name. 118 TC red T.C. 28 lbs

No flange on rev. at this side - for 1 7/8" top and bottom.

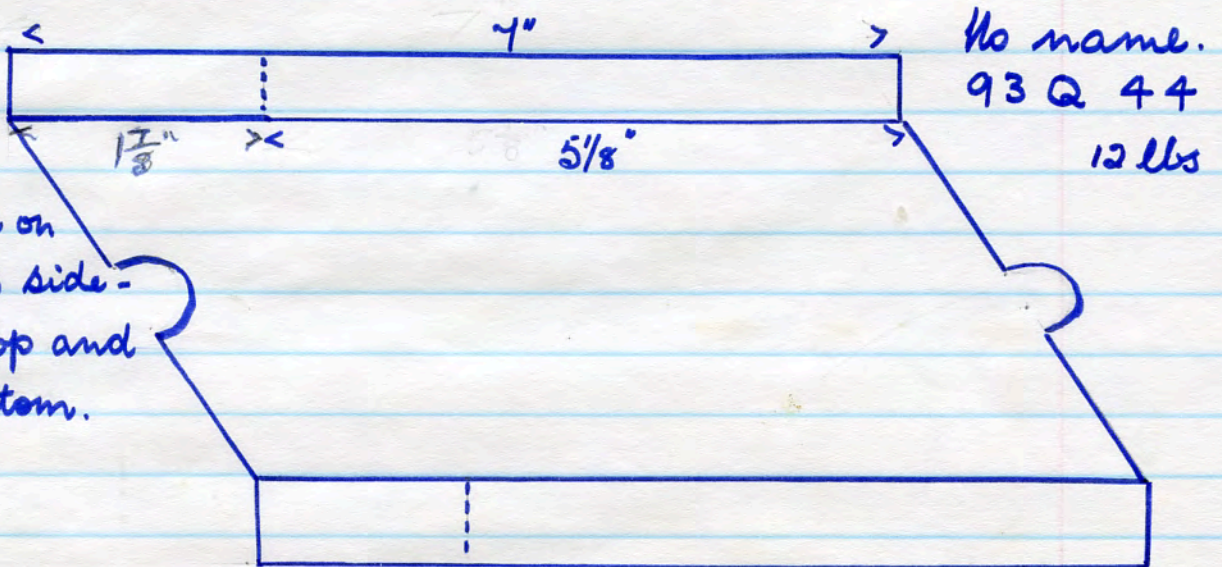

3854

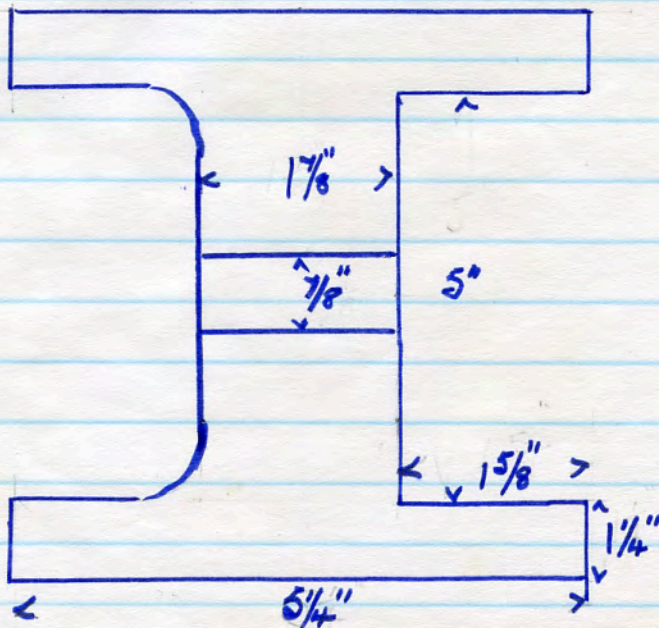

3855

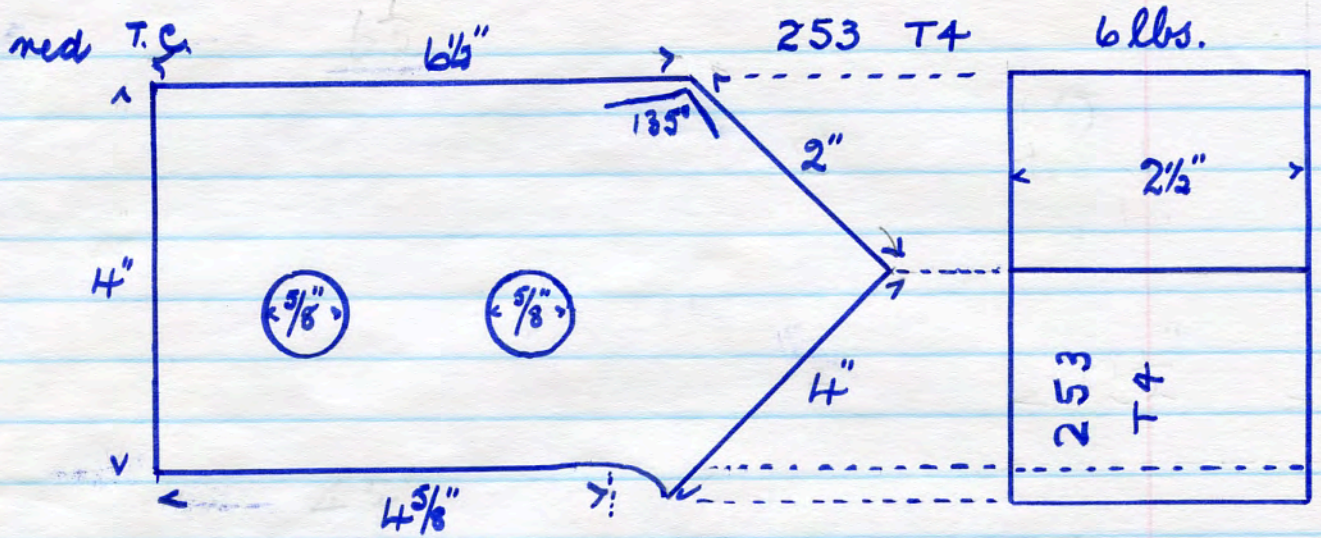

No name. 338 TA red T.C. corbel or jamb 10 lbs.

3856

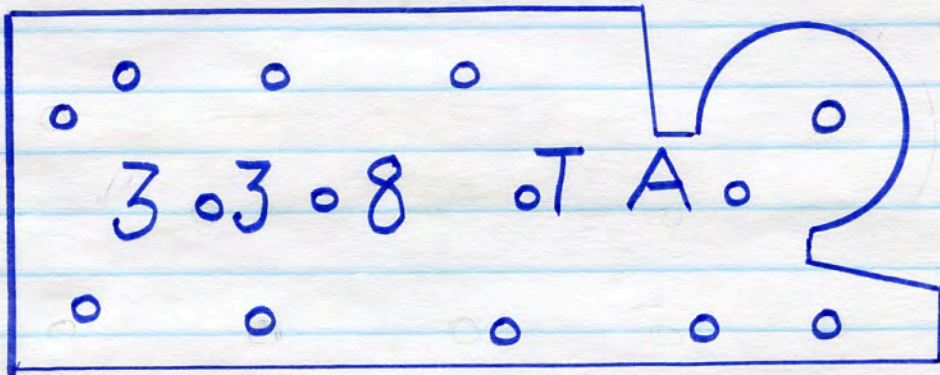

14 stud holes. numbers scribed on 1 side

No name 2342 red T.C. double pillar brick. 7 lbs.

3857

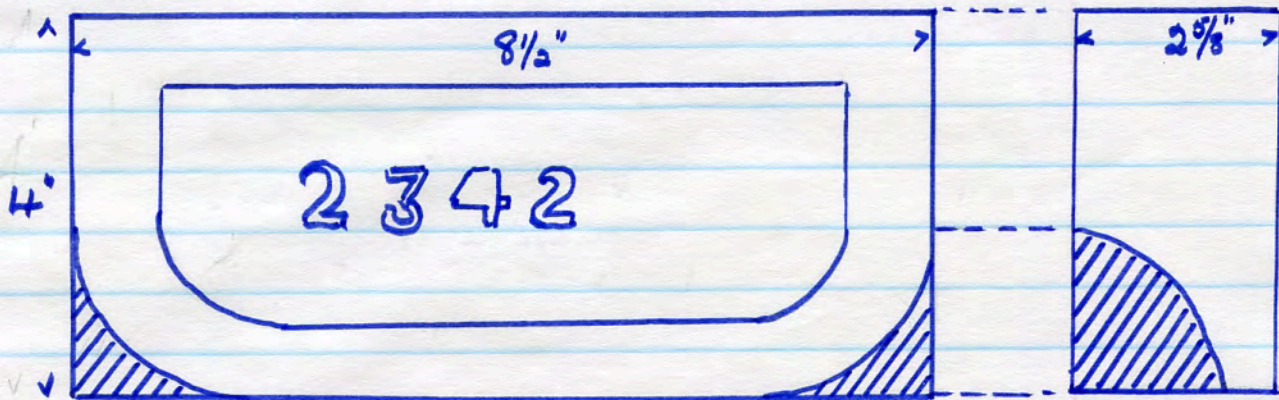

No name. 12 HP red T.C. 2 lbs. length 2 7/8"

3858

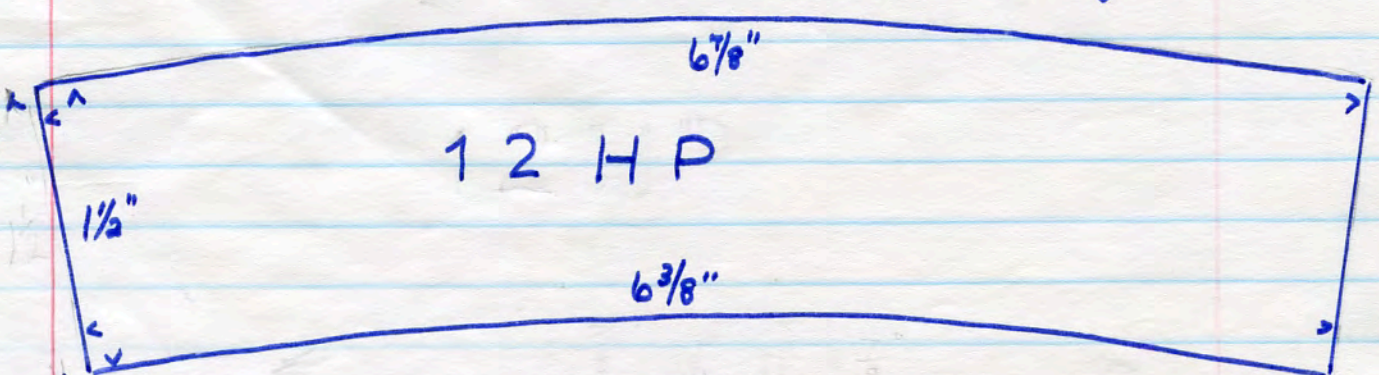

No name. 45 D BEVA. red T.C.
15 lbs.

3859

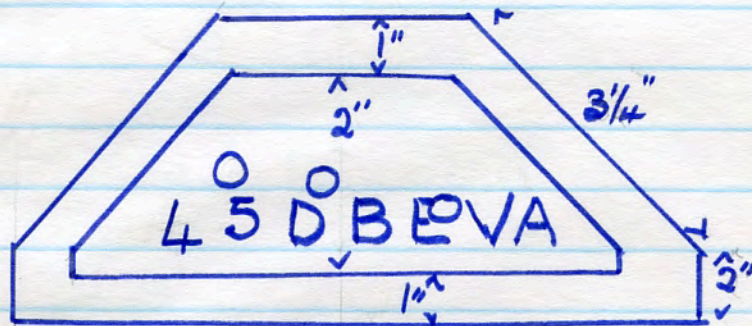
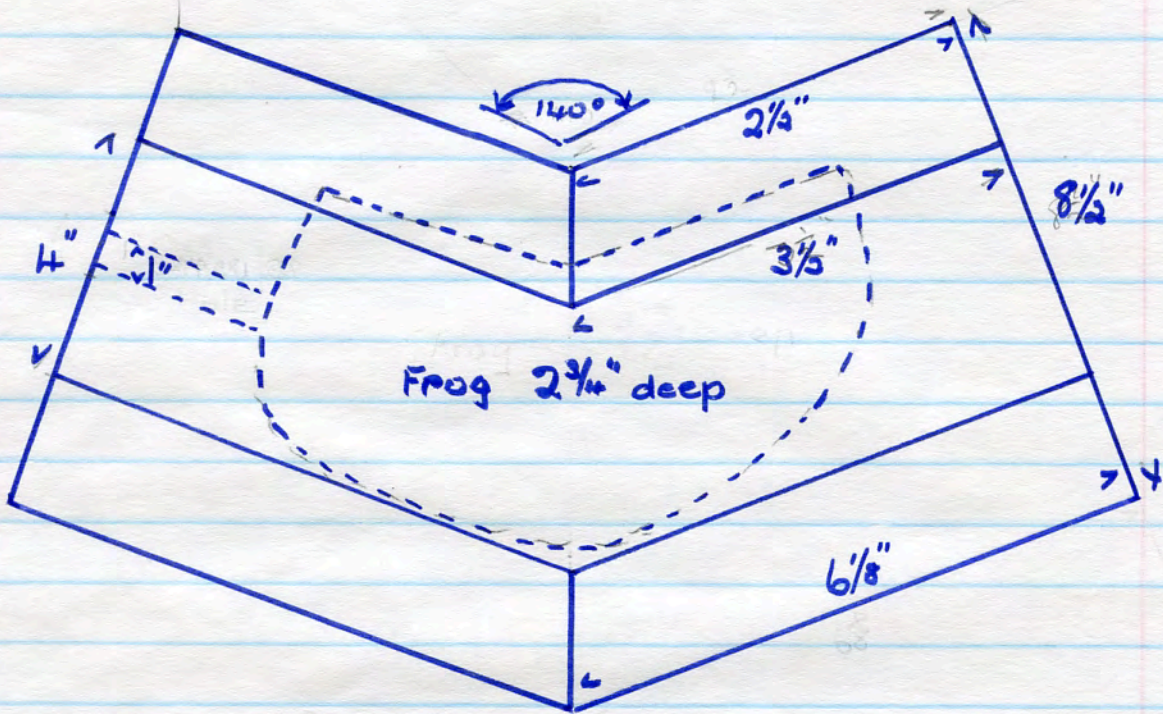

No name. 450 397 red T.C. 2 lbs.

3860

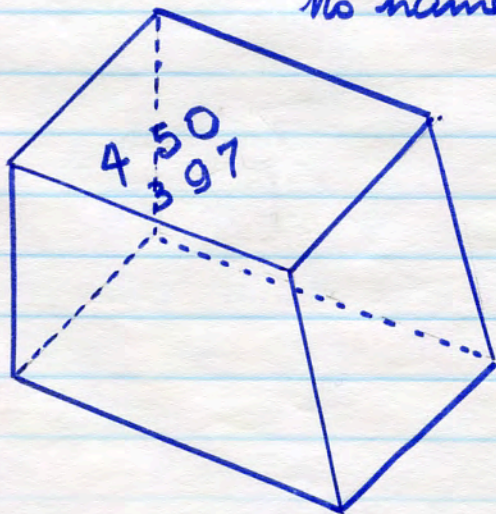

Acc/ton Mori dem. site 30. 10. 88

No name. P2H red T.C. 2 lbs Acc/ton Mori dem. site 30. 10. '88.

3861

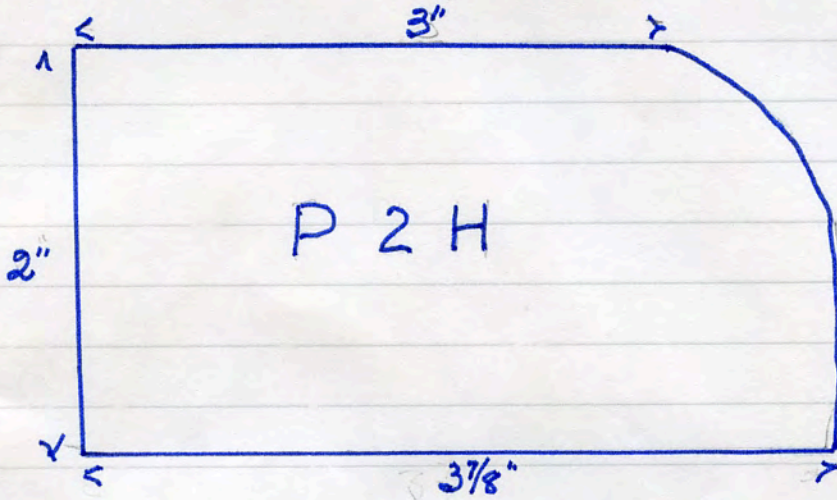

3862

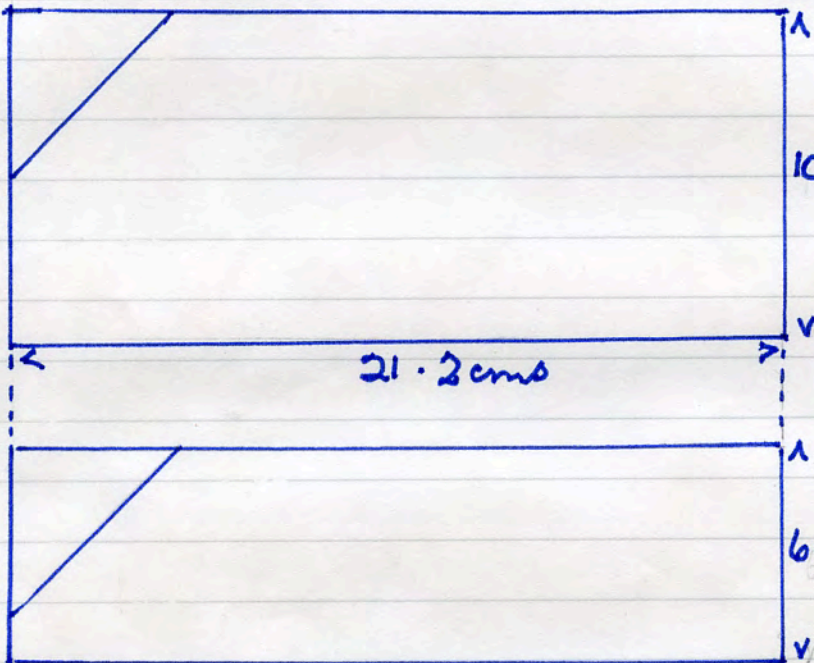

No name
2511 R.D.
wise run
Bowland Brown
8 lbs
jamb.
Acc/ton Mori
dem. site
3. 7. '90

3863

No name. 86 MEX. red T.C. 3 1/2 lbs 2 7/16" thick

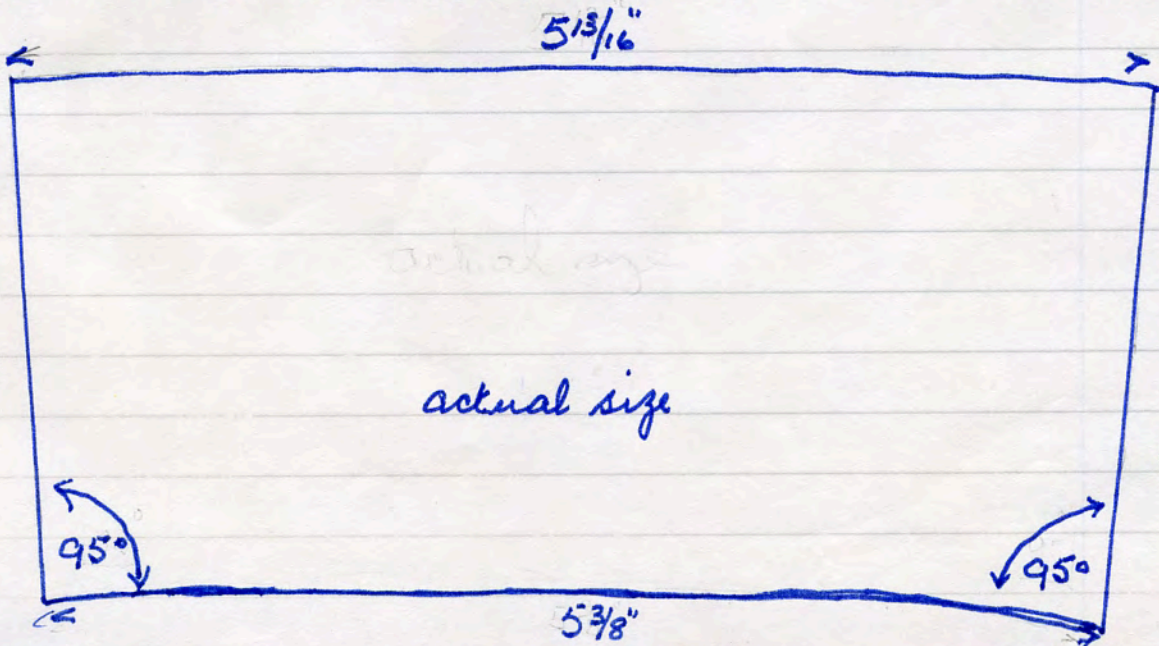

Acc/ton
Mori
dem.
site
30.10.'88

No name. 57H2 red T.C. 9lbs. width $4\frac{7}{16}$ "

3864

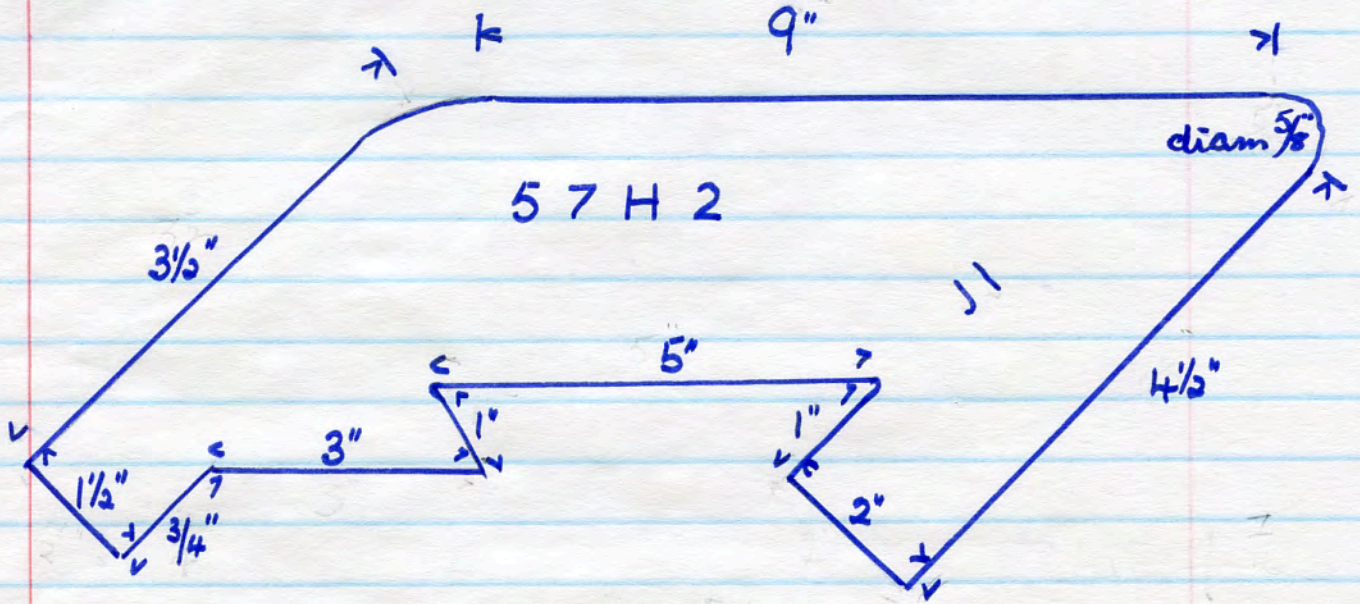

3865

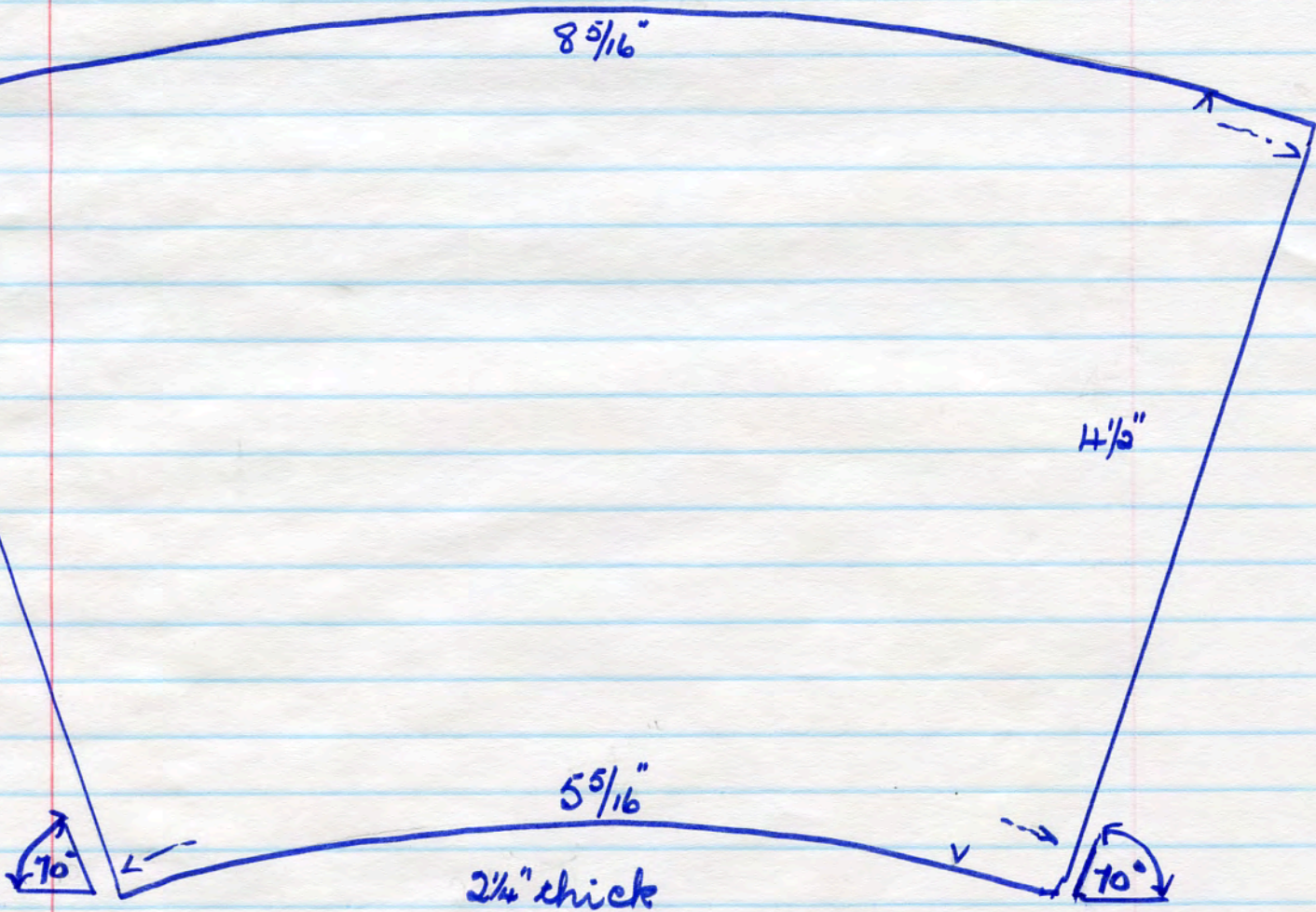

No name OZ 45C scribed on 1 side. red T.C.
4 lbs.

Acc/ton Mexi dem. site 30. 10. '88

No name
8 lbs.

303 TJ
red T.C.

21 perfs $\frac{3}{16}$ "
in base.

3866

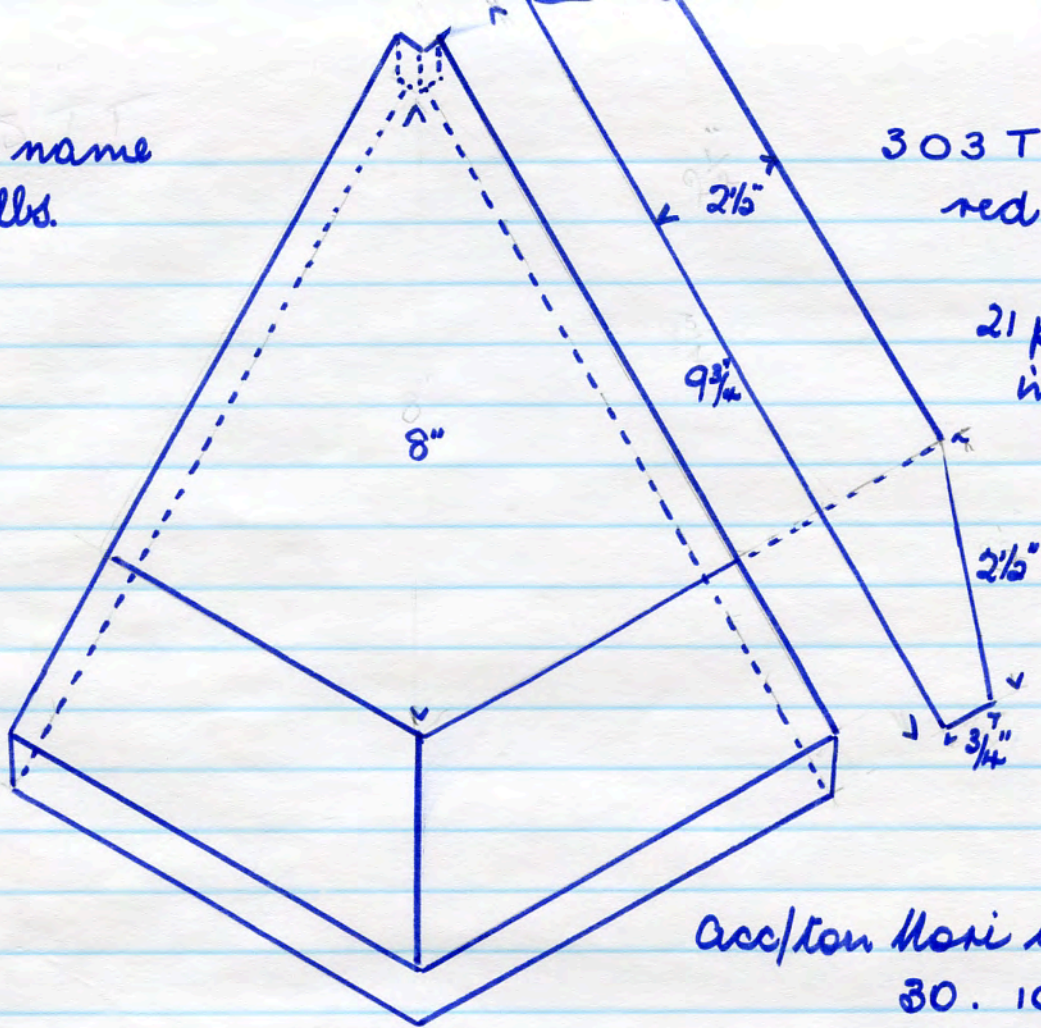

Acc/ton Mori dem. site
30. 10. 88.

3867

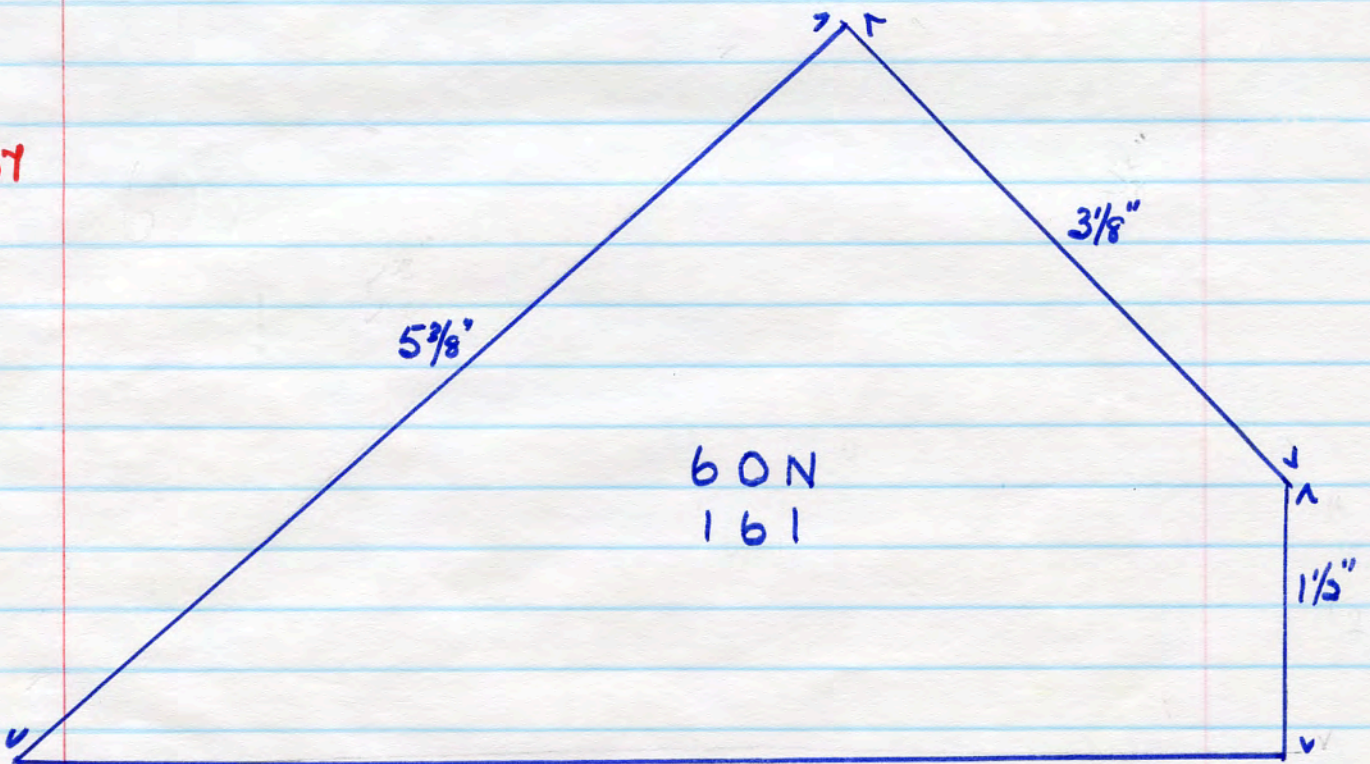

No name. 60N 161 red T.C.
3 lbs $2\frac{7}{8}$ " thick
Acc/ton Mori dem. site. 30. 10. '88

3868

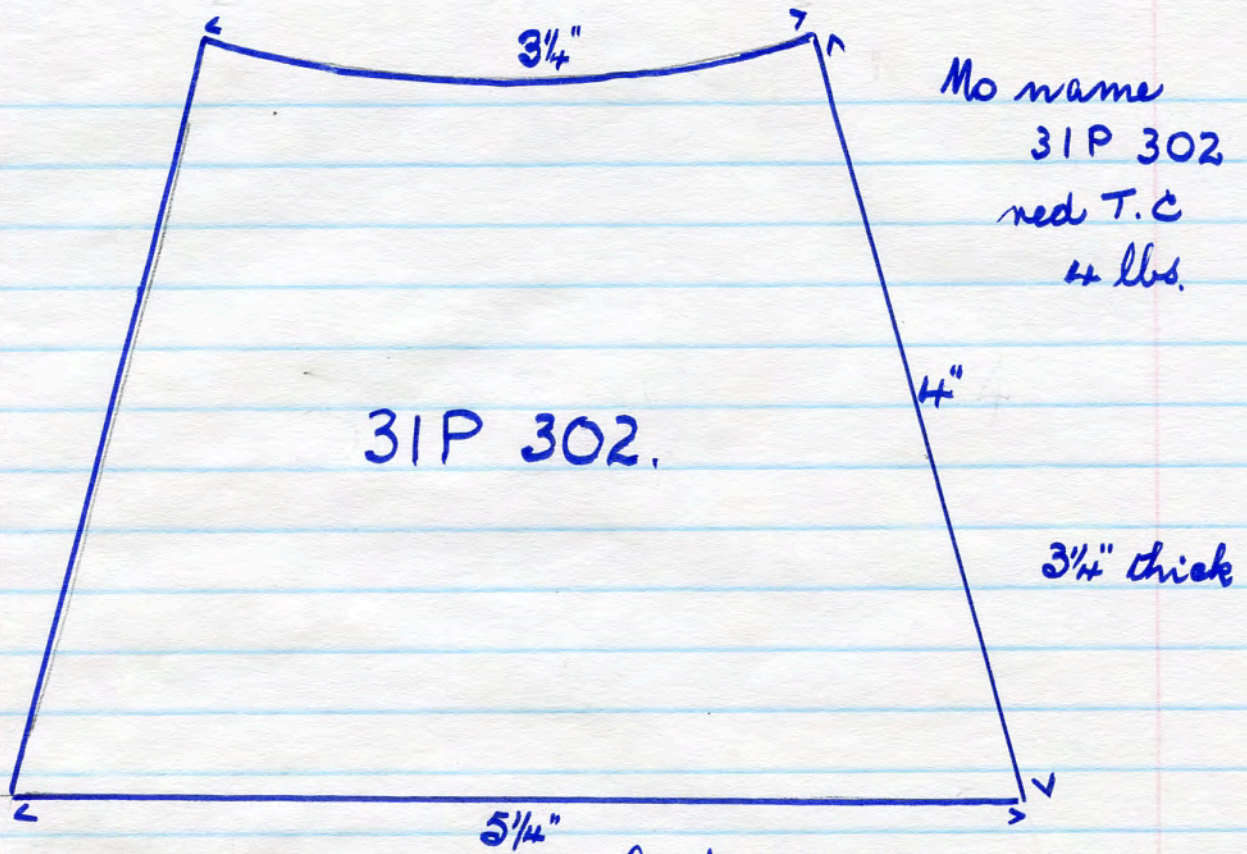

Accepton Nori dem. site 30. 10. 88.

3869

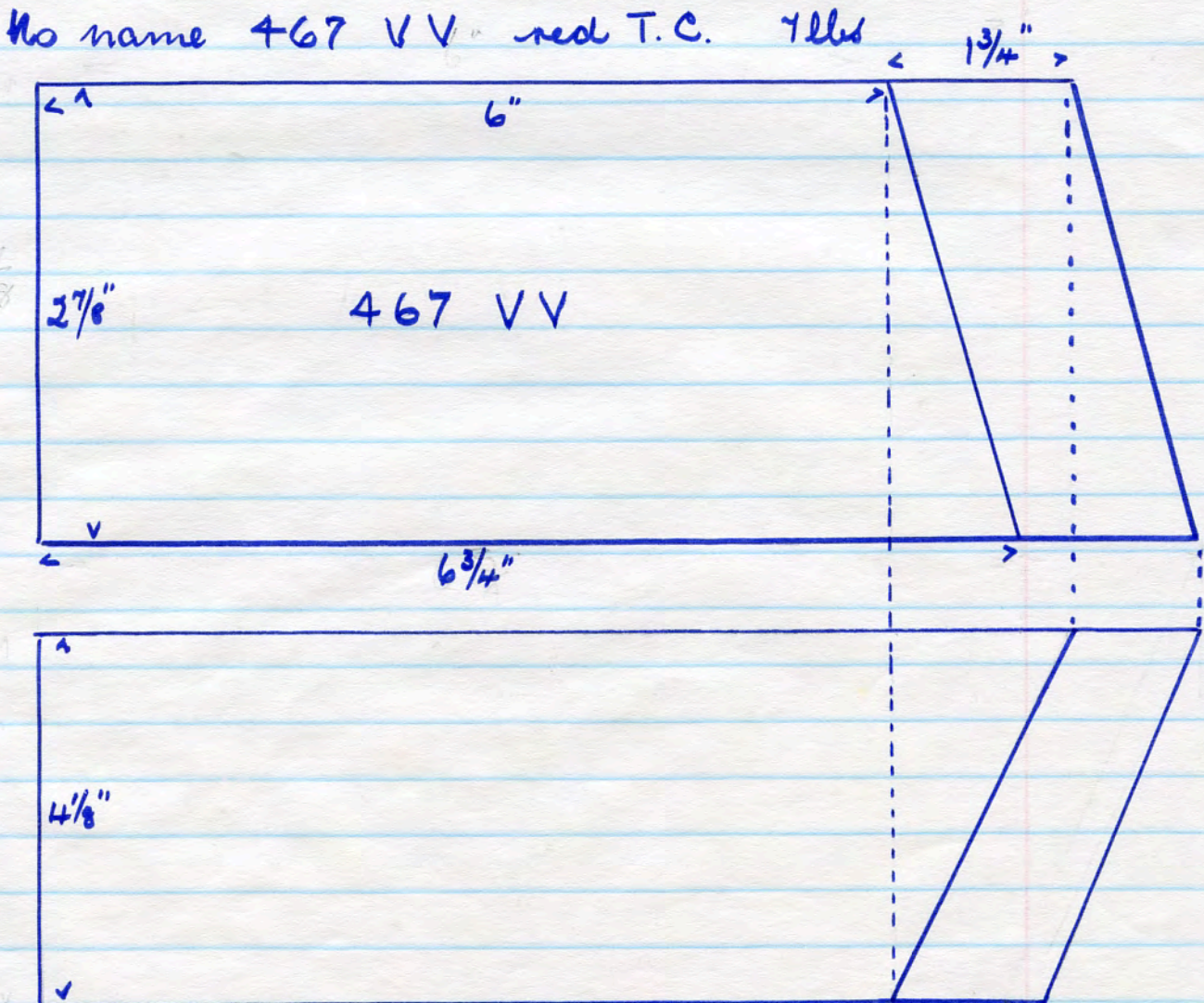

Accepton Nori dem. site 30. 10. 88

3870

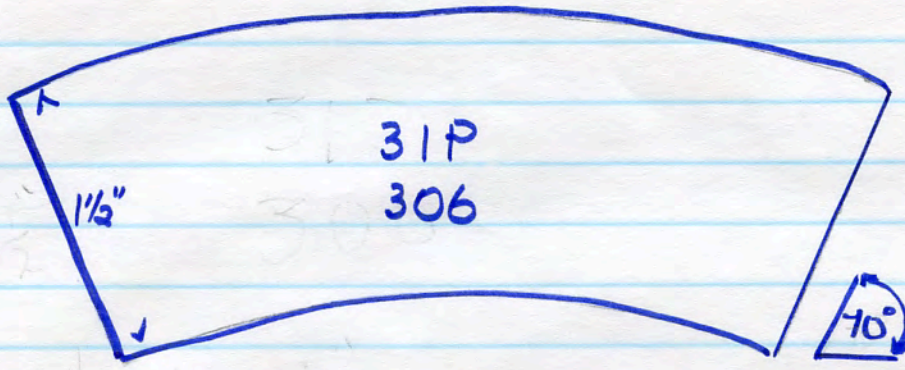

length $9\frac{1}{4}$ "

No name. 31P 306 red T.C. 4 lbs.

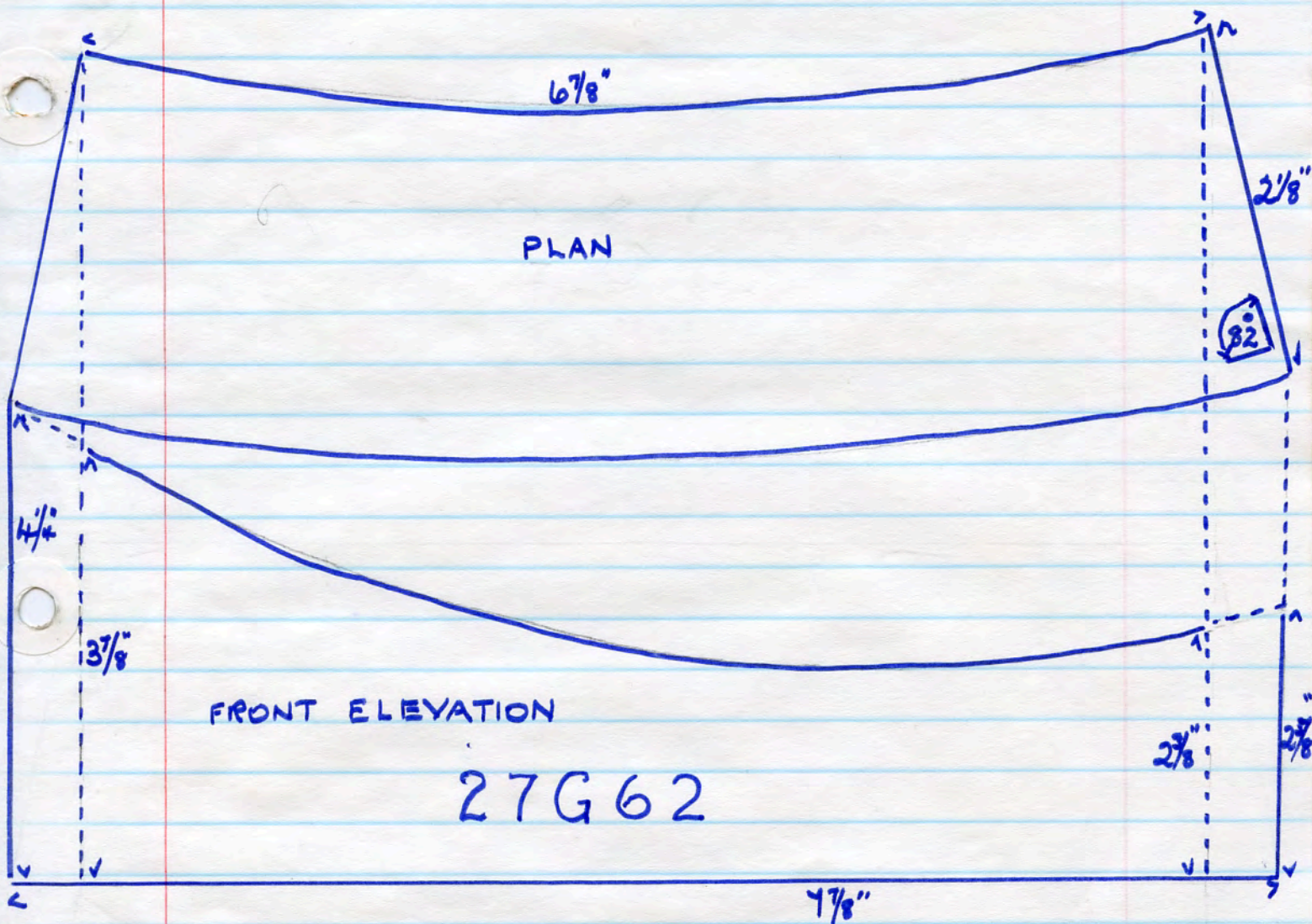

3871

No name. 27G62 red T.C.
 4 1/2 lbs. letters stamped.
 Acpton Mari dem. site 30. 10. '88.

No name 113U red T.C. 7 lbs.

3872

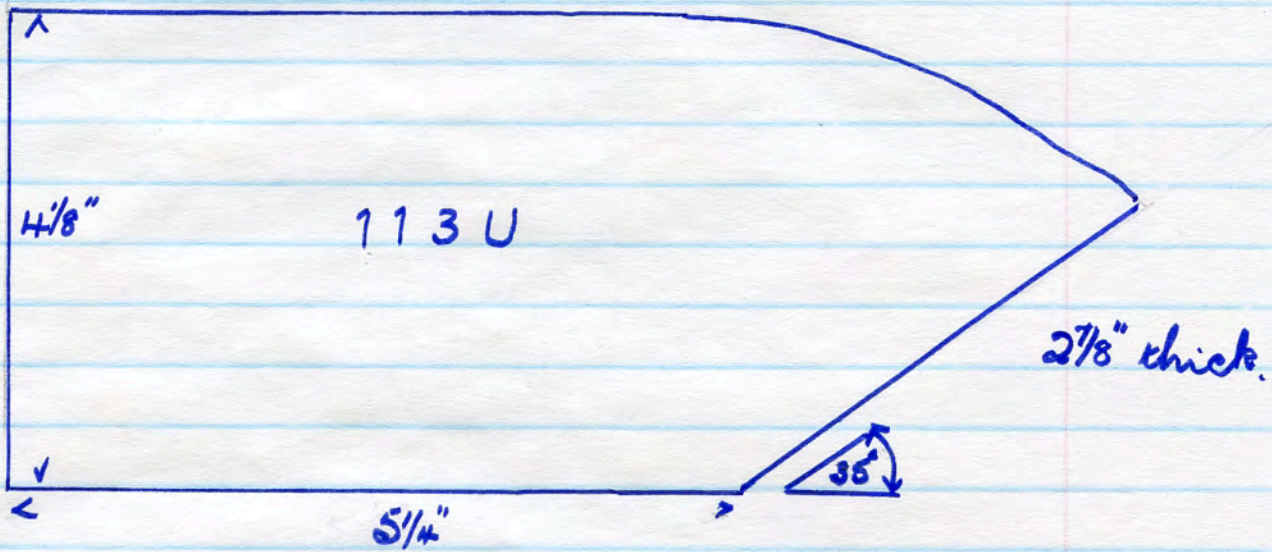

No name. 195T 10 lbs.
dark brown T.C.

3873

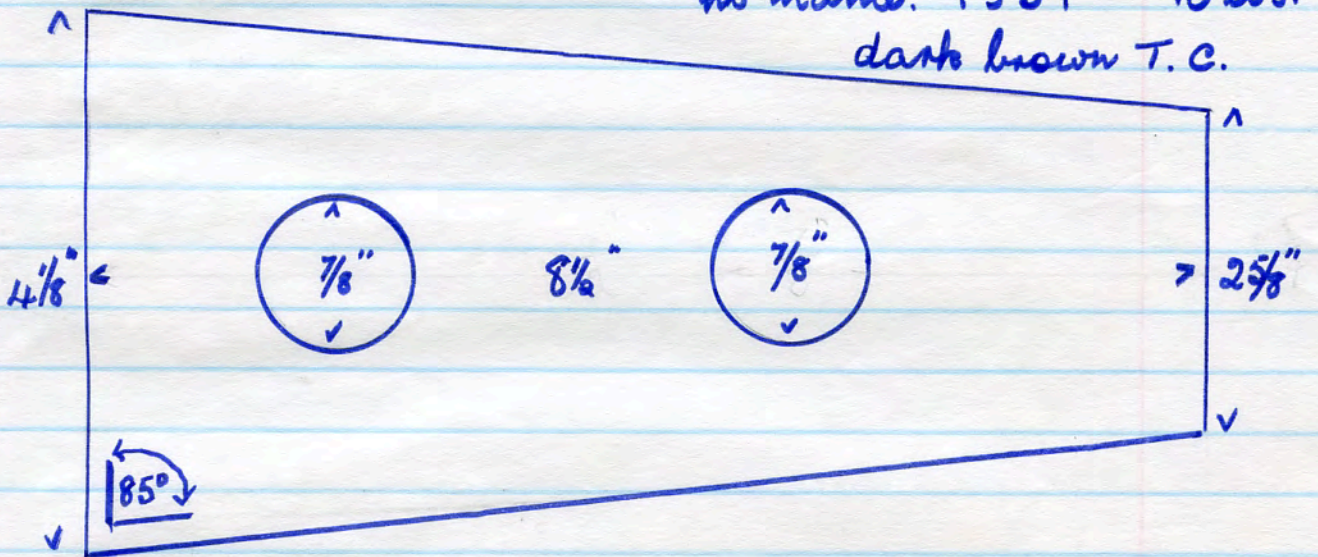

3874

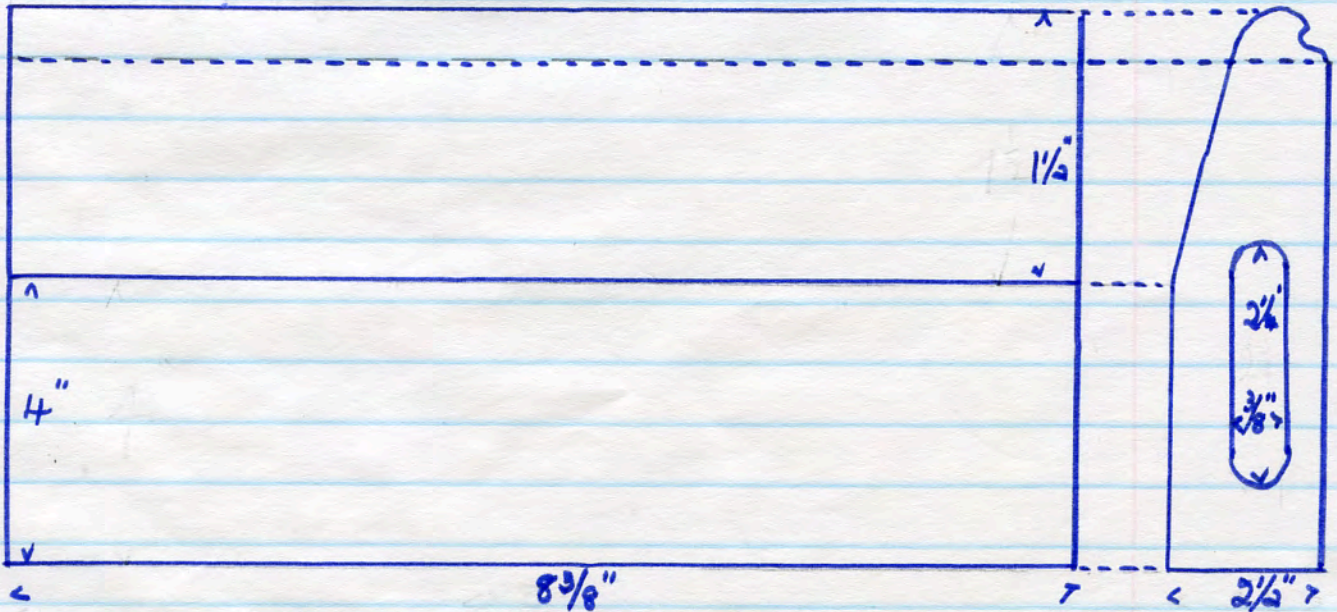

No name. 2AMD dark brown T.C (unfinished surface)
9 lbs. Acc/ten Mori dem. site 30. 10. 88.

3875

No name 27 G 24 red T. C.
5 1/2 lbs 2 3/4" thick.
Acc/lon Moni dem. site
30. 10. '88.

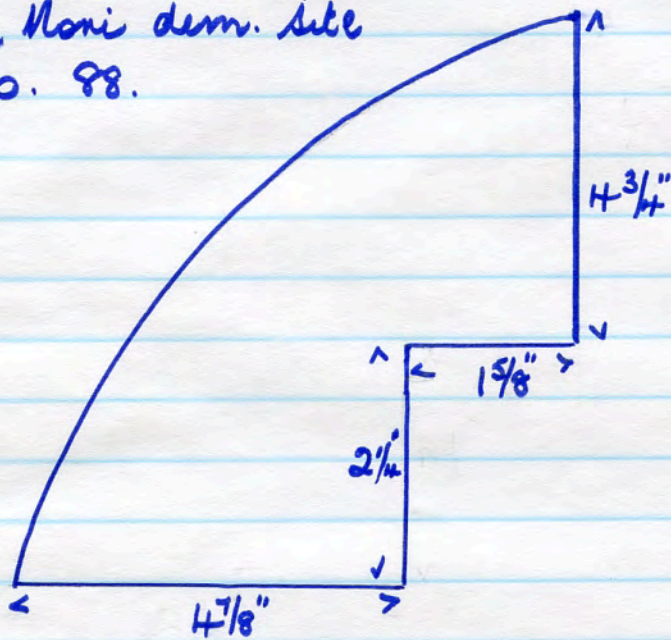

3876

No name. 233 2R
8 lbs.

red T. C. jamb

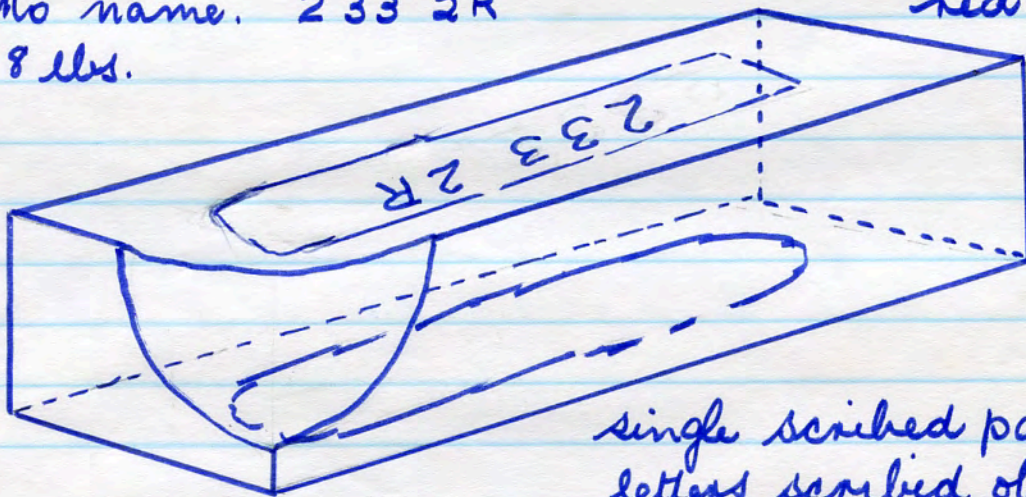

single scribed panel each side
letters scribed obv. only.

Acc/lon Moni dem. site. 30. 10. '88.

3877

No name
890A
4 1/2 lbs

red T. C.

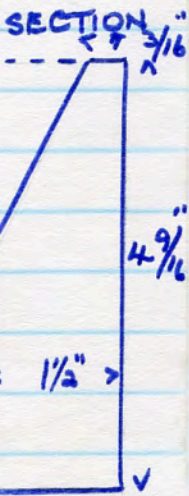
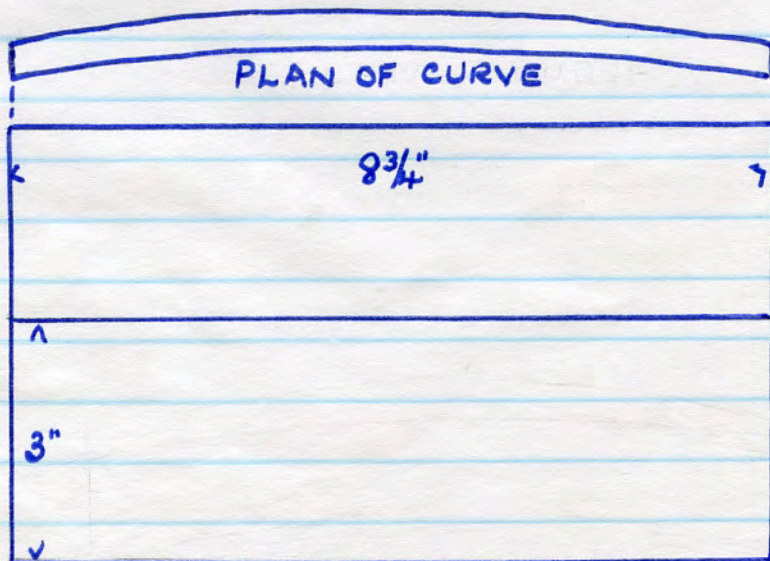

FRONT VIEW

No name
12 lbs

921 VA

red T.C

$3 \times \frac{1}{2}$ " perfs each
side.

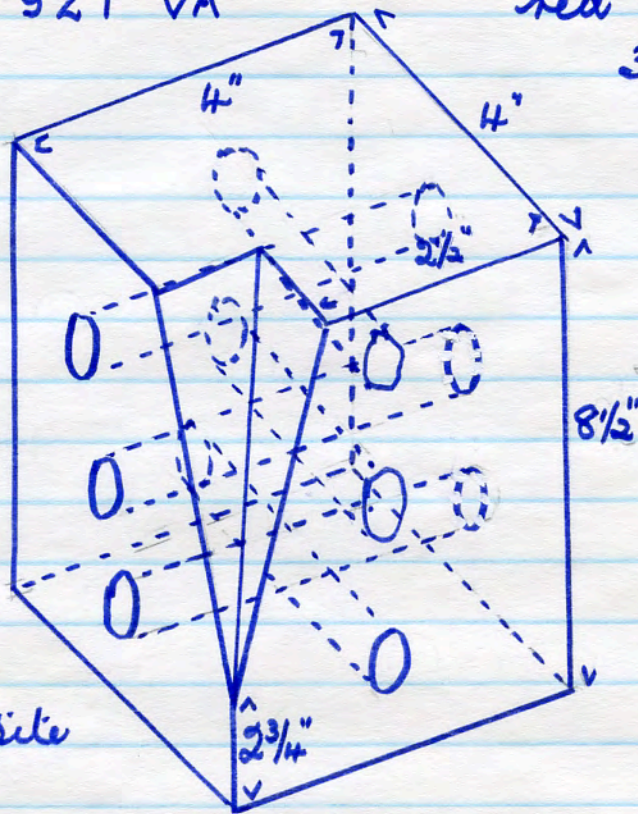

3878

Acc/ton dem site
30. 10. '88

No name.
8 lbs

31P296

red T.C.

3" thick.

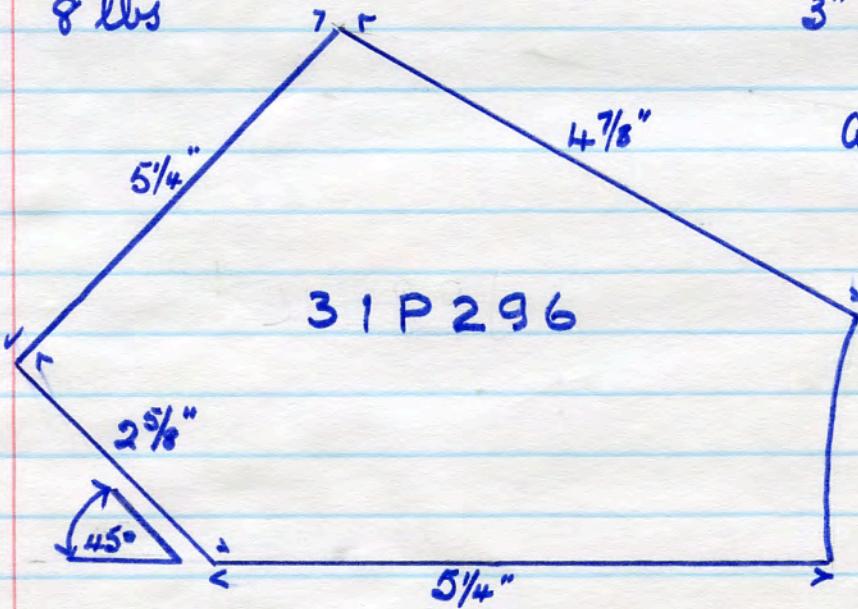

3879

Acc/ton Hori dem. site
30. 10. '88

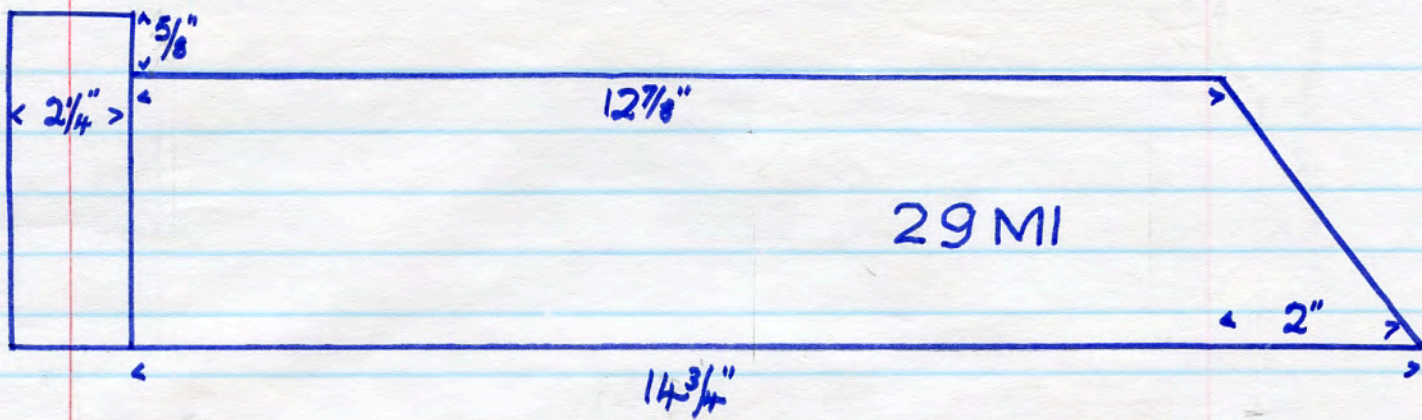

3880

No name. 29 MI red T.C
6 lbs 1 of 6 segments for circular drop.

Asc/ton Mori dem. site 30. 10. '88

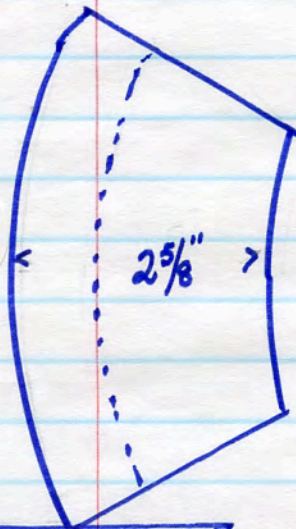

No name. 52 B 19Z
7 lbs. red T.C.
2 perfs 3/8" diam.

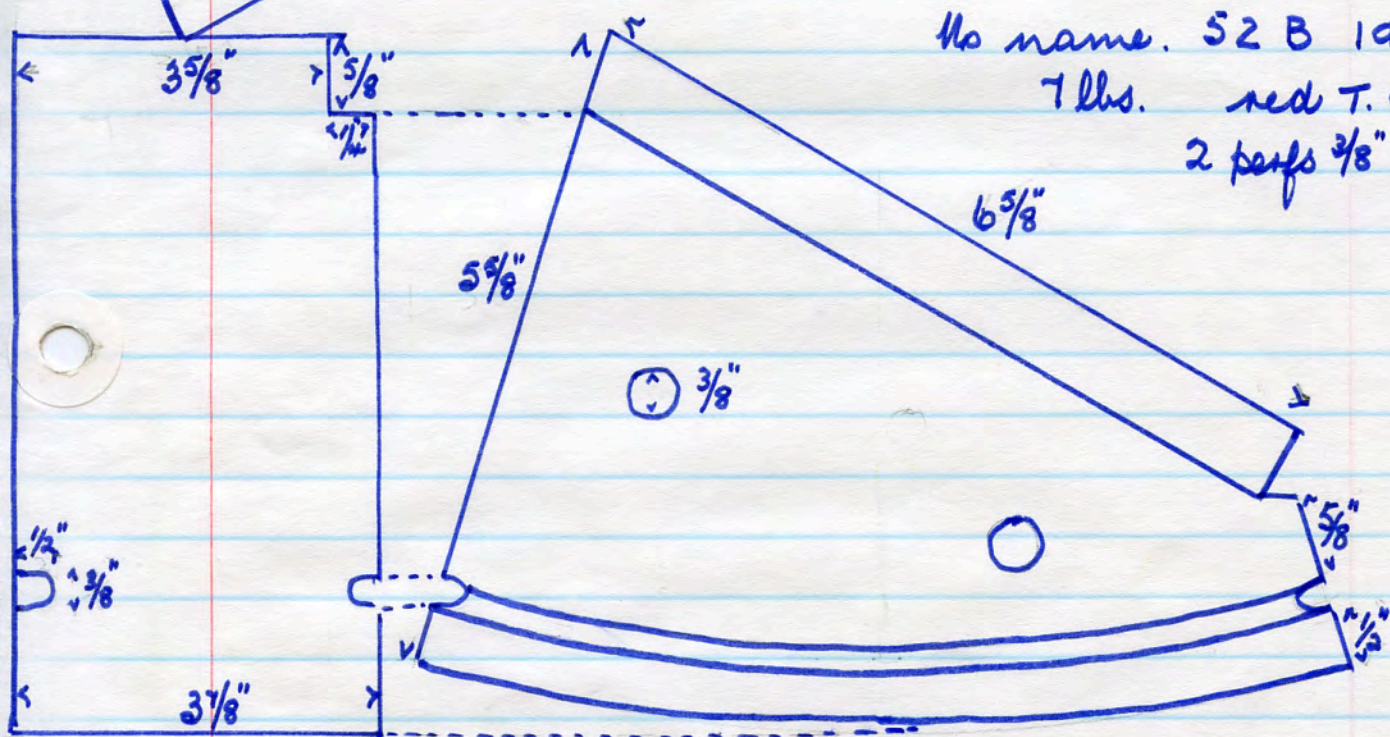

3881

Asc/ton Mori dem. site 30. 10. '88.

3882

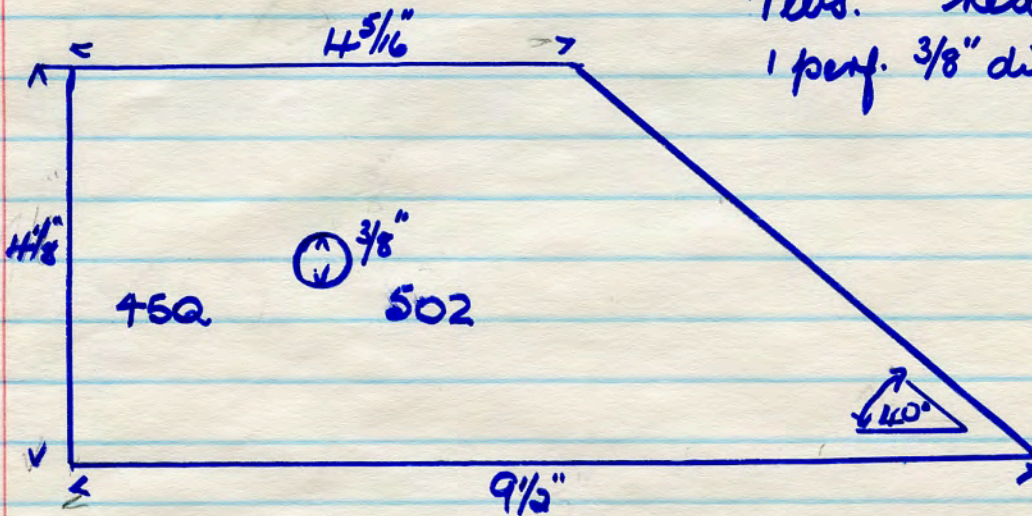

No name 45Q 502
 7 lbs. red T.C.
 1 perf. 3/8" diam.

3883

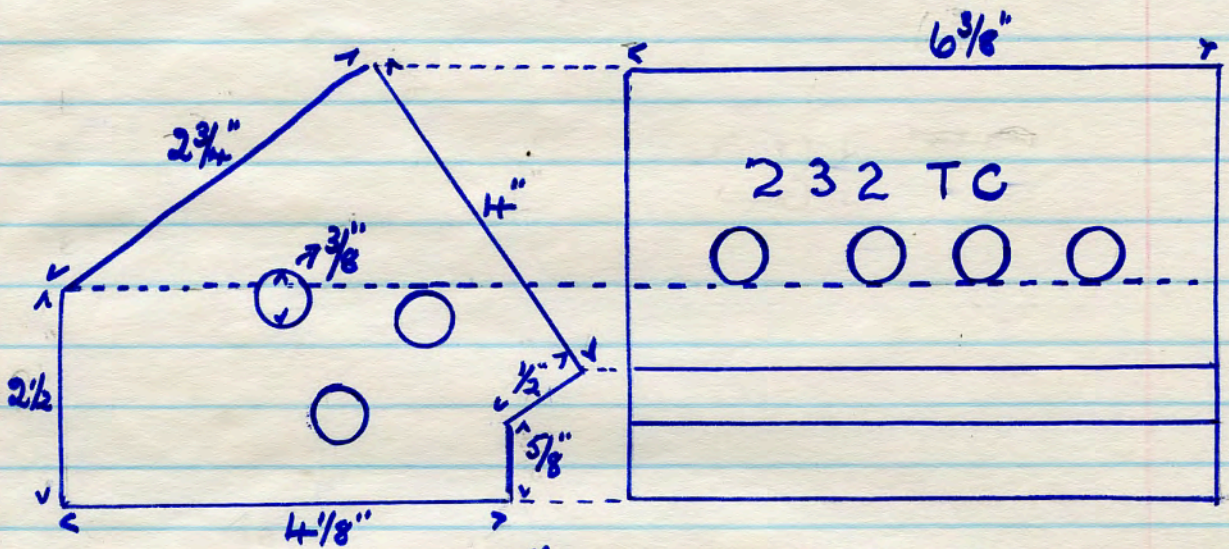

No name 232 TC red T.C.
 7 lbs

Acc/ton Mori dem. site 30. 10. 88.

3884

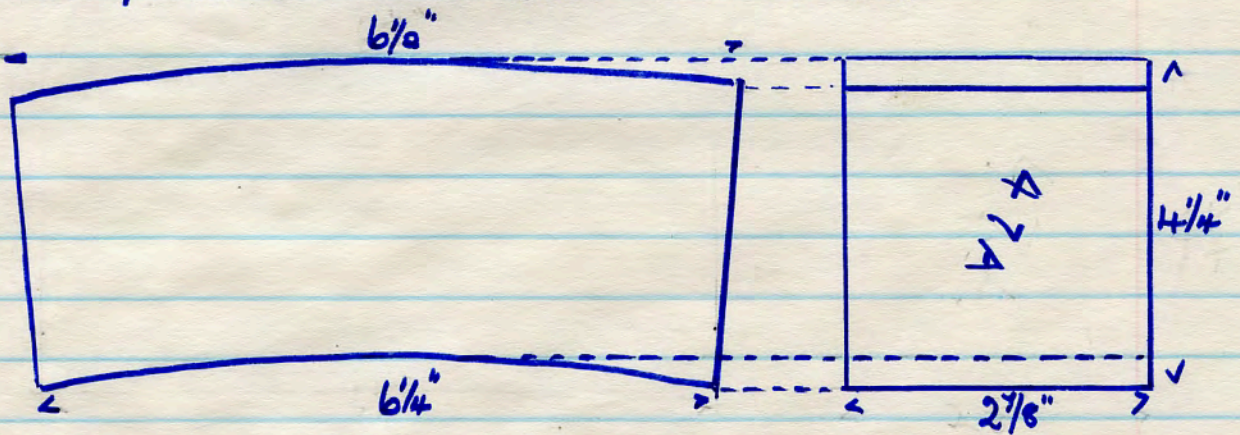

No name. 47A red T.C.
 7 lbs

Acc/ton Mori dem. site 30. 10. 88

3885

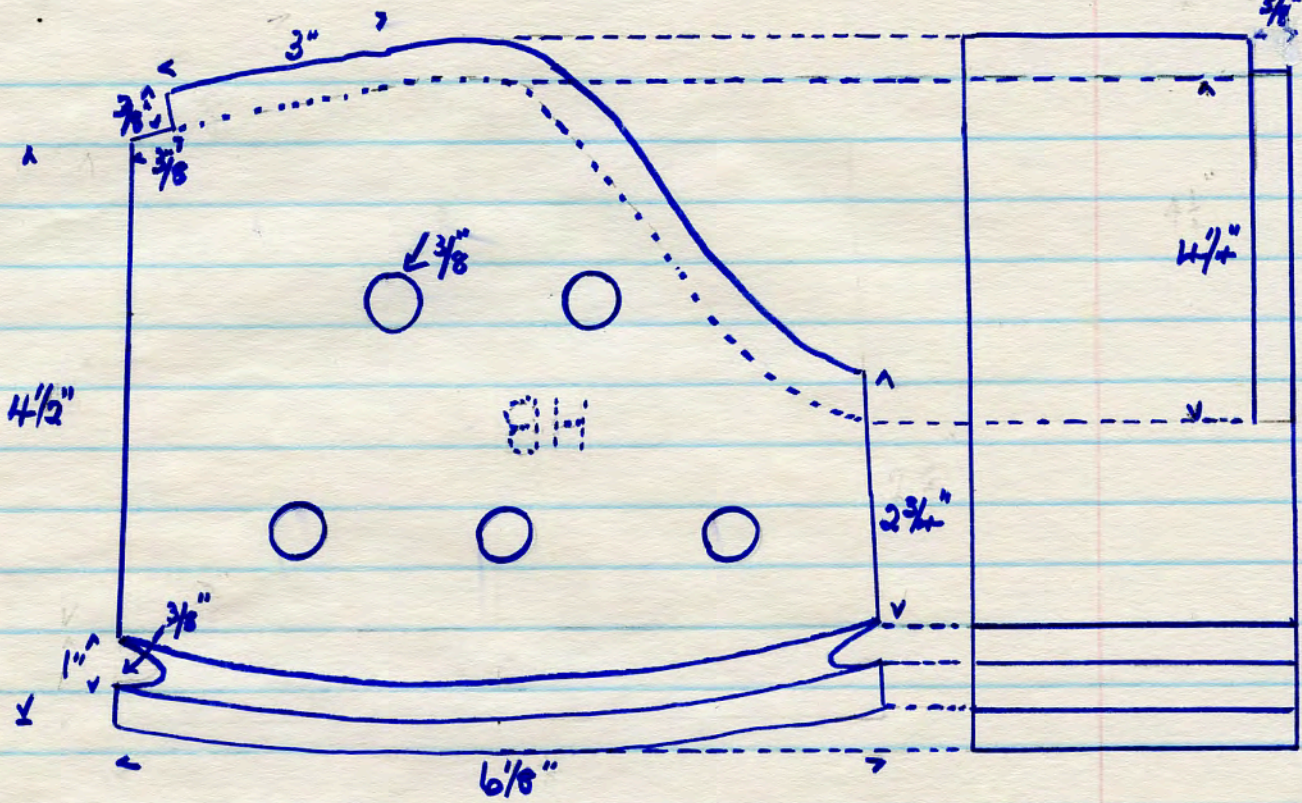

no name. 52820Z red T.C
 11 lbs HB stamped on rev - name of moulder.
 Acc/ton Mori dem. site 30. 10. '88

no name 815 Z1. red T.C.
 10 lbs

3886

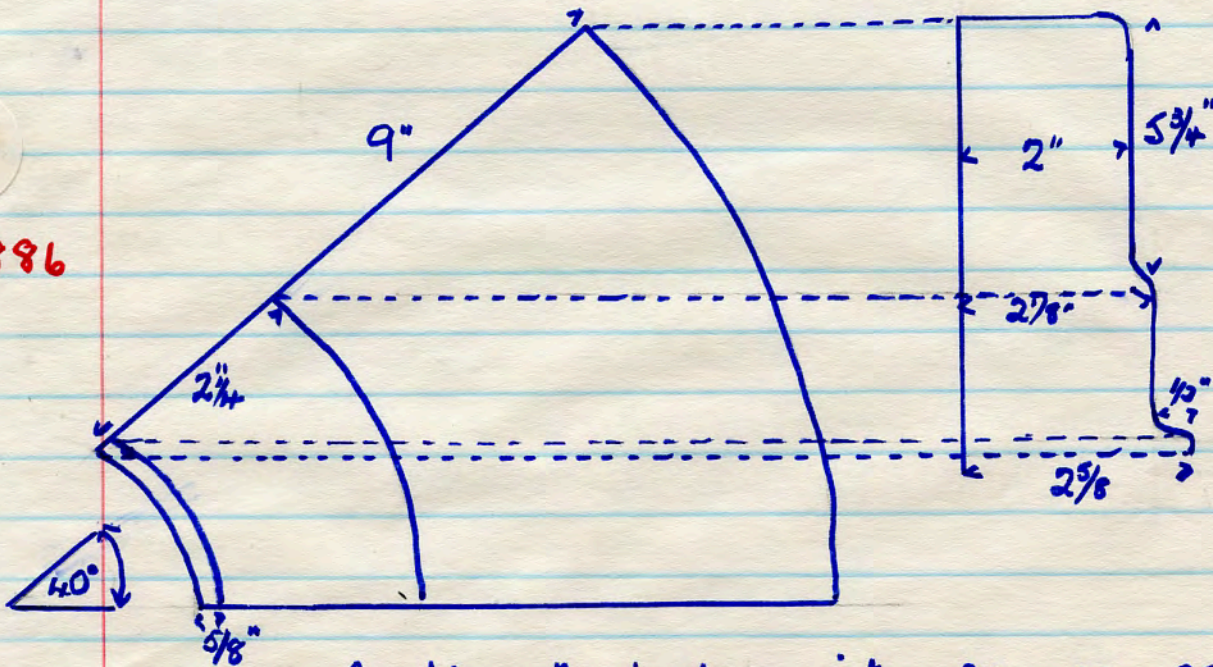

Acc/ton Mori dem. site 30. 10. '88

3887

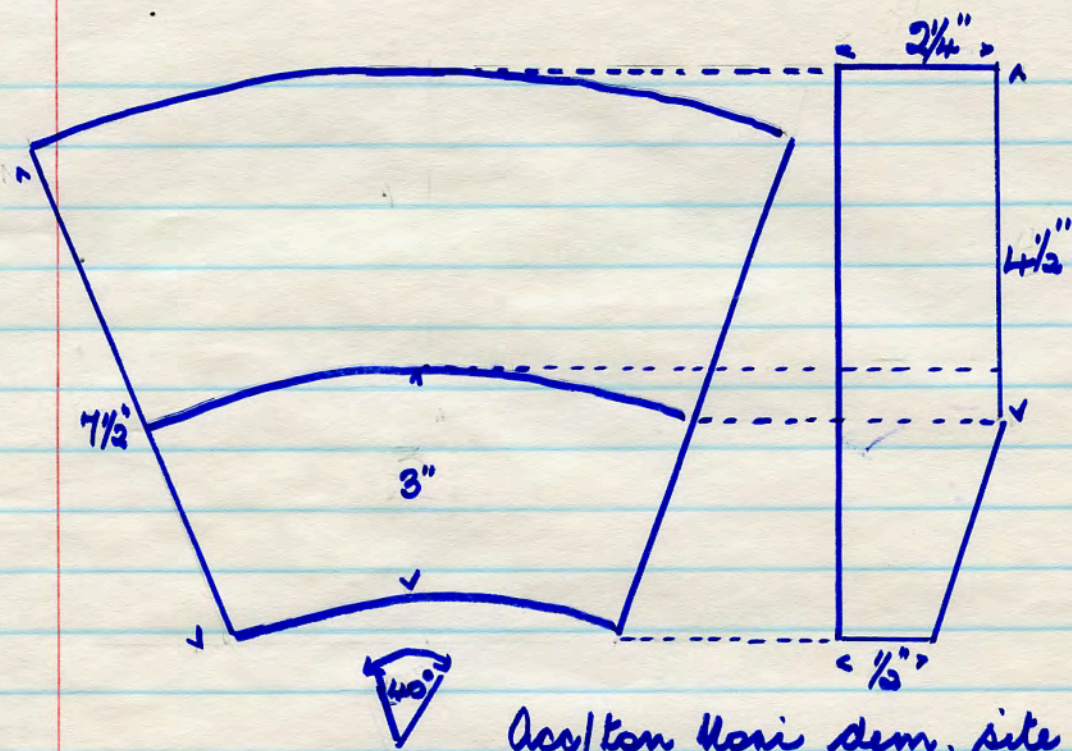

No name
 OZ 44C
 red T.C.
 7 lbs.

Asc/ton Mori dem. site 30. 10. 88.

No name. 29G 22 red T.C.
 26 lbs.

3888

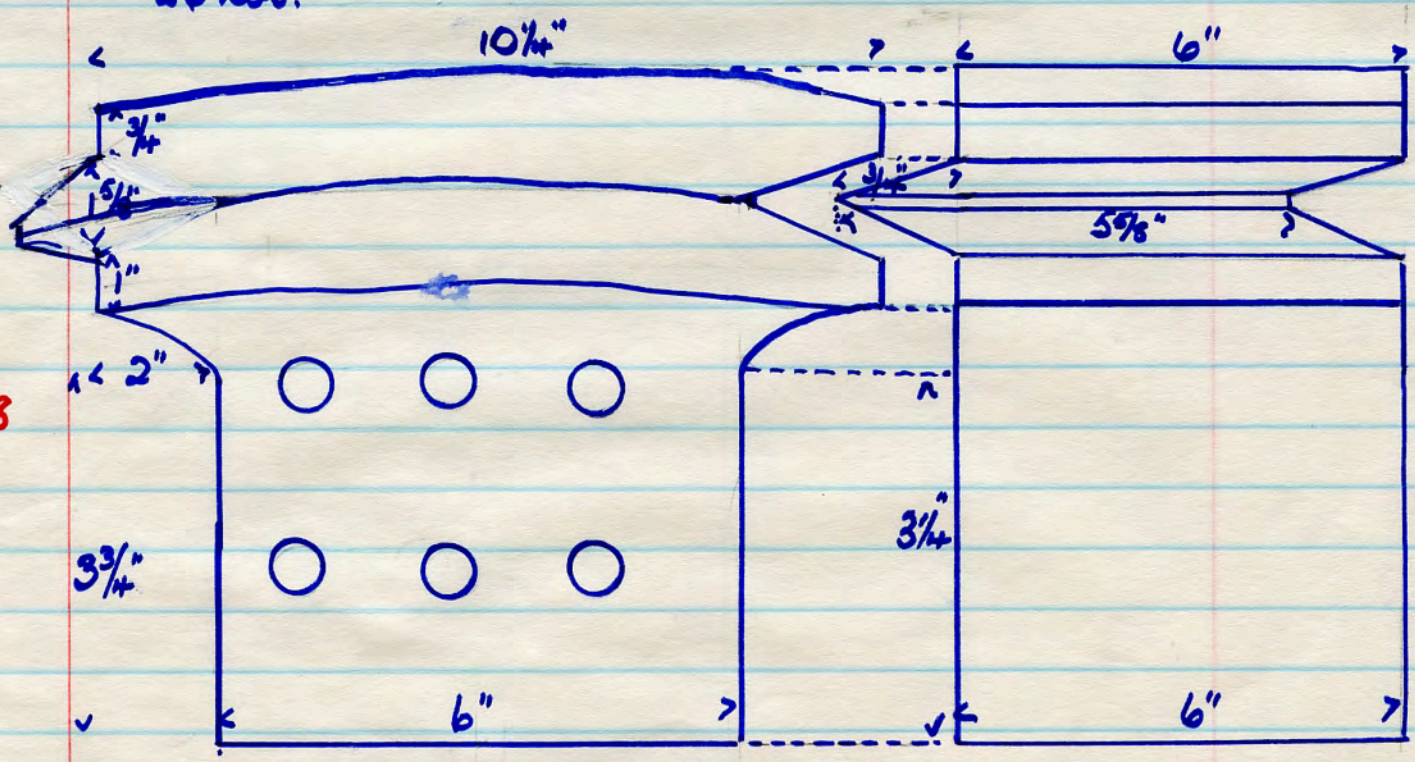

Asc/ton Mori dem. site 30. 10. 88.

3889

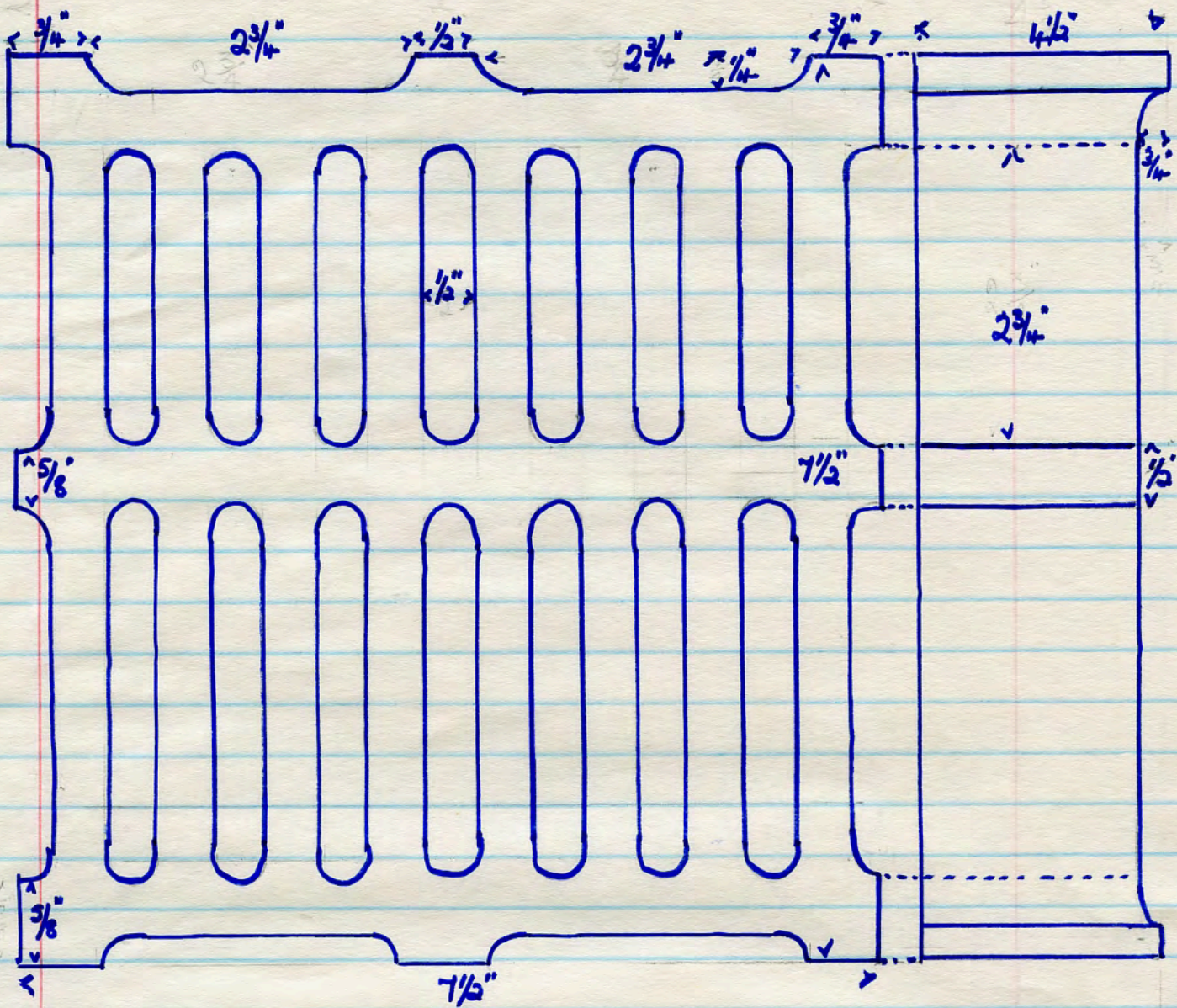

No name. red T.C. 11 lbs. Acpton Hori dem. site
30. 10. '88

3890

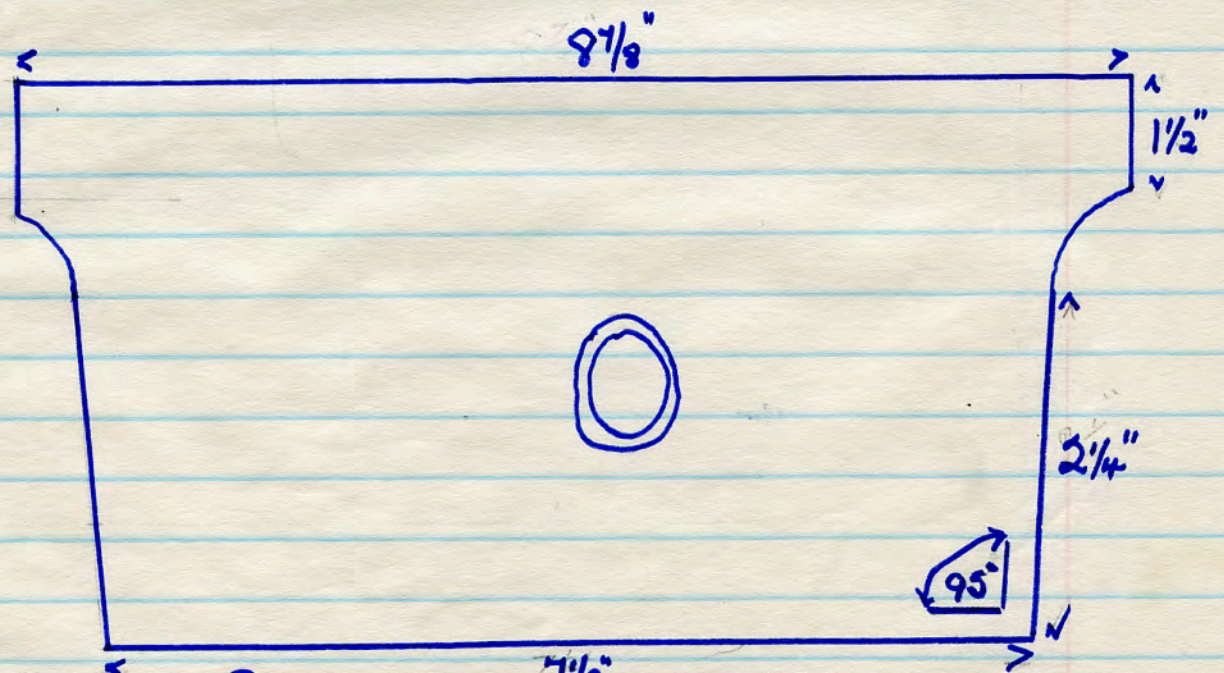

No name (O) red T.C. $7\frac{1}{8}$ 8 lbs
Acpton Hori dem. site 30. 10. '88

dark brown
 No name red T.C.
 276 1XC
 15 lbs.

3891

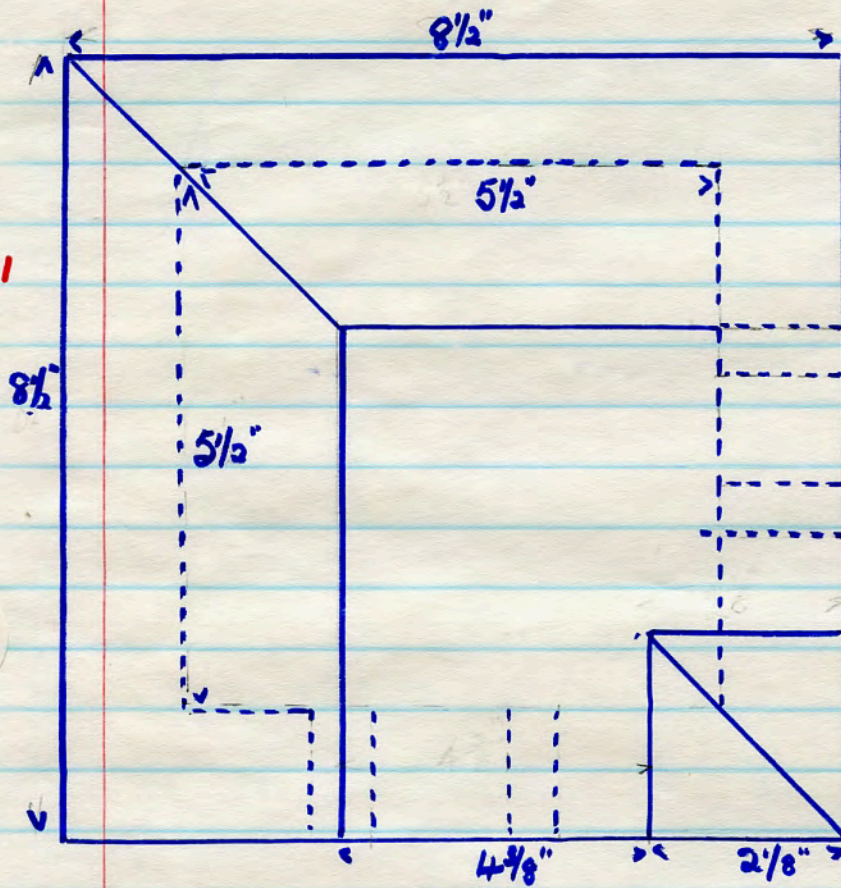

Acception Mori dem. site
 30. 10. 88.

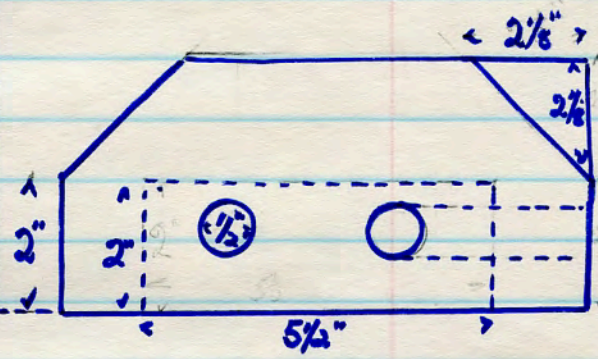

3892.

No name red T.C.
 27G1H
 9 lbs.

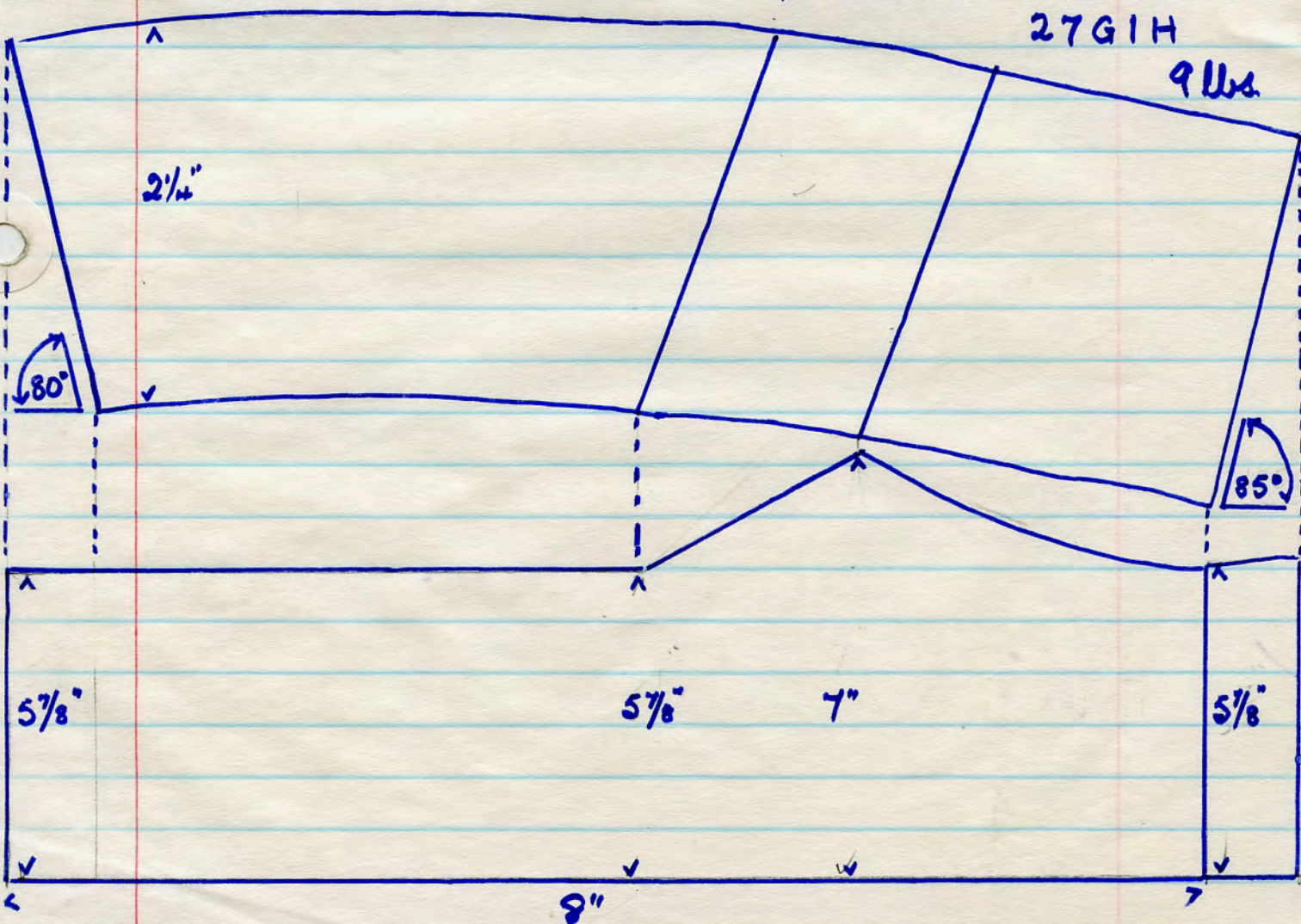

No name 175 ZAV red T.C. tile 8 lbs.

3893.

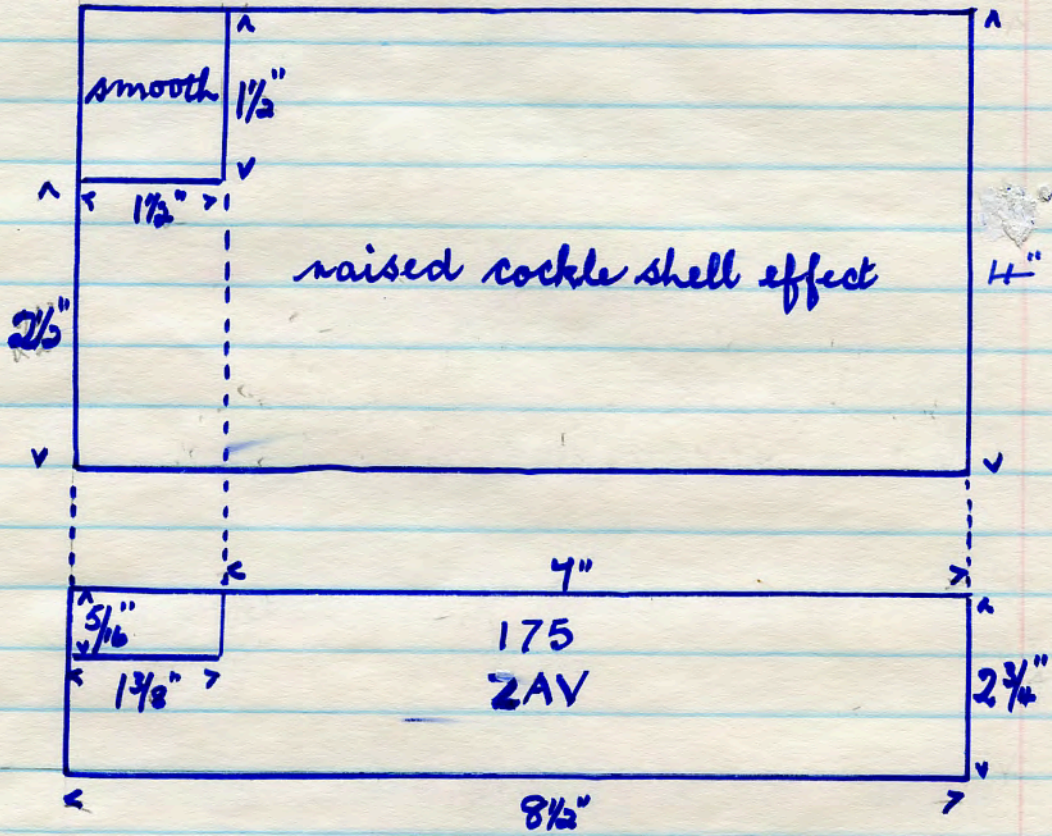

No name POFN5 red T.C. tile 8 1/2 lbs.

3894

specifications as 3893 but right hand square rebate
thickness is 2 1/2" thick.

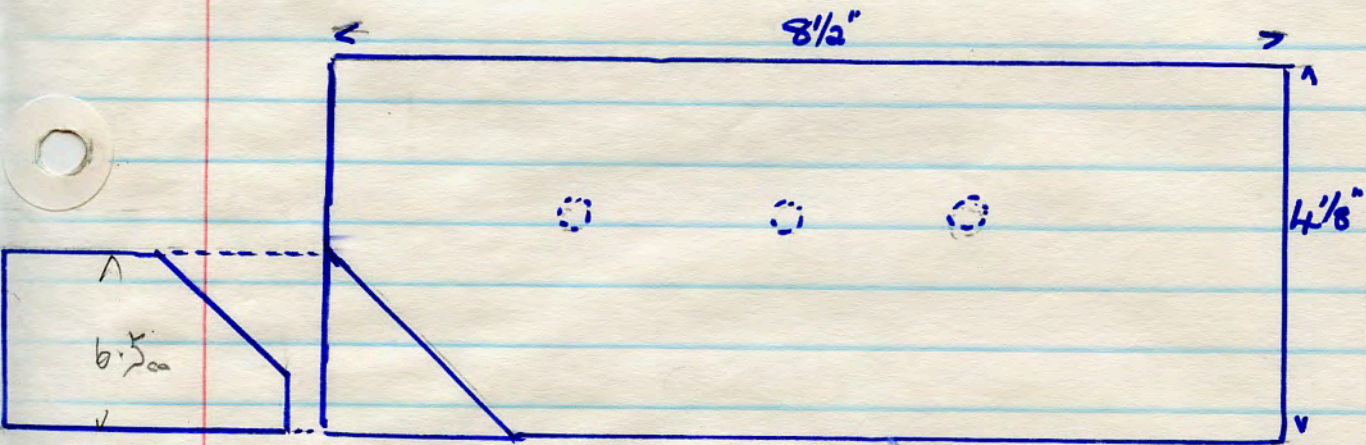

3895

No name. 2511 L red T.C. jamb 7 lbs.
Acc/ton Nori dem. site 30. 10. '88

No name 490C red T.C.
3 lbs.

3896

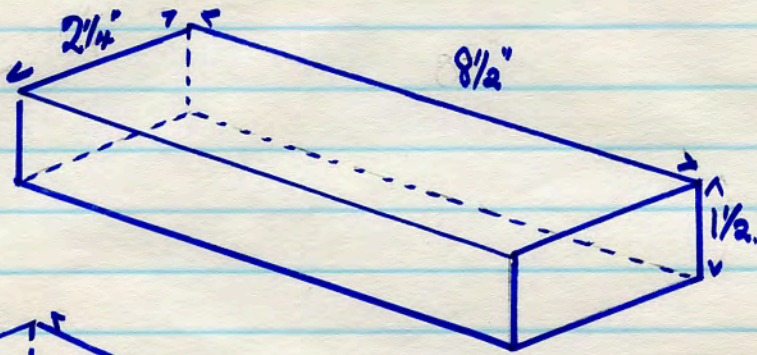

3897

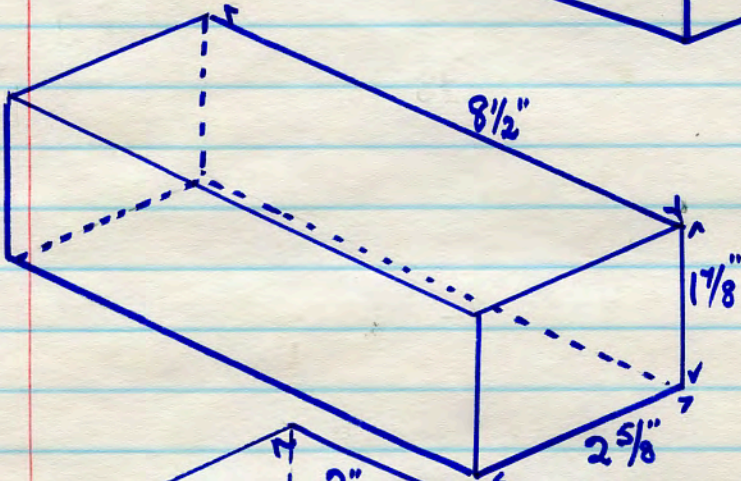

No name. 2814A
red T.C. 5 lbs

3898

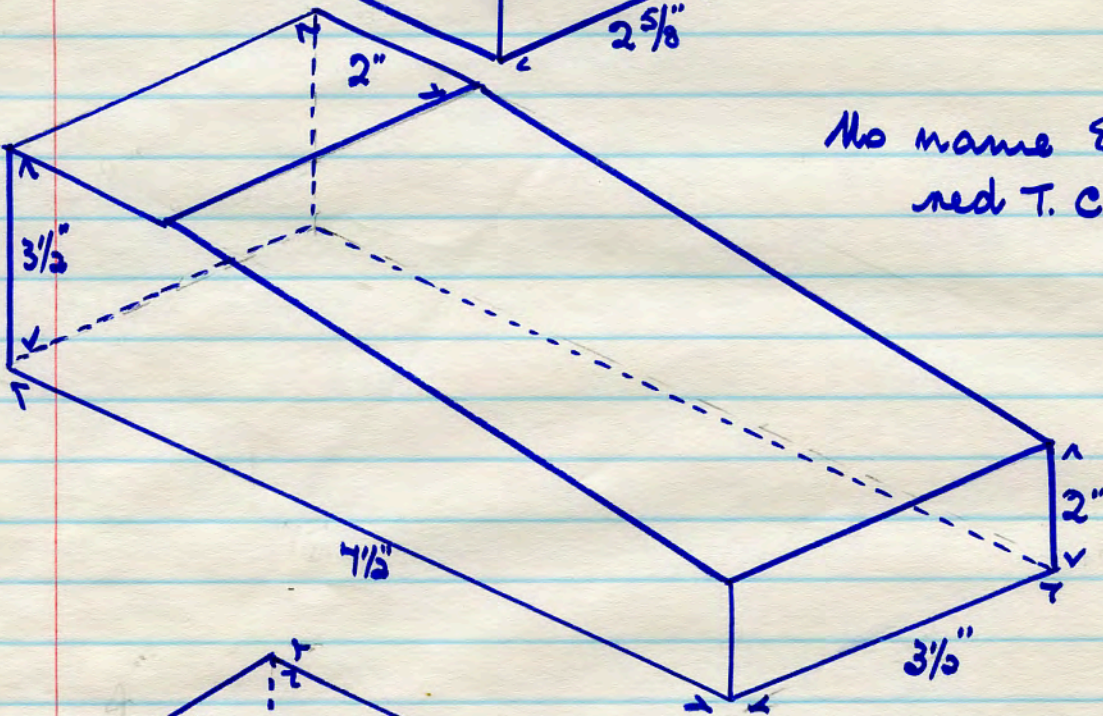

No name 82 9V
red T.C. 8 lbs.

3899

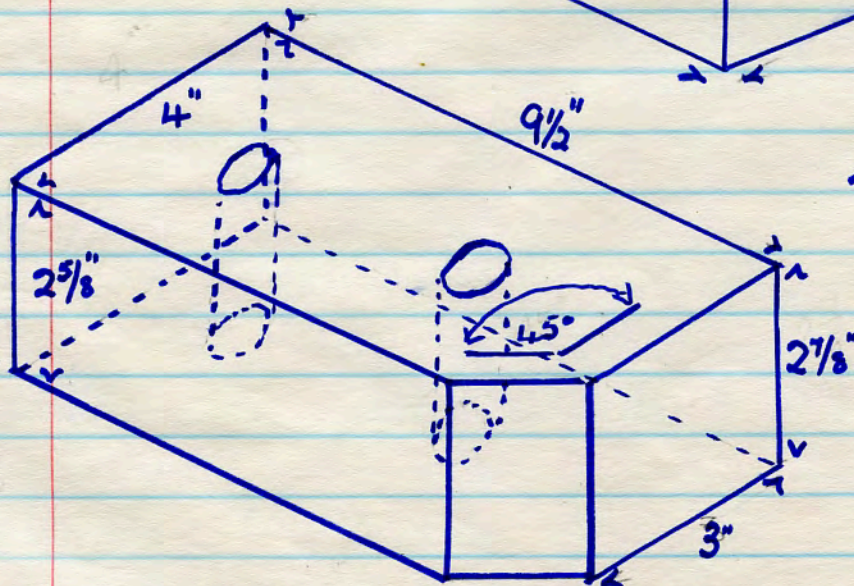

No name 289 V5
tapered. 9 lbs.

All the above from Auction Mori dem. site 30. 10. '88

3900

No name
147 T 7D

dark
brown T.C.

12 1/2 lbs.

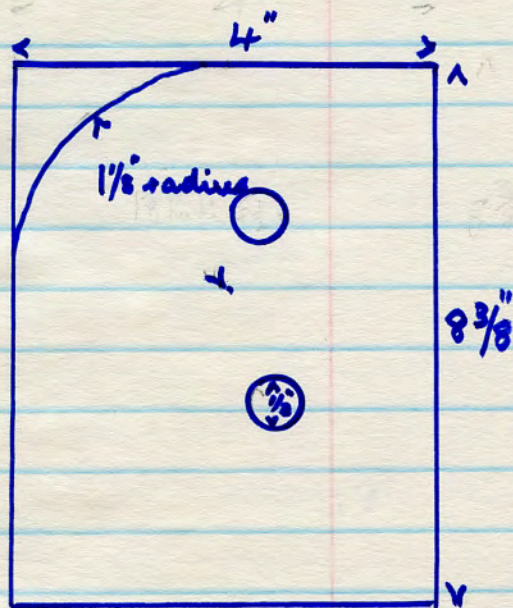
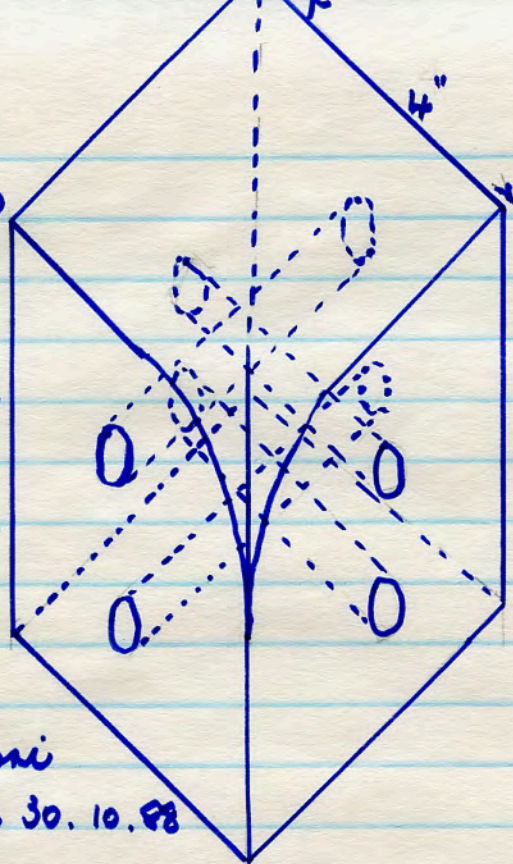

Acclton Mori
dem. site 30. 10. '88

3901

No name
65 C6
red T. C.
14 lbs.

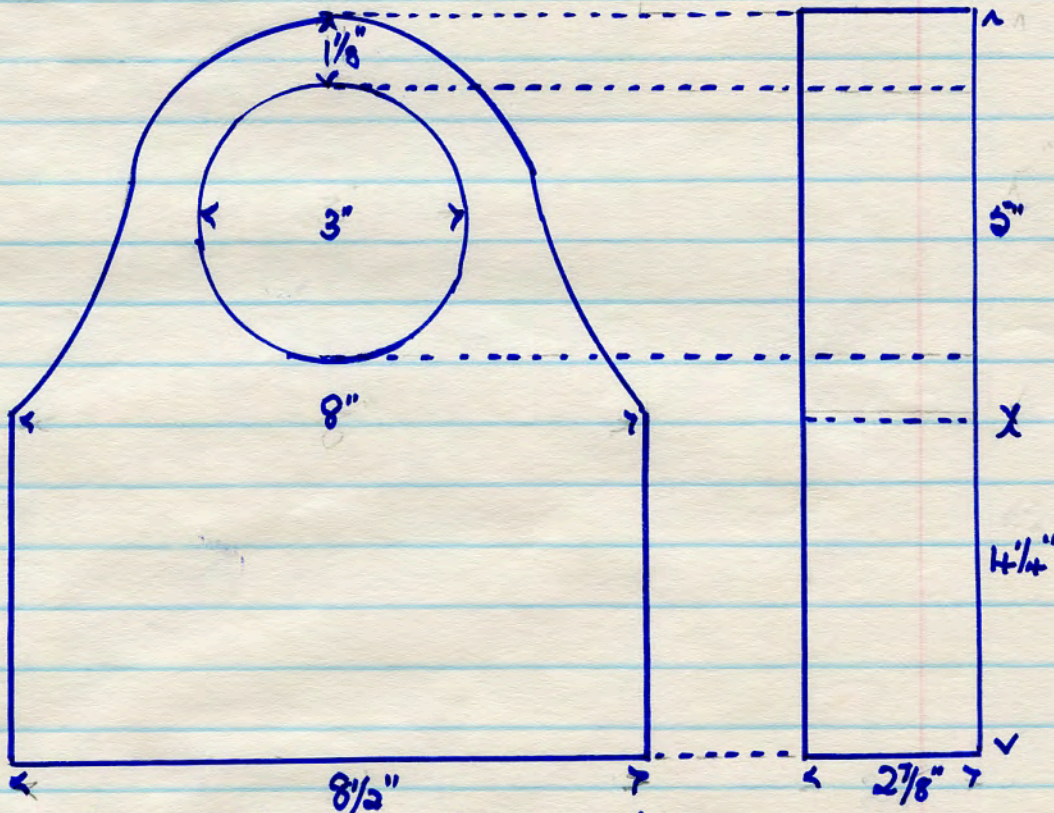

Acclton Mori dem. site. 30. 10. '88

No name 29G 24 scribed red T.C. 8 lbs.
 Acc/ton Hori dem. site 30. 10. 88.

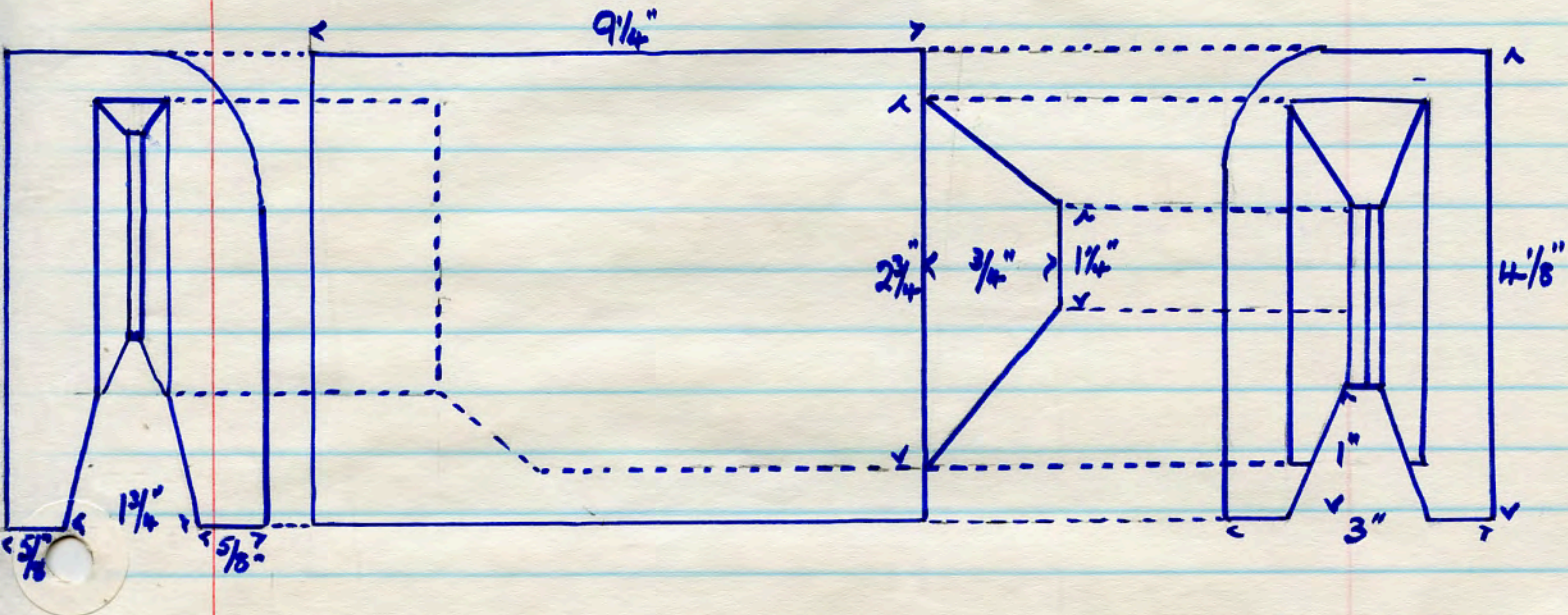

3902

PLAN

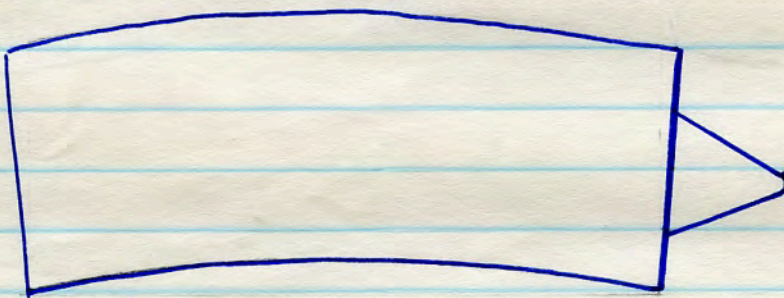

No name 23162 red T.C. full hull nose. 7 lbs.
 $8 \frac{3}{8}'' \times 4'' \times 2 \frac{5}{8}''$.

3903

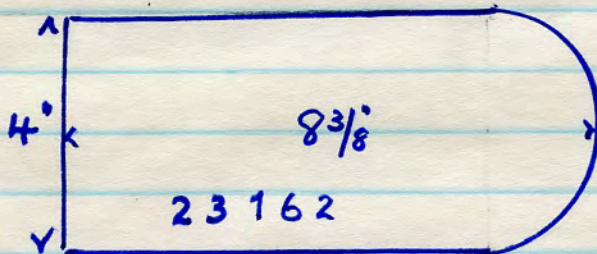

Specifications as 3903 with the addition of 2 x 1" diam
 perfs.

3904

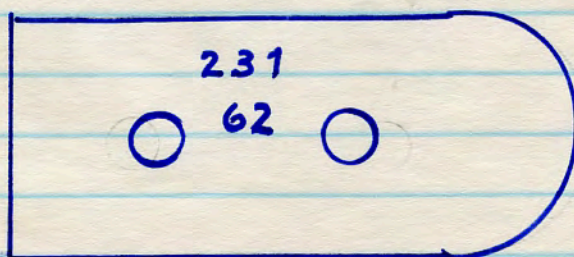

Acc/ton Hori dem. site 30. 10. '88

no name. no number. no panels. red T.C.
7 lbs.

3905

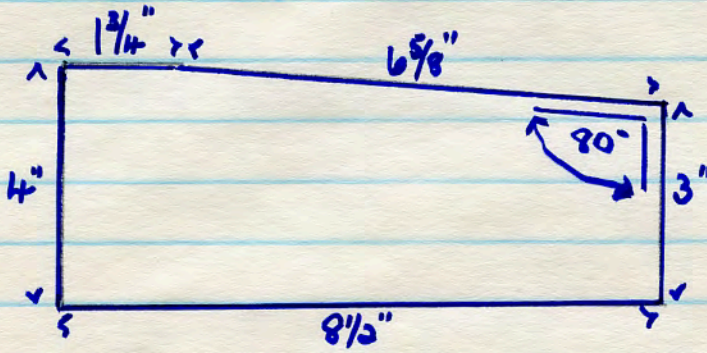

Acc/ton Hori dem. site 30. 10. '88

no name 351 T5 red T.C. wall cap 10 lbs

3906

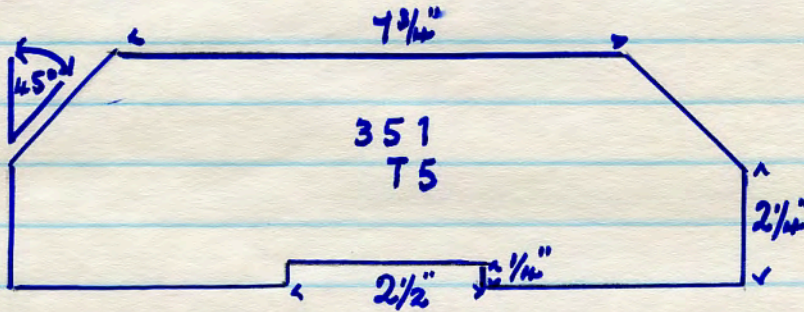

Acc/ton Hori dem. site 30. 10. '88

3907

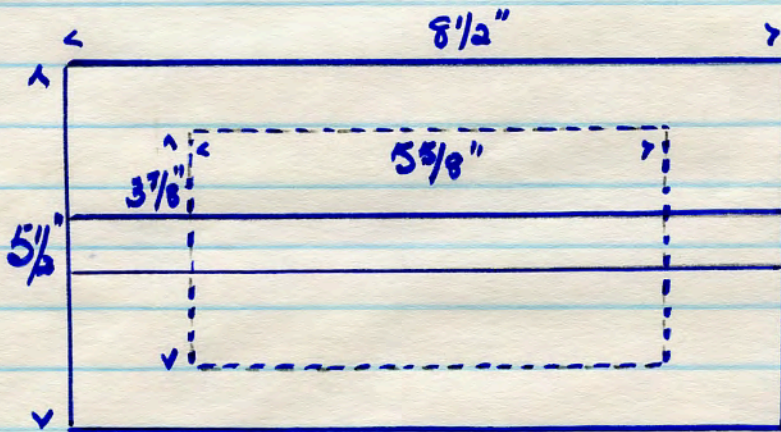

no name 169T9
red T.C.
groove $5/8" \times 3/8"$
full length of brts.
overall depth 4"
cavity in base
 $1 7/8"$ deep.

Acc/ton Hori dem. site. 30. 10. '88

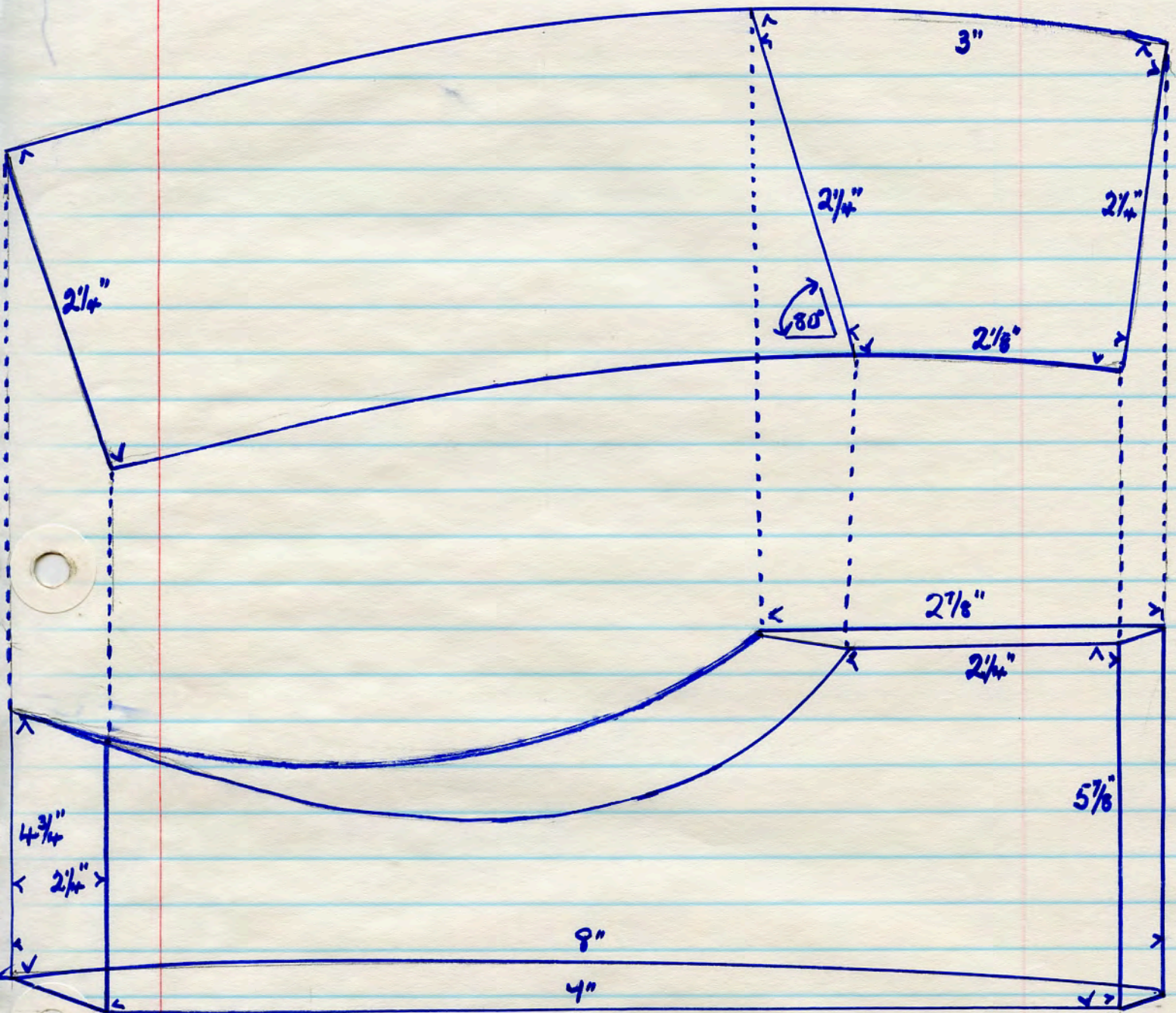

No name. 27G118 red T.C.
 maker's initial T. 7 lbs.
 Acc/ton Mori dem. site # 30. 10. '88

3908

No name. no number. small red T.C. floor tile
 1" thick. (patio)
 Top.

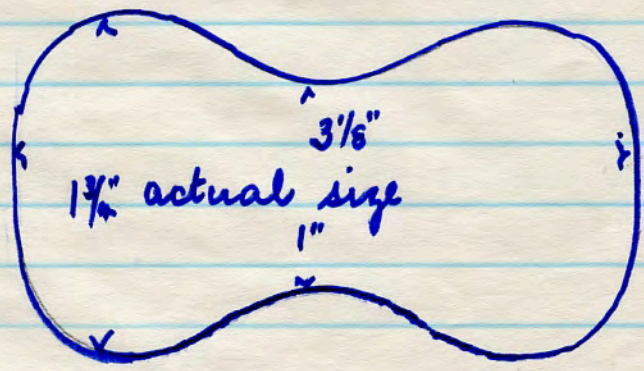

Acc/ton Mori dem. site
 8. 11. 88.

3909

3910

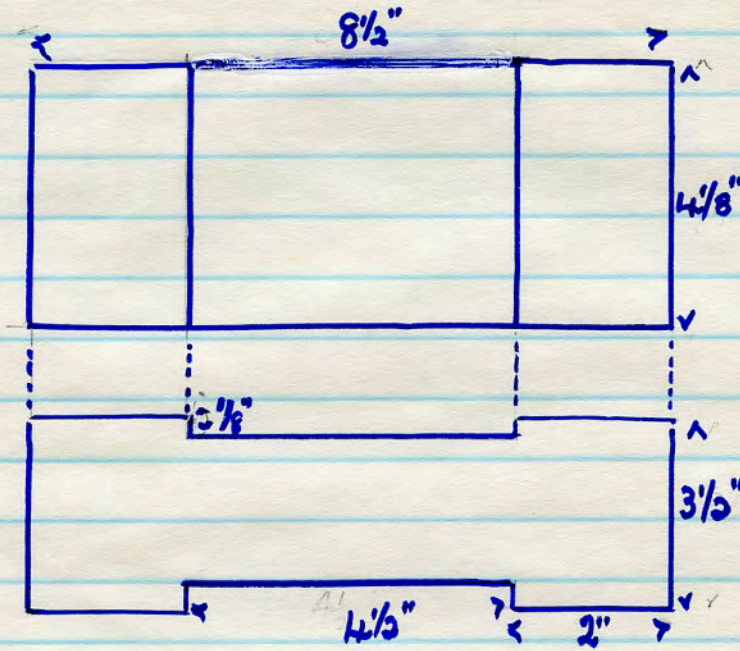

No name
no number.

red T.C.

11 lbs.

3911

No name 323 T. red T.C. 8 lbs

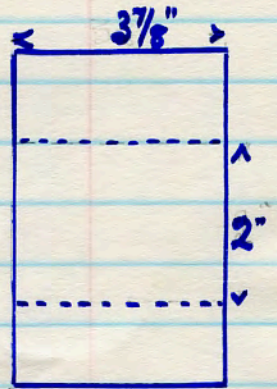
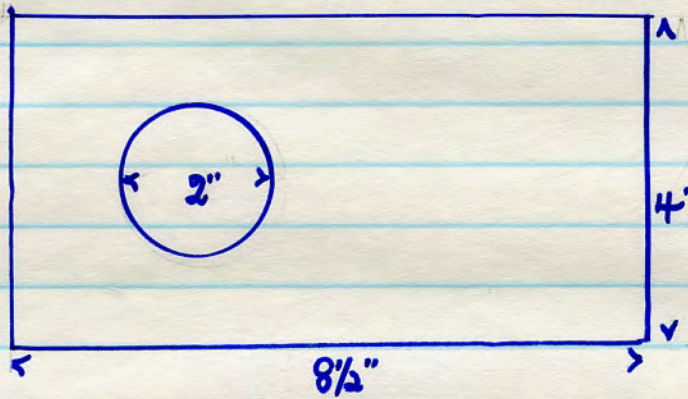

3912

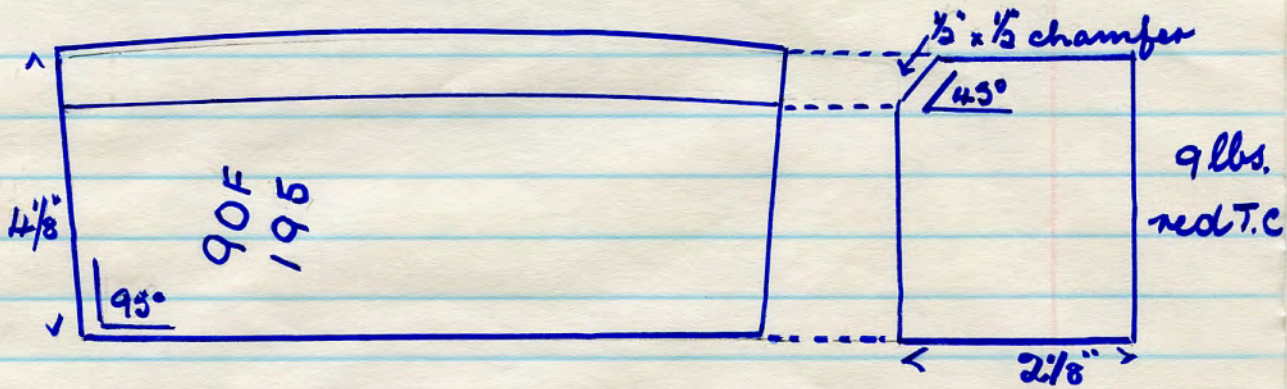

3913

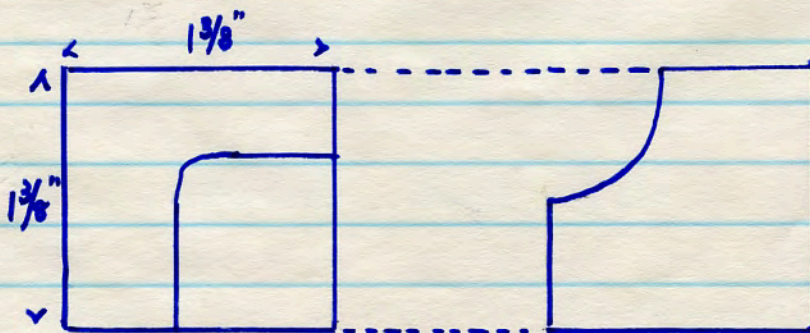

No name

PL100

red T.C.

2 lbs.

All the above from Acso/ton Mori dem. site 30. 10. 88

No name 284 T18 red T.C. 10 lbs.

3914

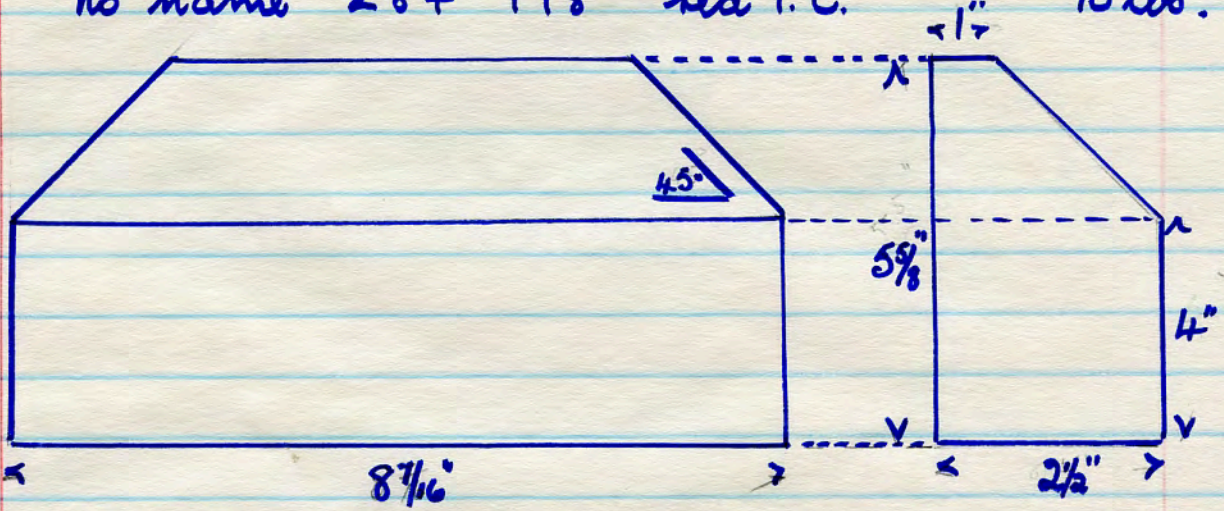

No name 756 VL red T.C. 8 lbs.

3915

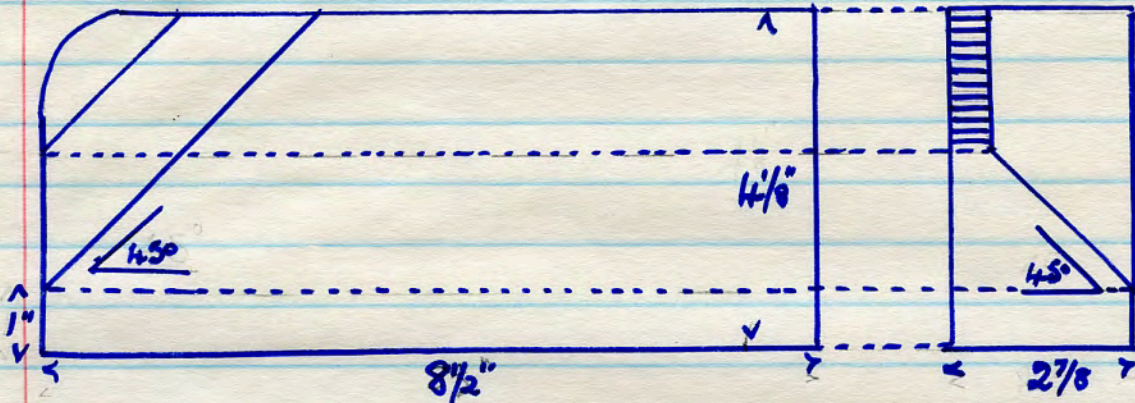

No name 14R CA8 red T.C. 7 lbs

3916

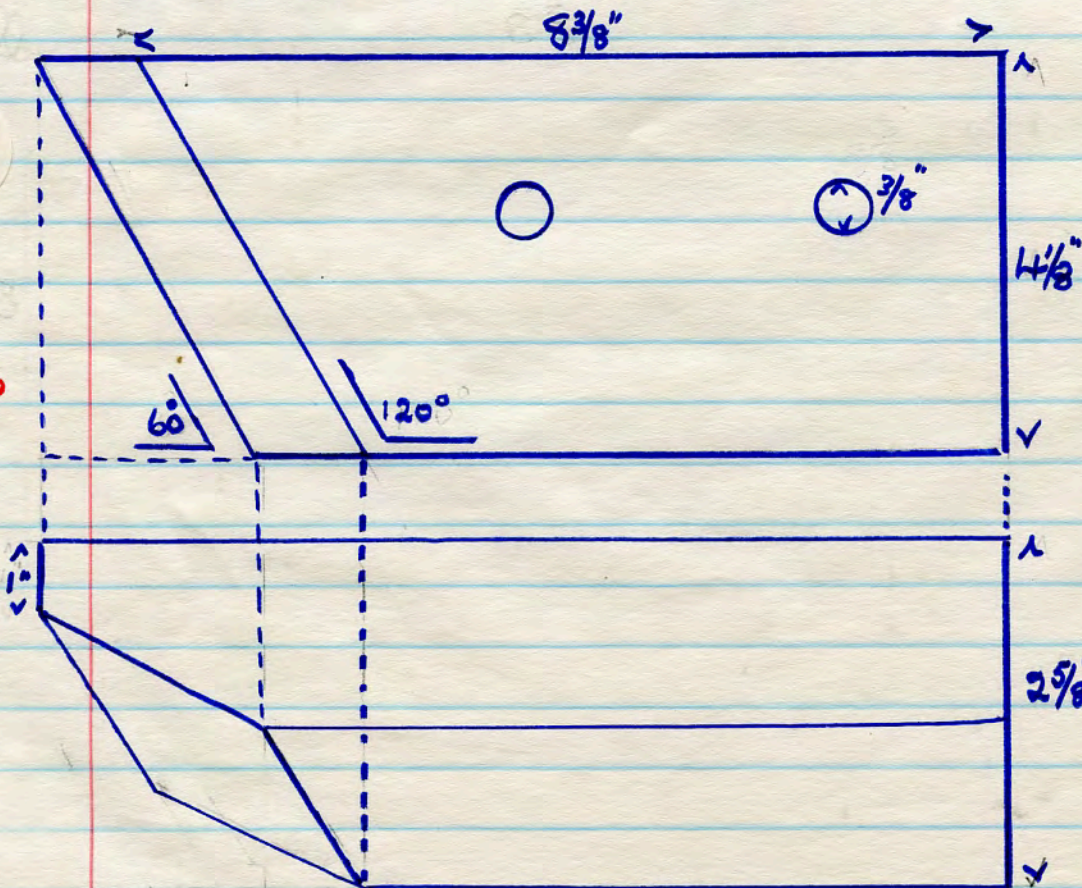

All the above
are from
Acclon Mori
dem. site
30. 10. '88

3917

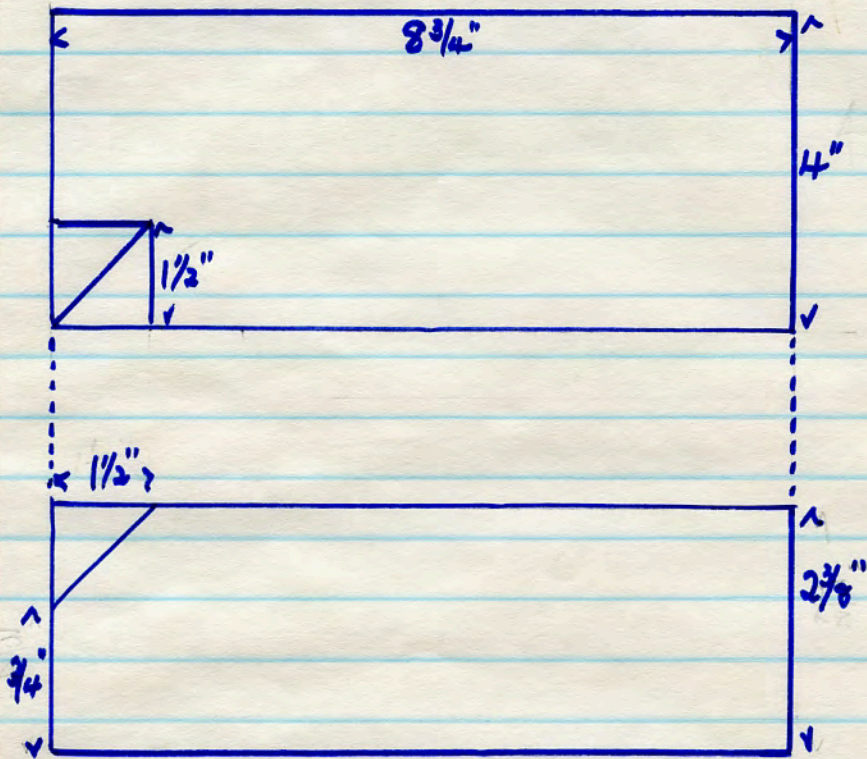

no name
2552 L

red T.C.

7 lbs.

3918

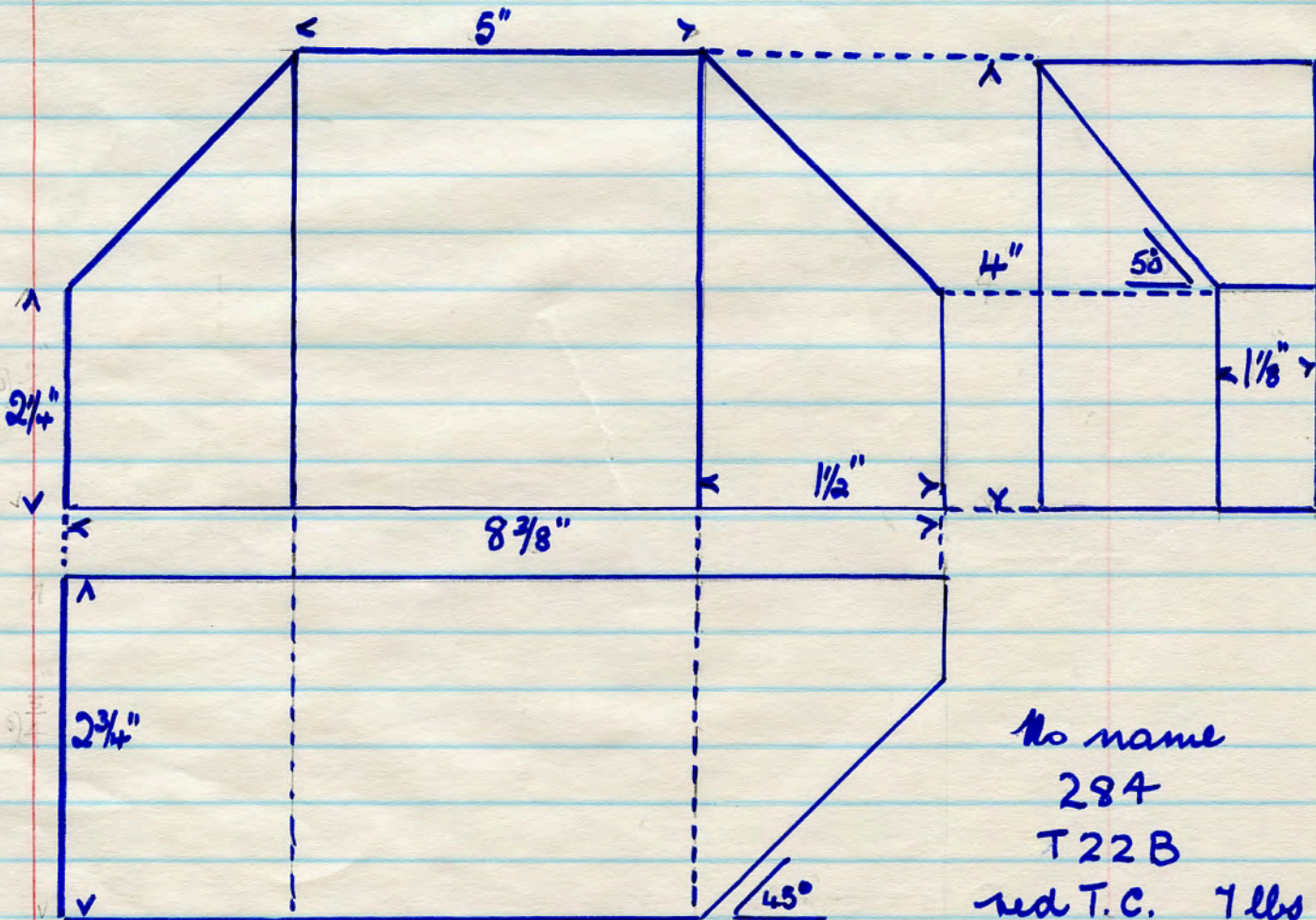

no name
284
T22B
red T.C. 7 lbs

Both the above from Acc/ton Mori dem. site 30. 10. '88

3919

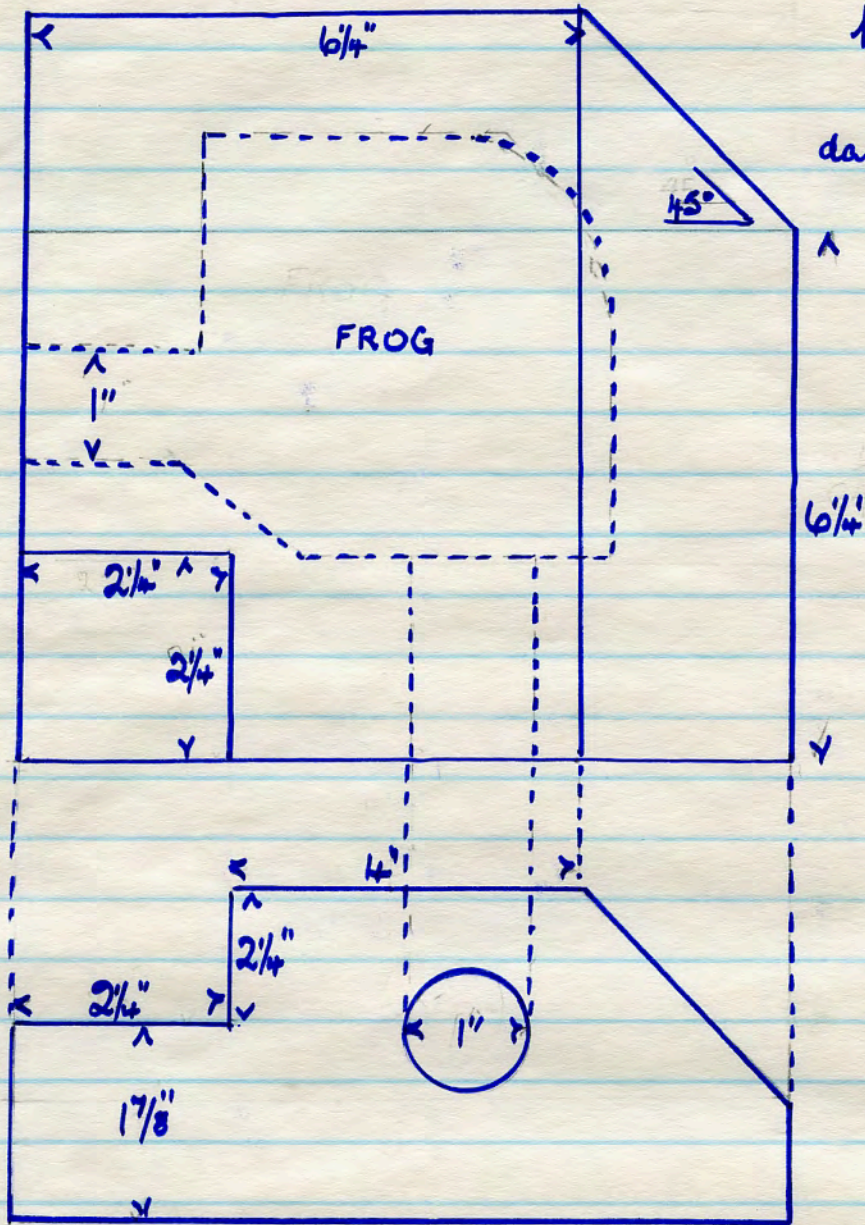

No name

133 T2.

dark brown T.C.

16 lbs.

3920

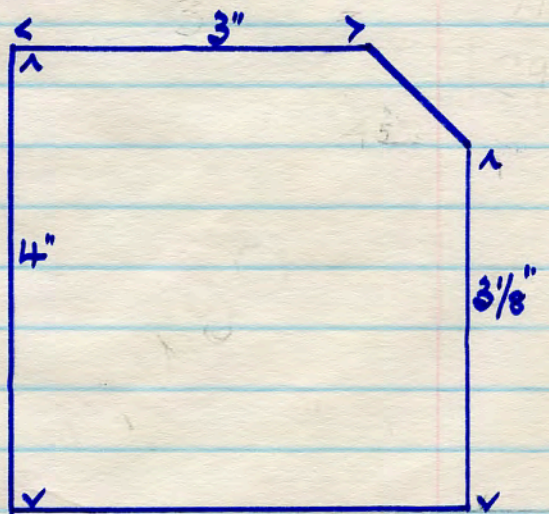

3921

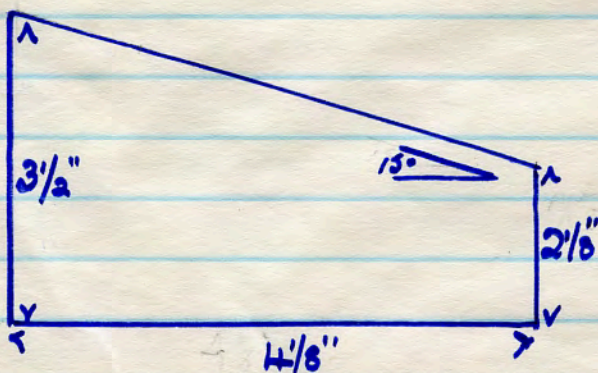

No name. 19 K U 12
 red T.C. 2 1/2 lbs.
 2" thick.

No name. 87 U 90
 red T.C. 4 lbs
 2 7/8" thick

All the above from Accpton Hori dem. site 30. 10. '88

3922

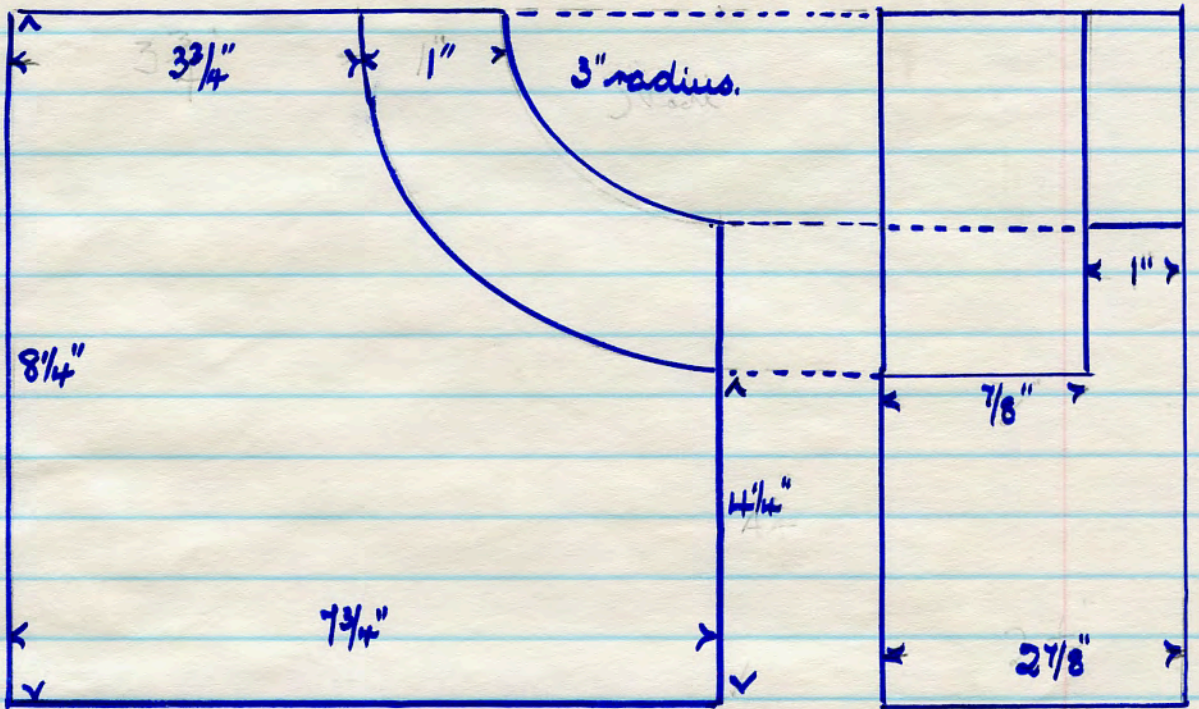

No name. 215 TA
 red T.C. 14 lbs.

3923

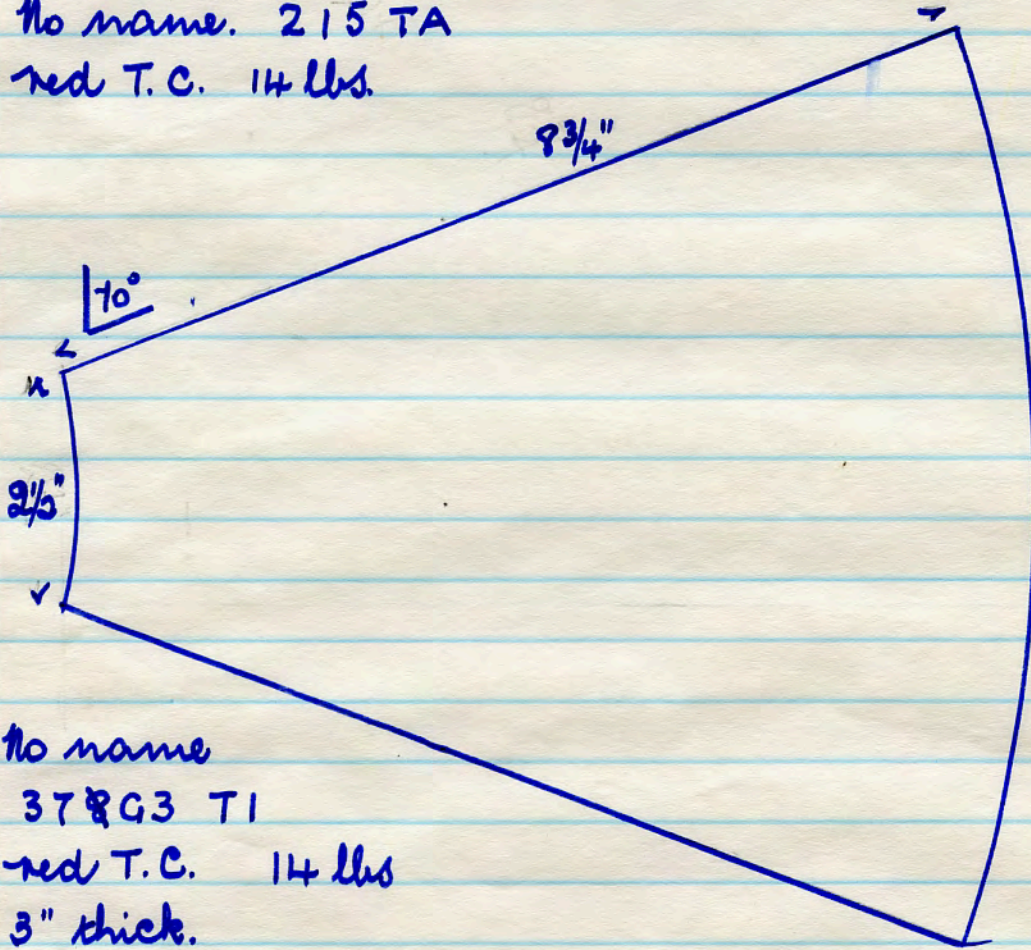

No name
 37 & G3 T1
 red T.C. 14 lbs
 3" thick.

3924

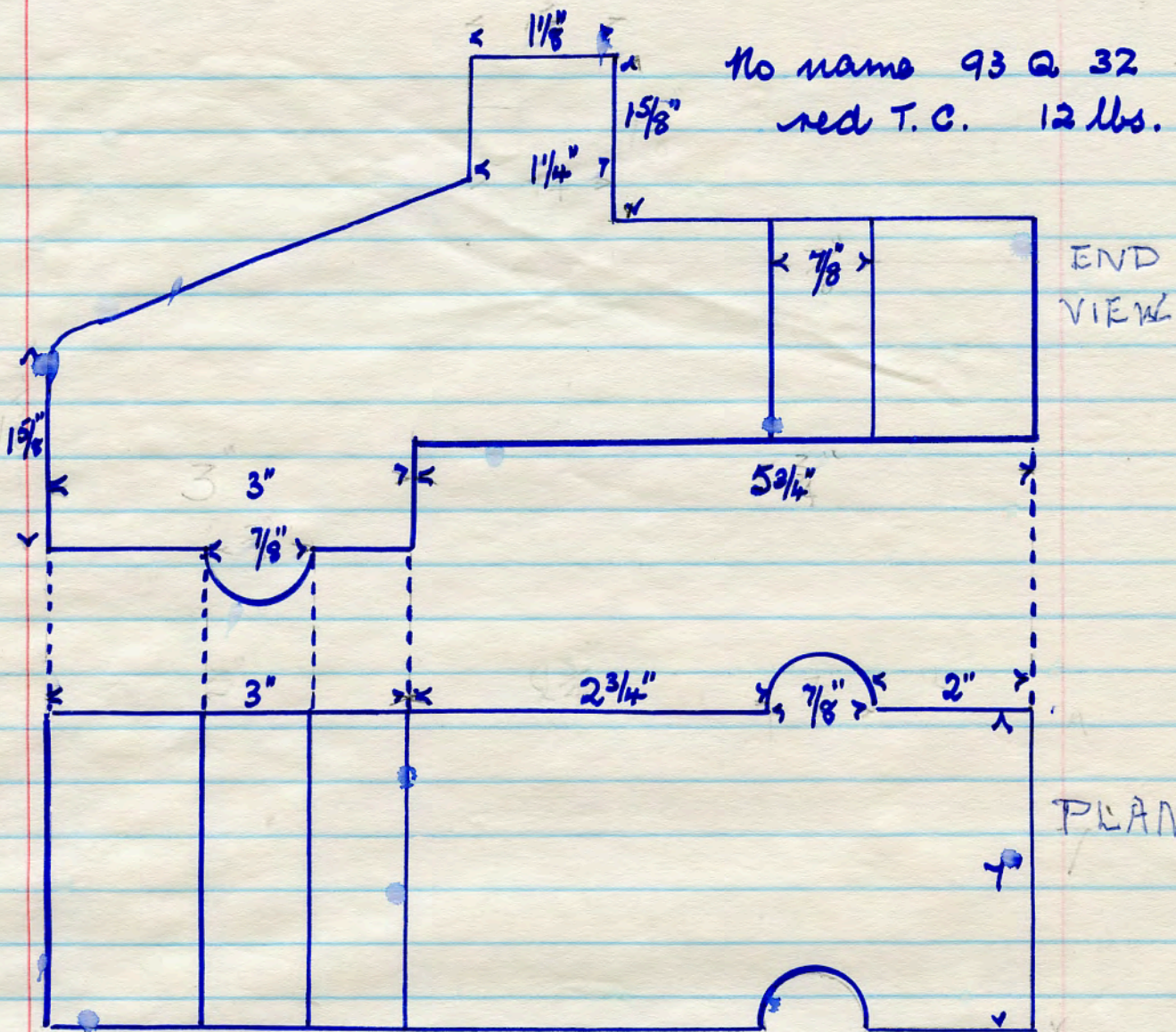

No name 93 Q 32
red T.C. 12 lbs.

3925

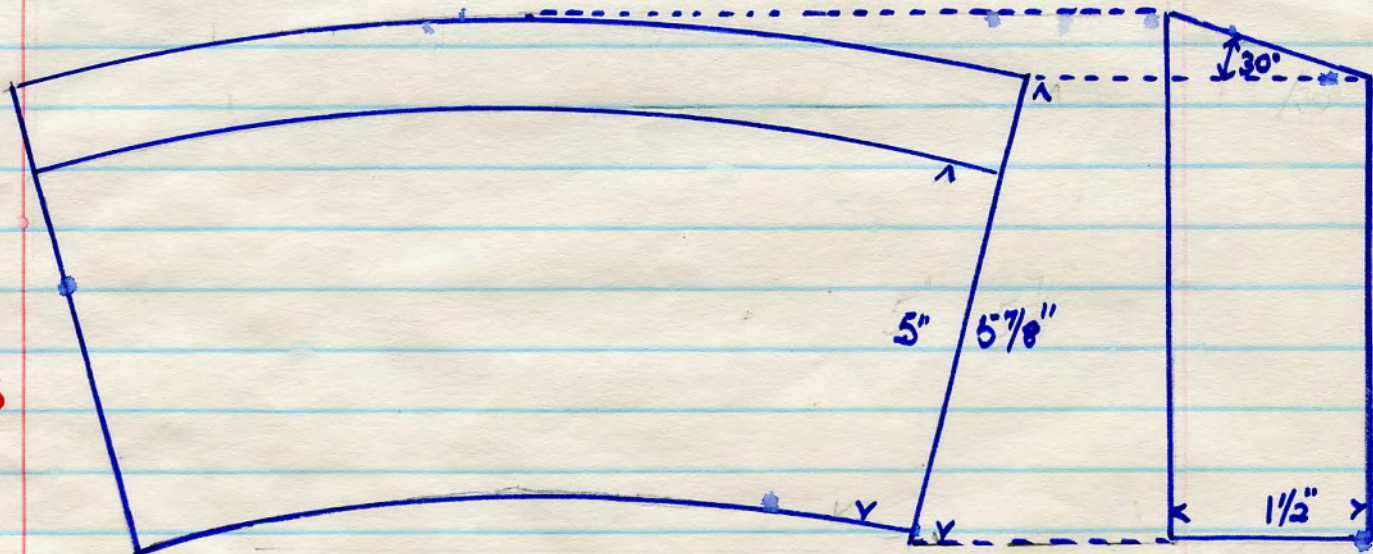

No name. 99 P 2 red T.C 4 lbs.

3926

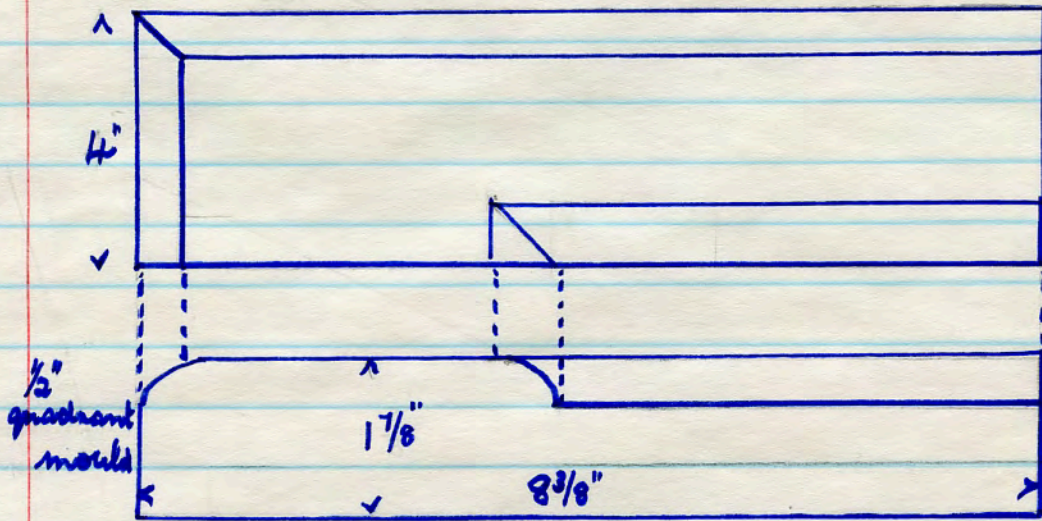

no name
 P2XR
 red T.C
 floor tile
 edging and
 return.
 6 lbs
 right hand
 to 3832.

Acc/ton Mori dem. site. 11. 11. 88.

3927

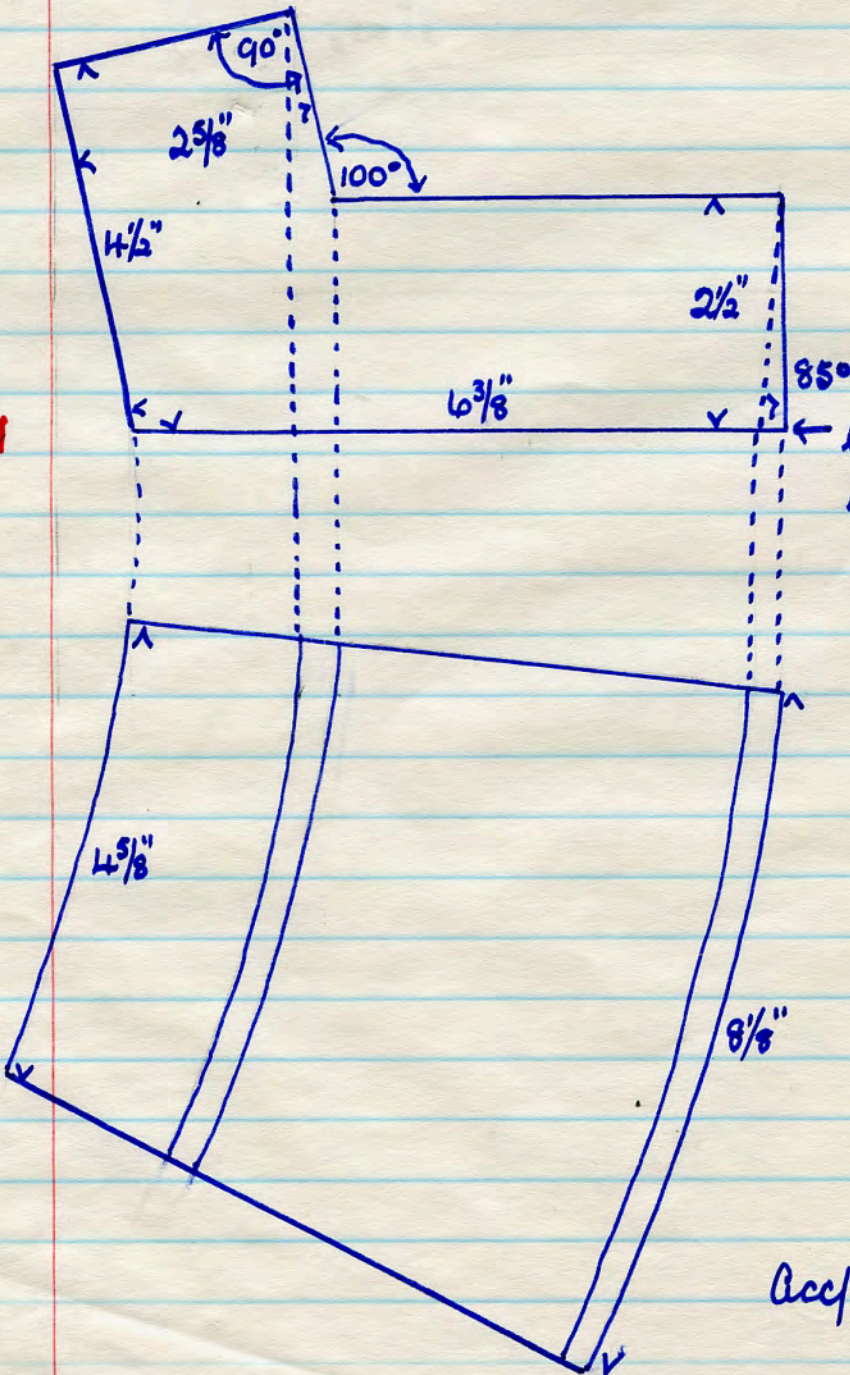

no name 37 P 15
 red T.C. scribed.
 11 lbs.

← this surface is dished
 to assist in the flow
 of fluid.

Acc/ton Mori dem. site
 30. 10. 88.

All bricks from Accton Noni dem. site 11. 11. '88

No name. 18 2 T red T.C. plinth brick.

7 lbs.

rusted surface on 2 ends & 2 faces, 1 edge.

3928

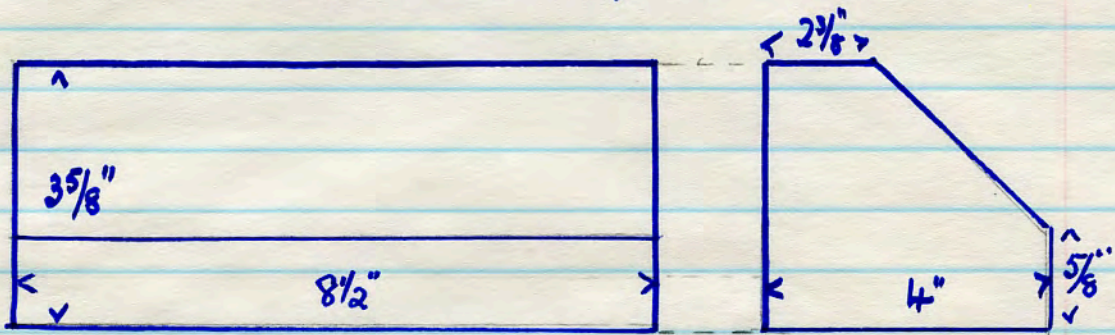

No name 25 9T red T.C. 5 lbs.

3929

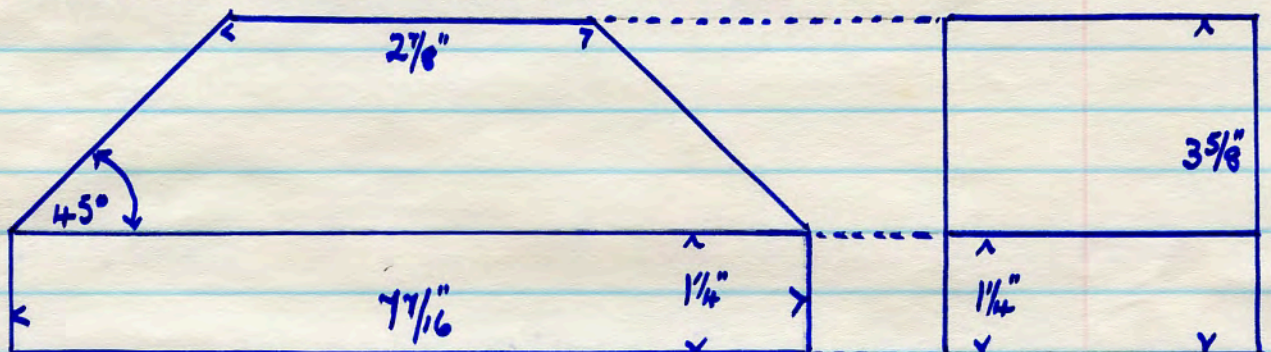

3930

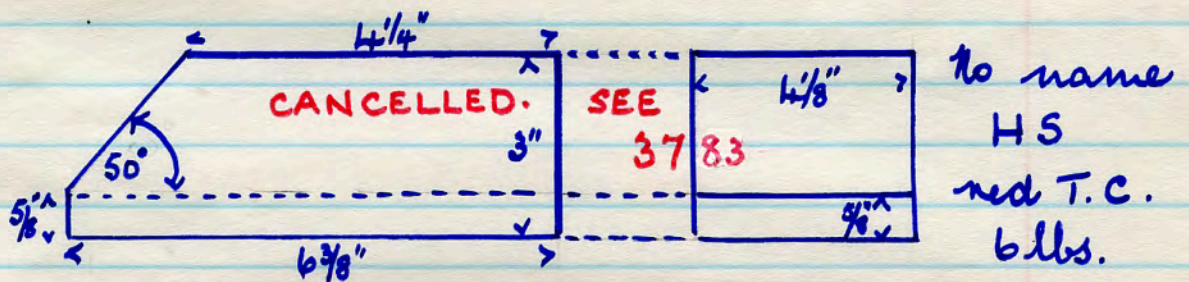

3931

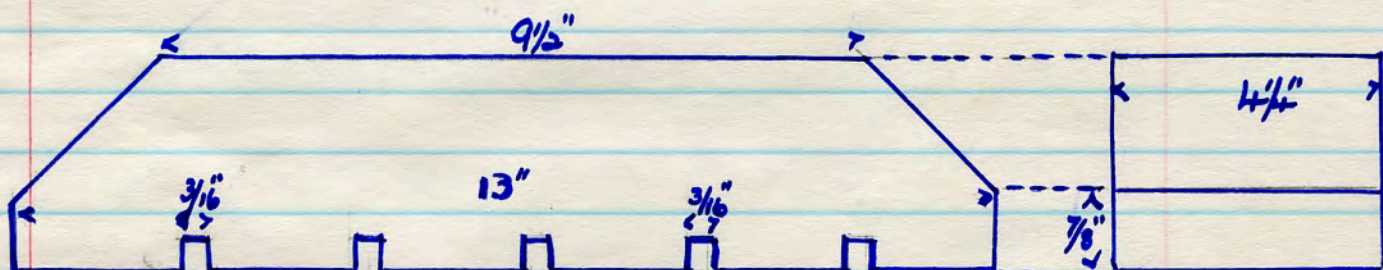

No name. 334 TA red T.C. $11\frac{1}{2}$ lbs.

3932

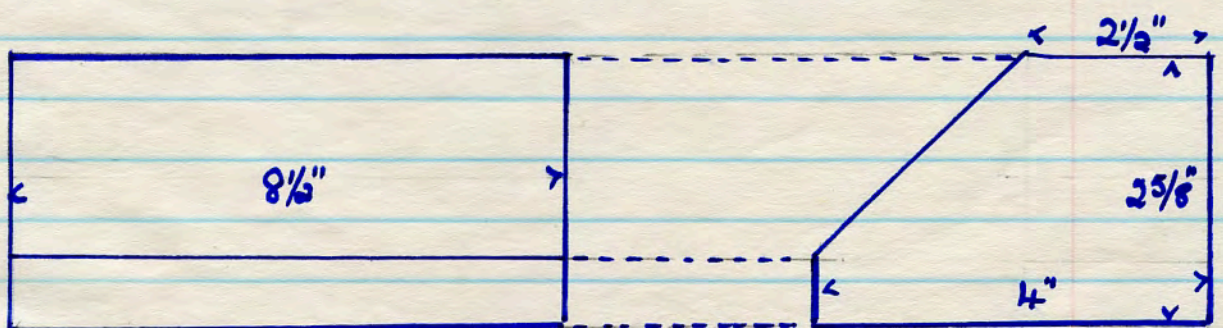

No name 2532J stamped. red T.C. 7 lbs.

No name 998 V 8 red T.C. plinth 13 lbs.

3933

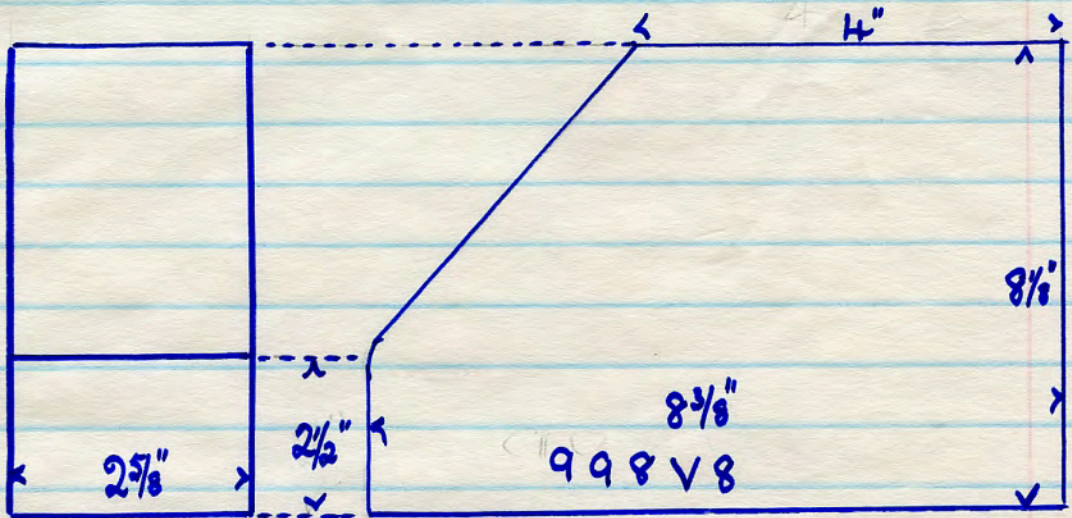

No name K15 red T.C. plinth 8 lbs.

3934

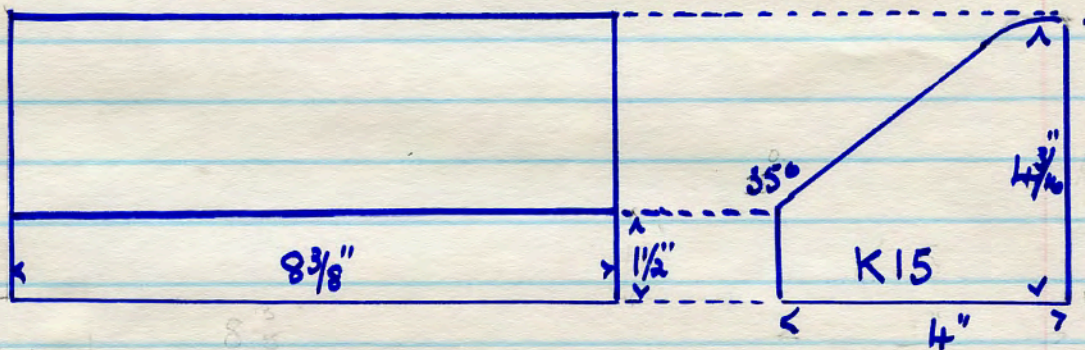

No name 2572 RD dark brown T.C. 6 1/2 lbs.

3935

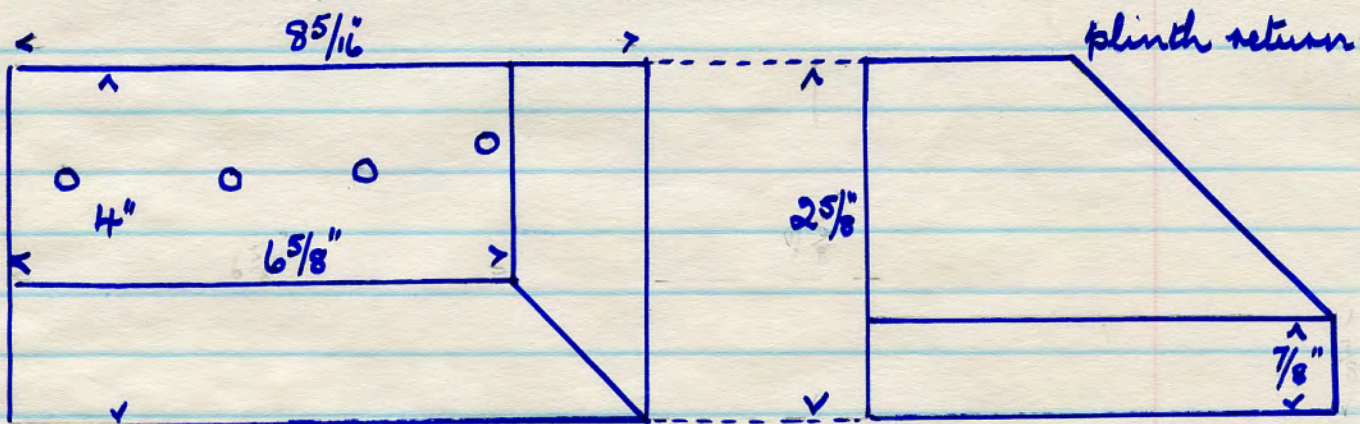

All the above are from Acc/ton Hosi dem. site 11. 11. '88

No name 314 T.B. red T.C. 18 lbs.

3936

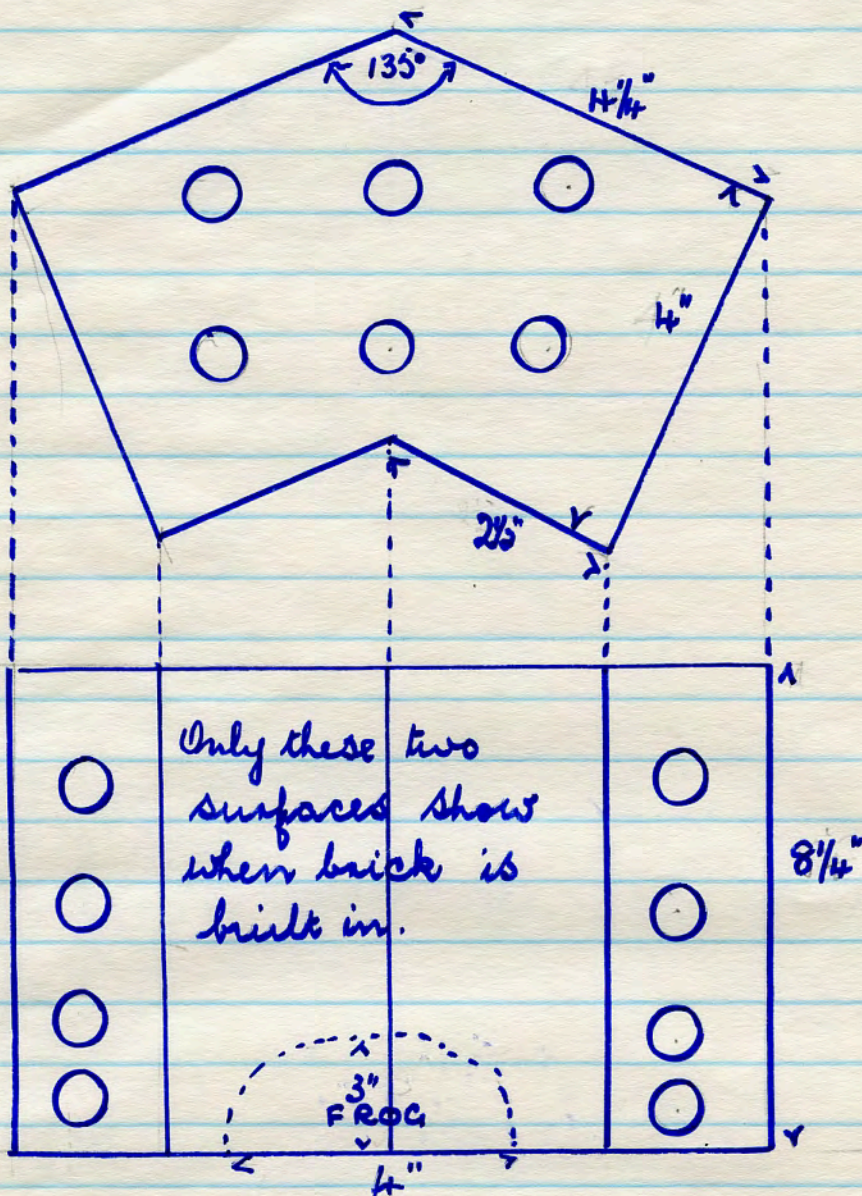

No name. no number. dark brown T.C. 3 lbs

3937.

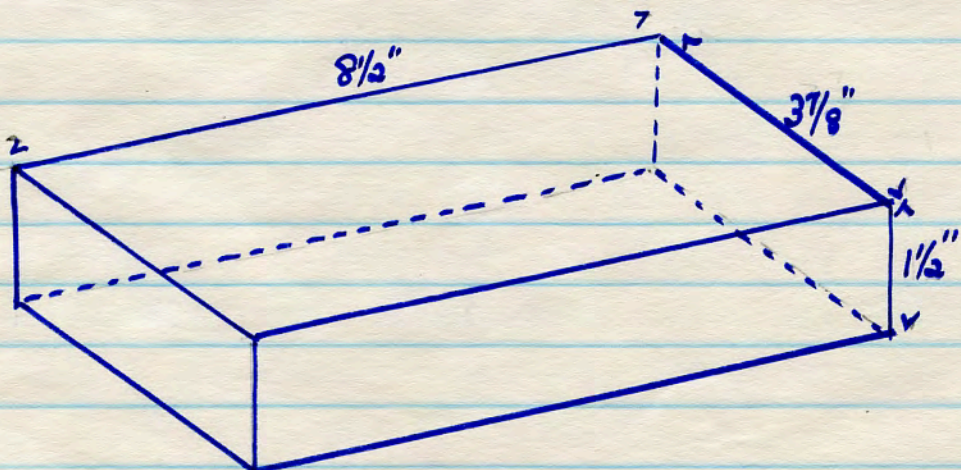

3938

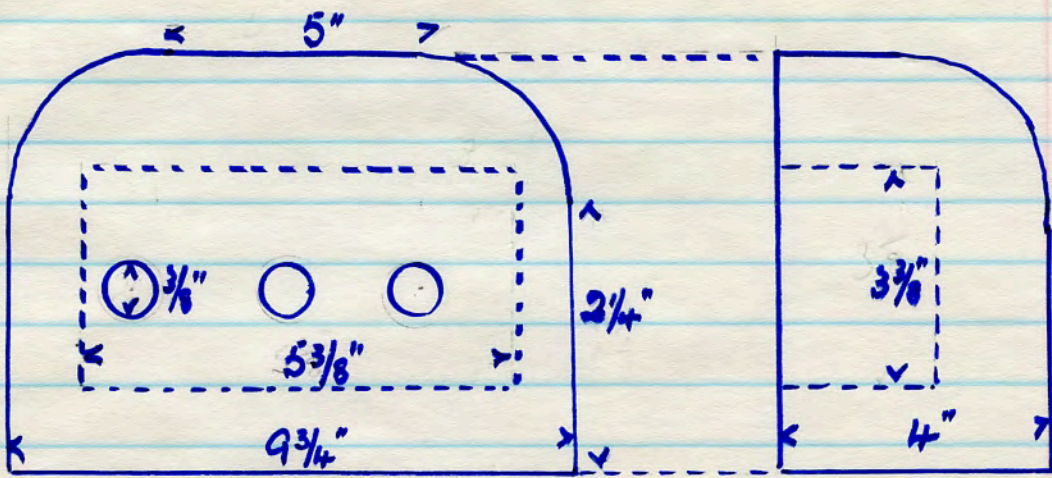

No name. 23152 D. dark brown T.C. 14 lbs
bullnose return

3939

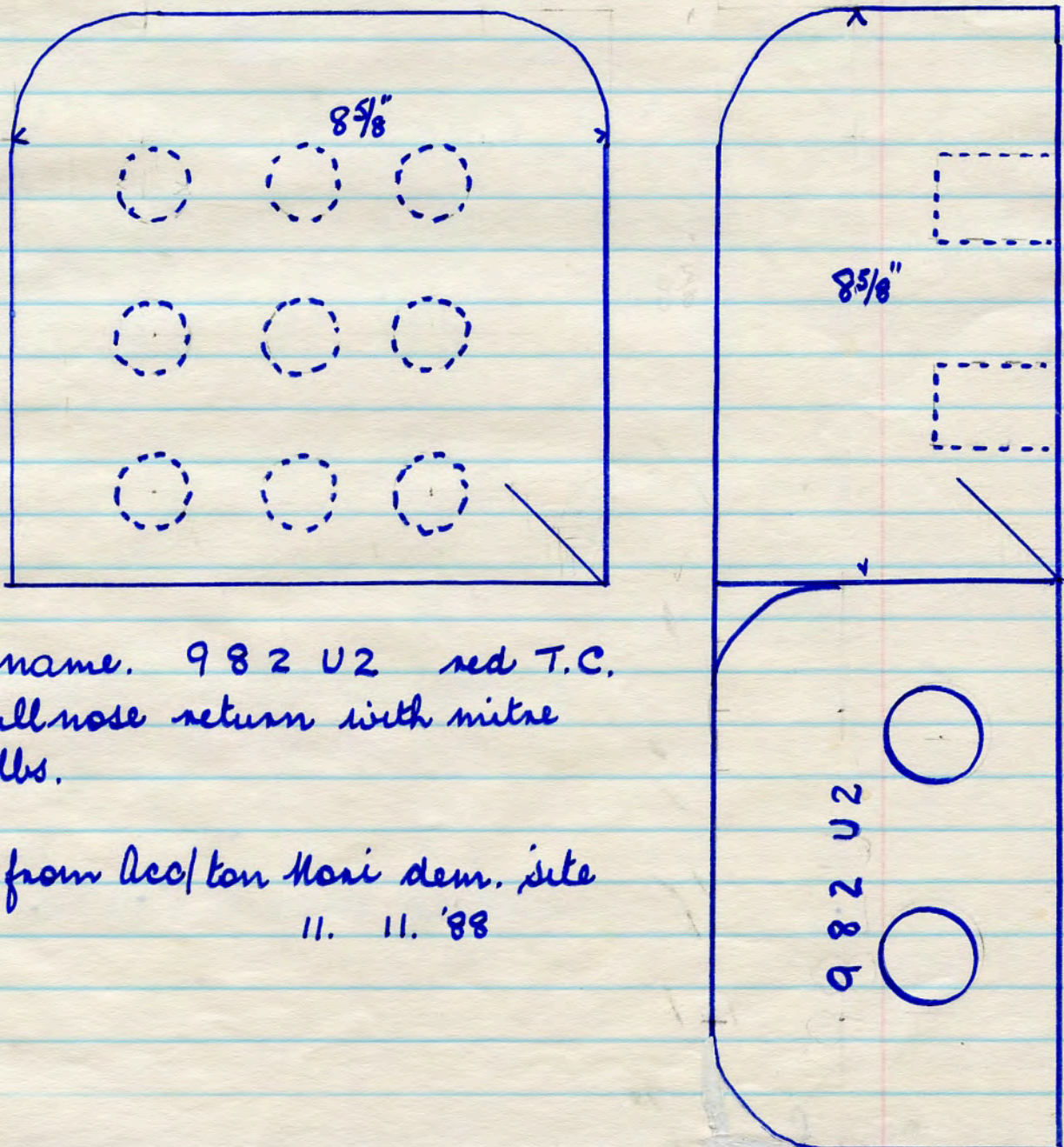

No name. 982 U2 red T.C.
bullnose return with mitre
21 lbs.

Both from Acc/ton Mori dem. site
11. 11. '88

982 U2

No name 61 9V

light brown

7 lbs.

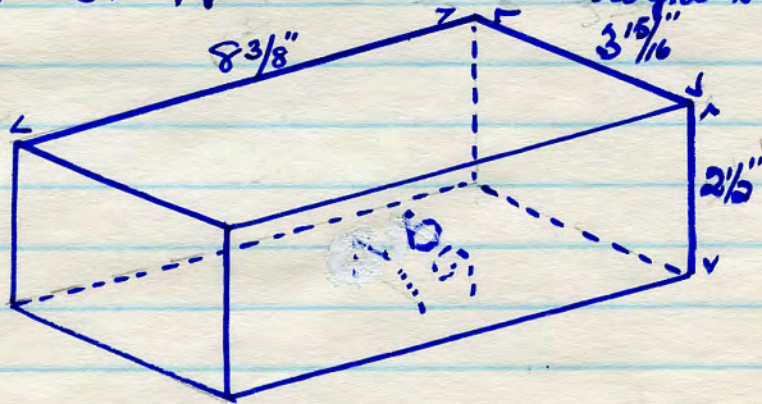

3940

base & 1 edge are plain, rest of brick rustic finish
Acpton Mori dem. site. 12. 11. 88.

No name. C E G B red T.C 7 lbs.

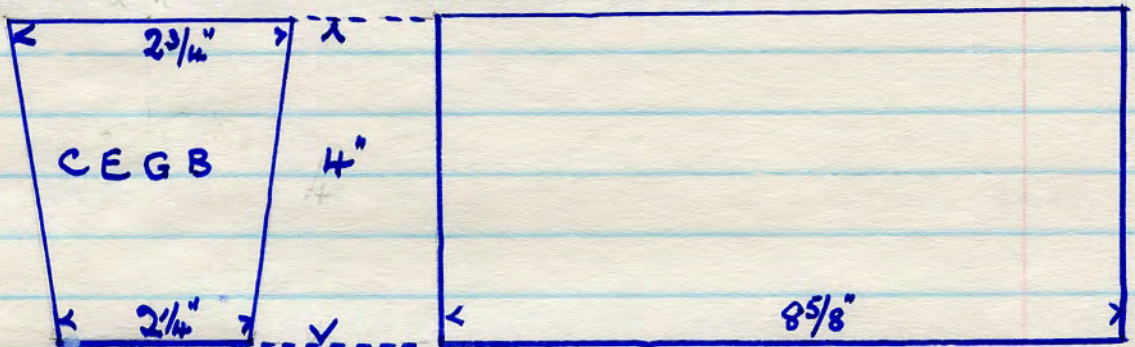

3941

dressed face edge

No name.

dark brown T.C. 5 lbs.

3942

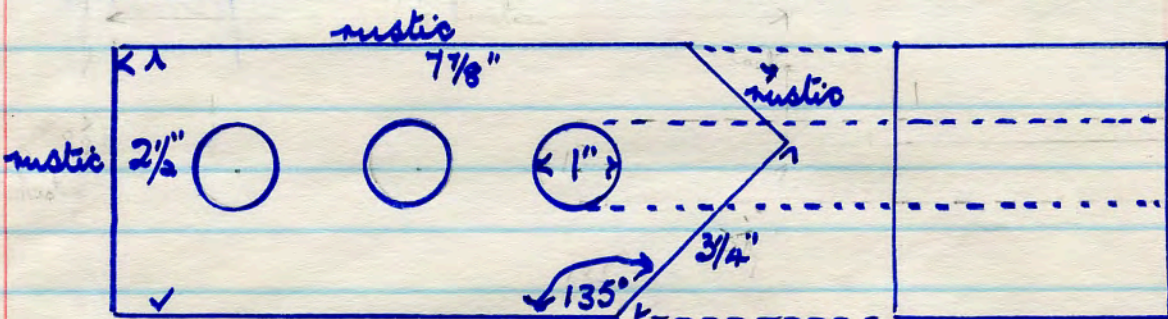

No name.

dark brown T.C. ventilator brick.

2 1/2 lbs.

3943

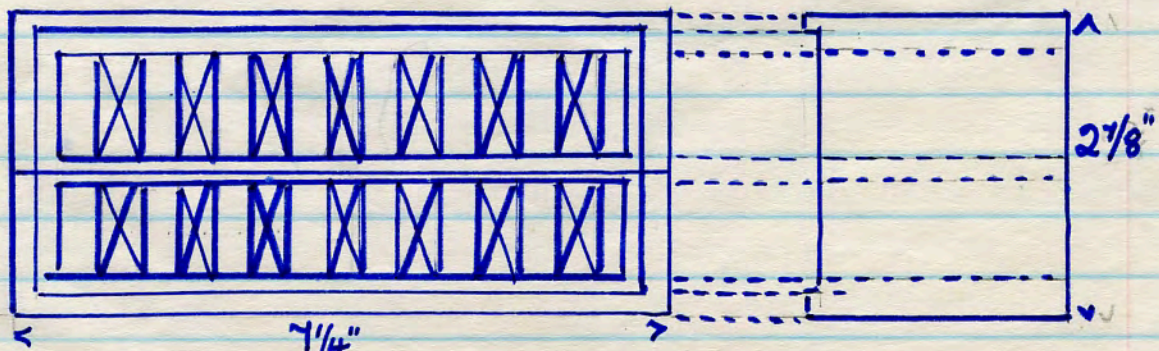

3944

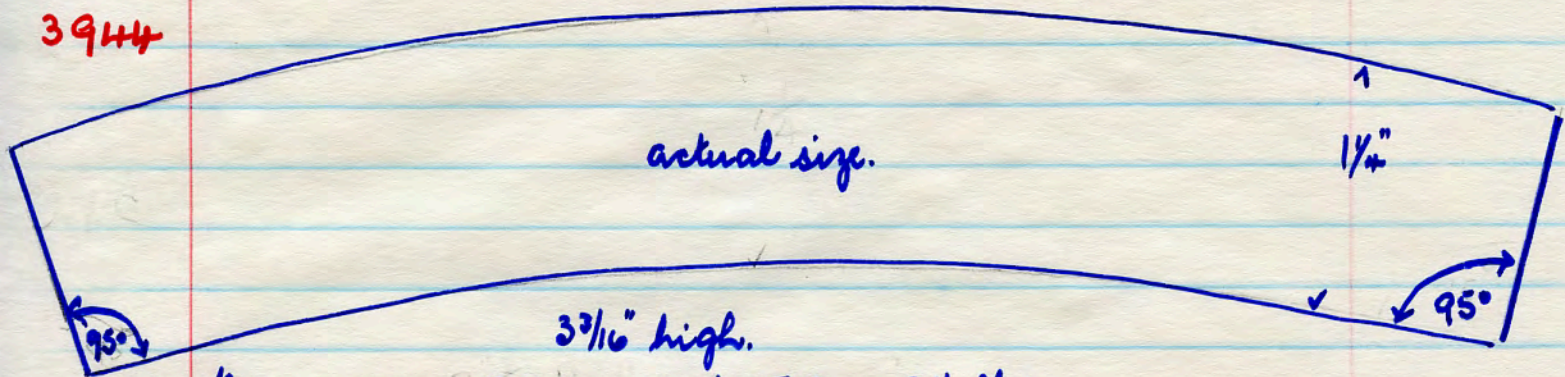

no name. OTC red T.C. 2 1/2 lbs.

no name. PL 81 red T.C. 6 lbs.

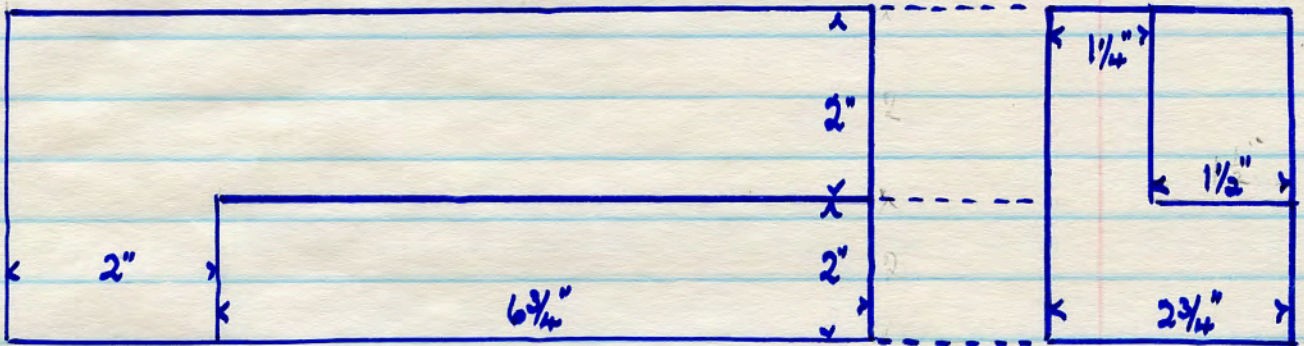

3945

no name RL 80 red T.C. 8 1/2 lbs.

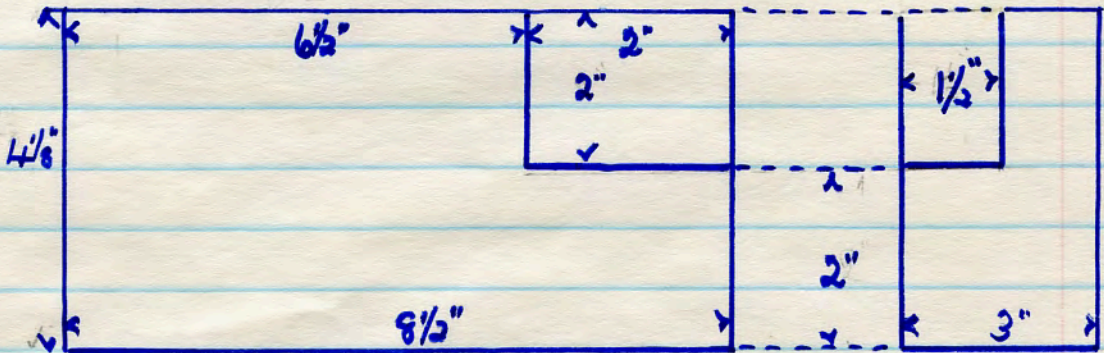

3946

no name. 66 TU. red T.C. 9 lbs.

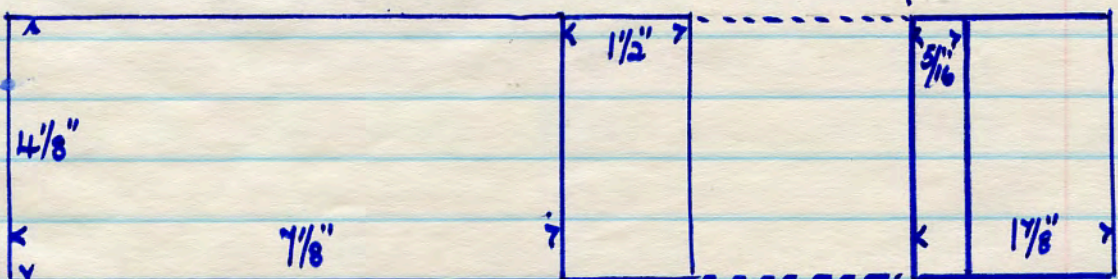

3947

All above from Acepton Hoar dem. site

ACCRINGTON NORI stamped down back several times 22 lbs. red TC

3948

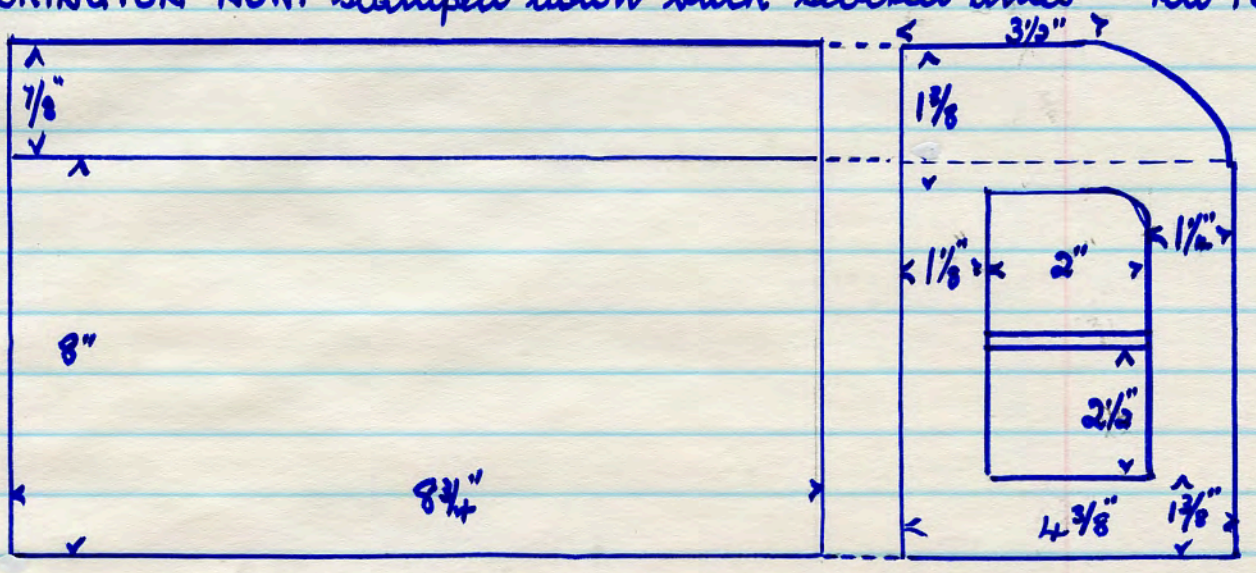

No name 245 1VX red T.C. 12 lbs.

3949

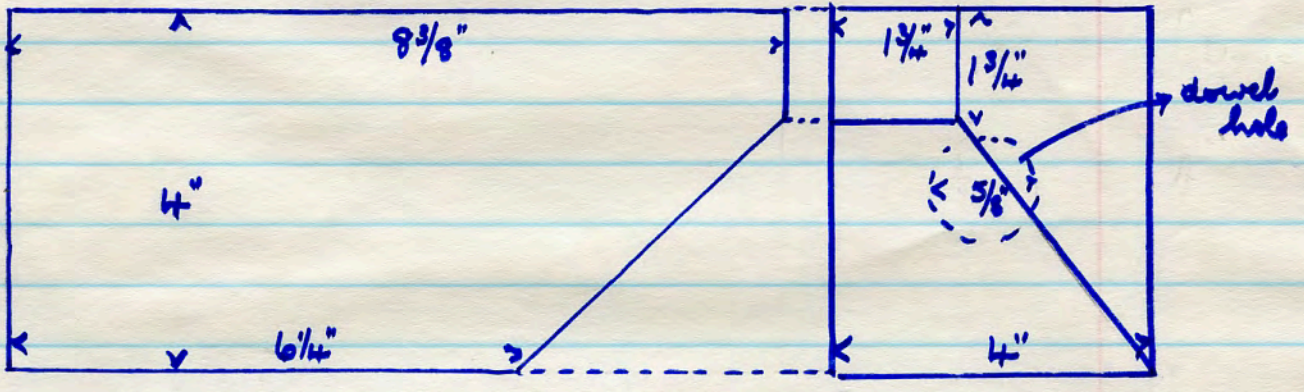

No name 284 T 24A red T.C. 16 lbs

3950

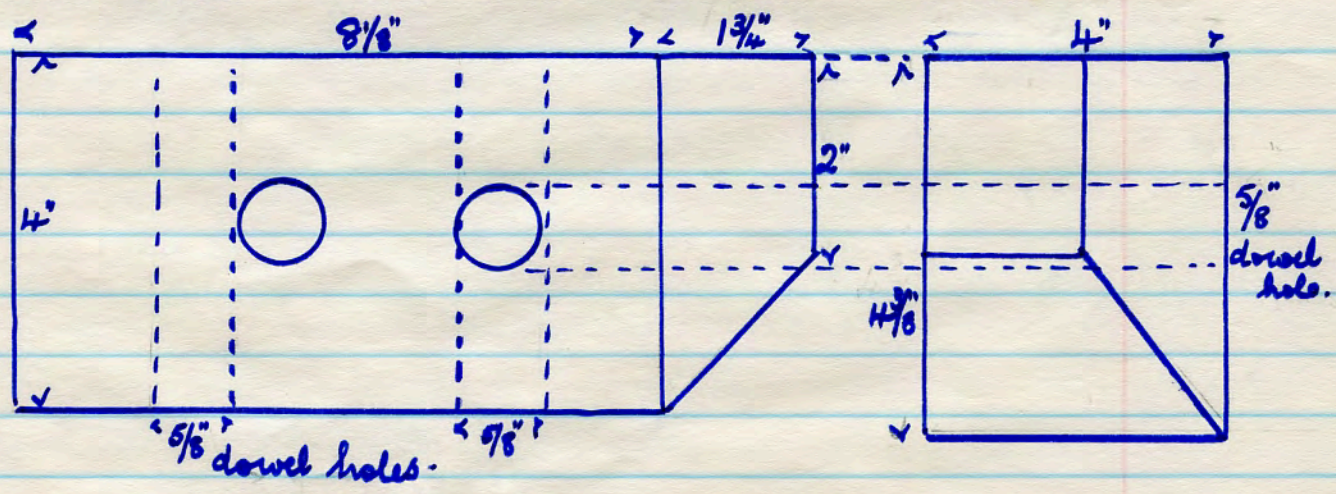

All above from Accrington Nori dem. site

3951

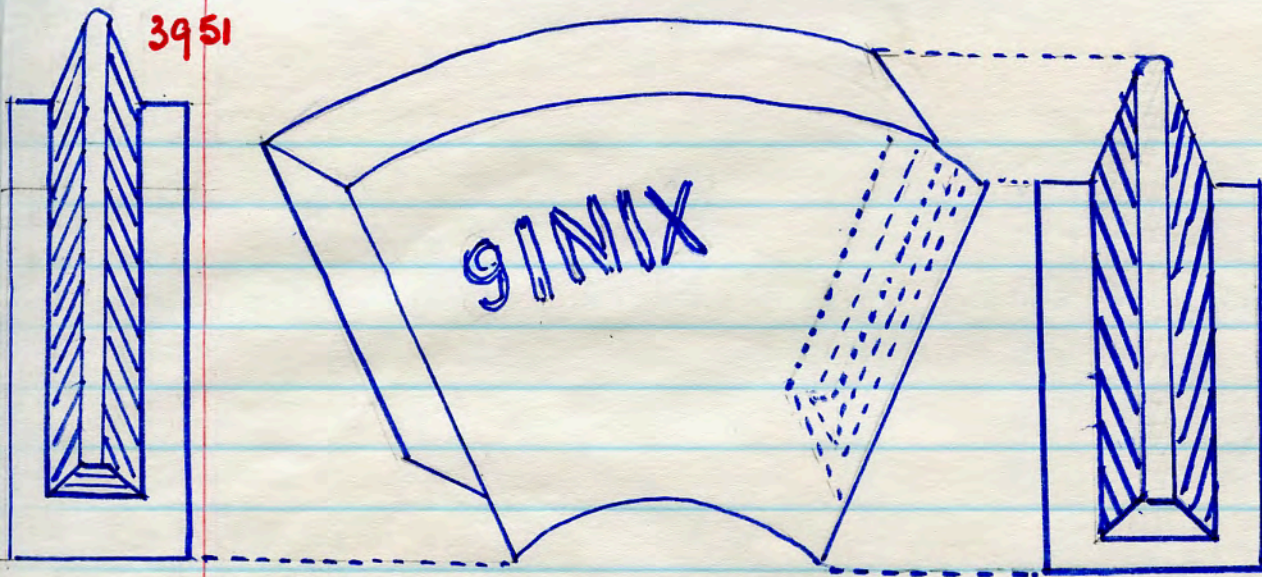

No name GINIX scribed. red T.C.

3952

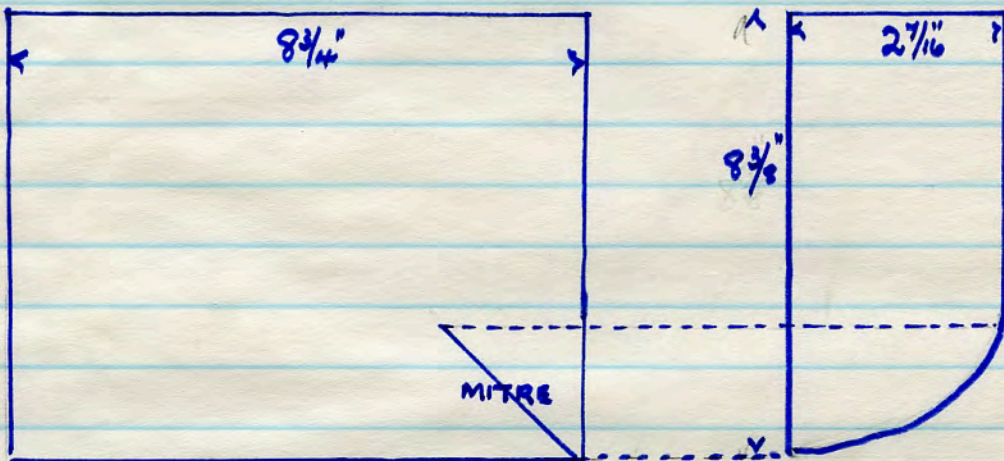

No name. 635 V F red T.C. 15 lbs.

50 x 1/8" holes in base for adhesion. bull nosed return

No name. TX

red T.C. floor tile 6 lbs.

3953

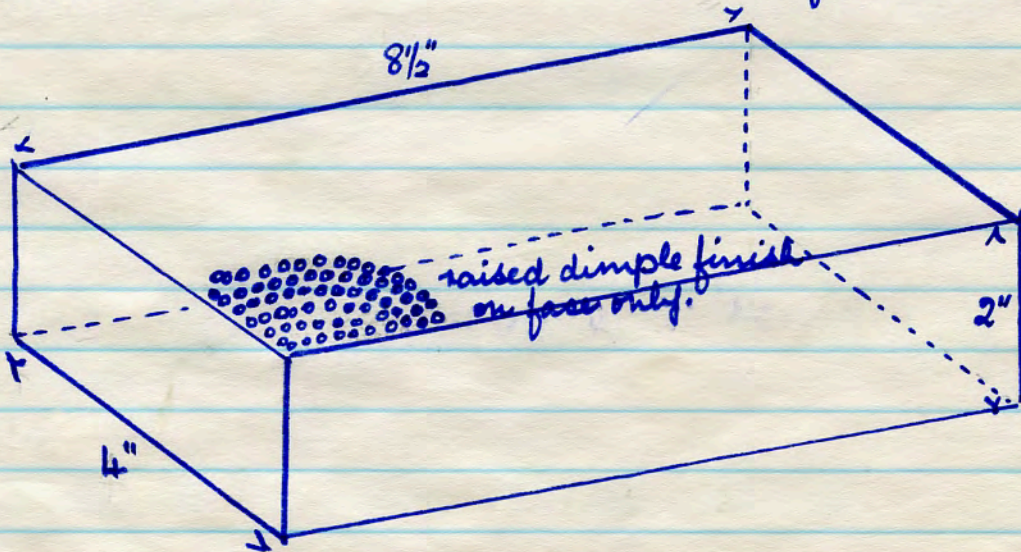

All from Acc/ten Moni dem. site 30. 10. '88

3954

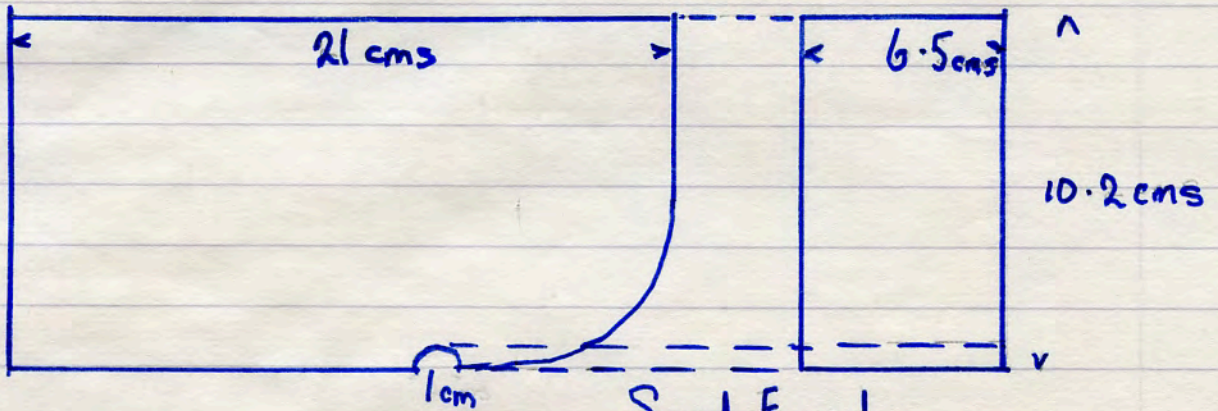

Sand Faced

No name. 64 U red T.C. 8 lbs.

3955

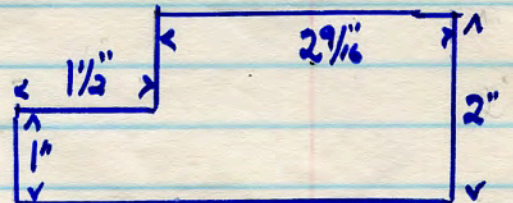
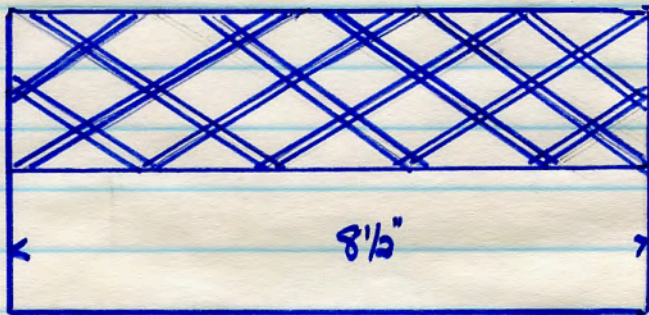

No name. O P L II red T.C.
5 lbs

3956

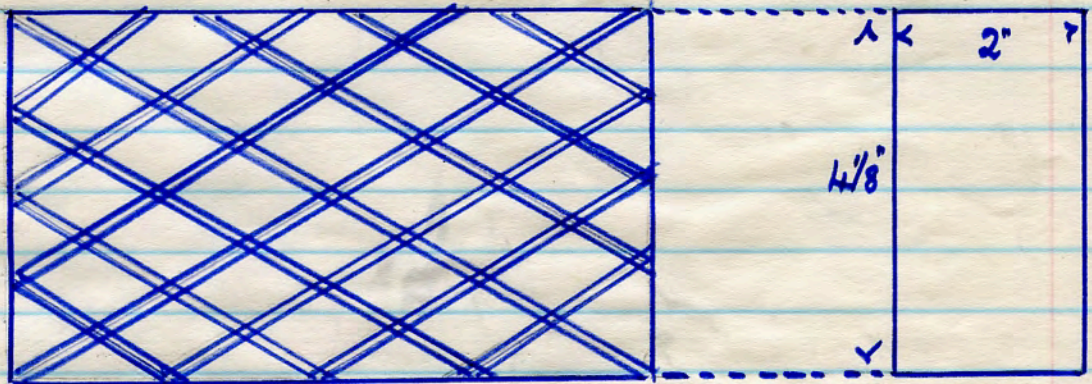

No name. RL red T.C. 6 1/2 lbs.

No name. no number. dark brown T.C. 4 lbs.

3957

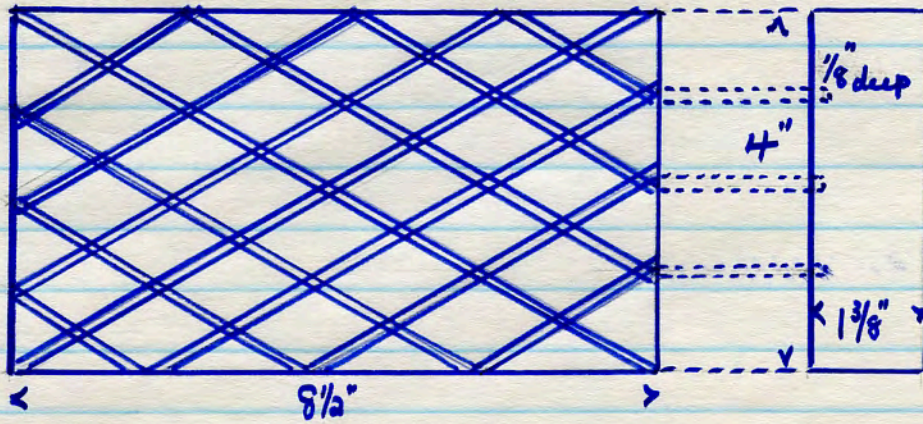

No name POG red T.C. 8 1/2 lbs.

3958

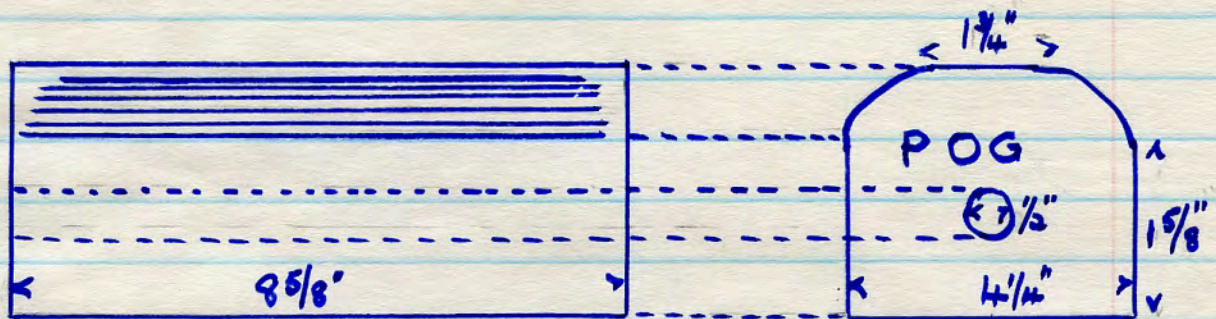

No name. P. red T.C. 8 lbs

3959

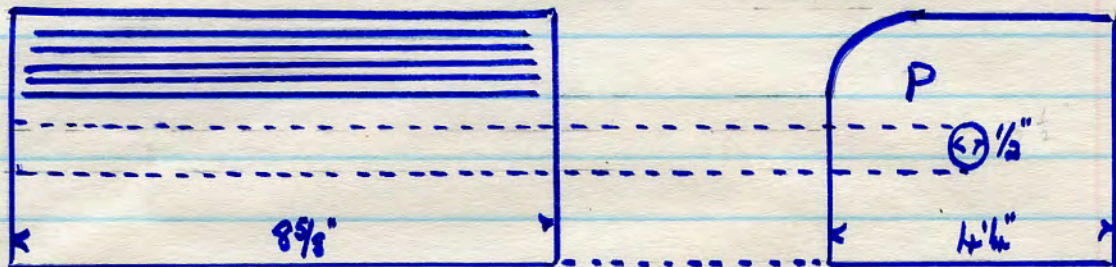

No name. 272 40 red T.C. 8 lbs.

3960

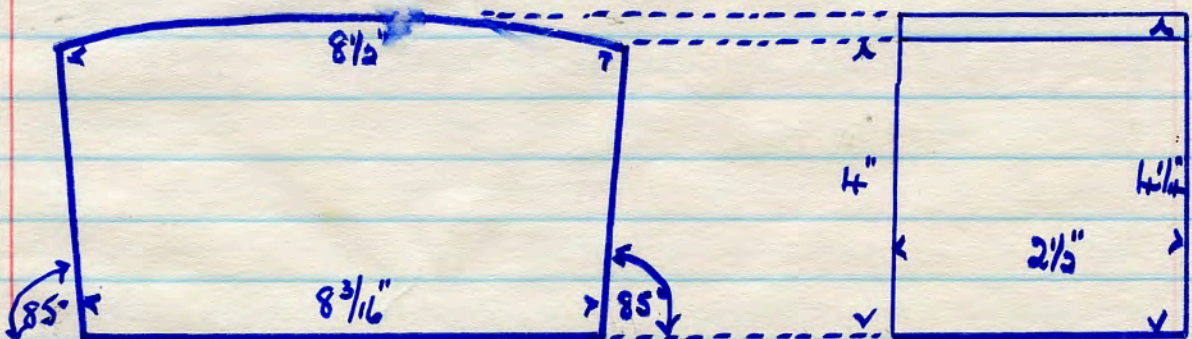

cambered in length
base line not cambered.

All from Acc/ton Mori dem. site 14. 11. '88.

3961

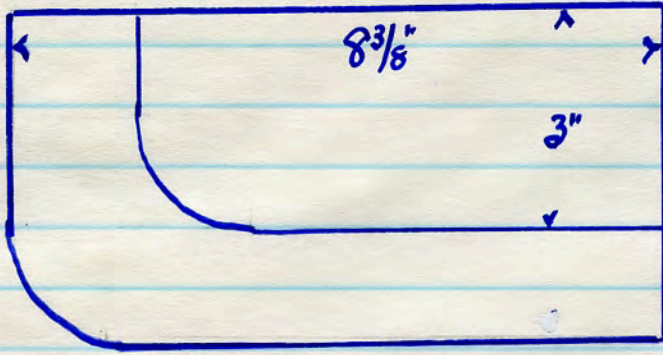

No name. PYR red T.C.
9 lbs.

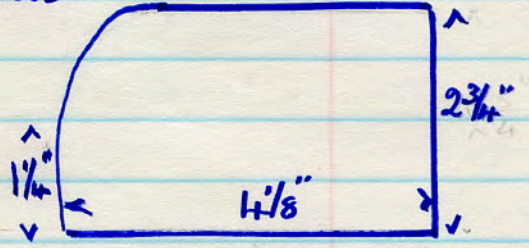

3962

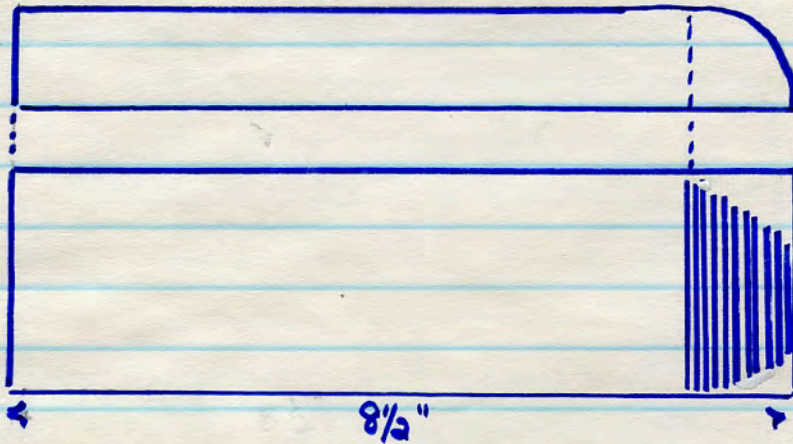

No name Z17 PH
red T.C.
5 lbs
all surfaces and
edges smooth

3963

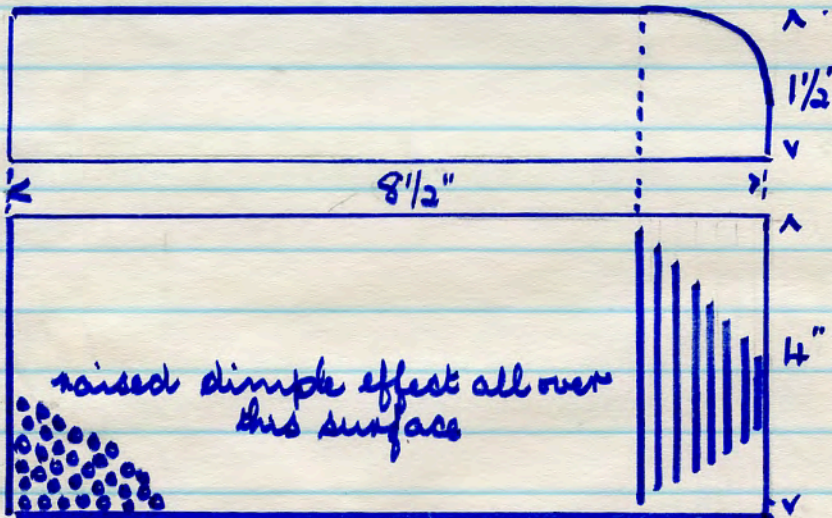

No name Z17 NH
red T.C.
5 1/2 lbs

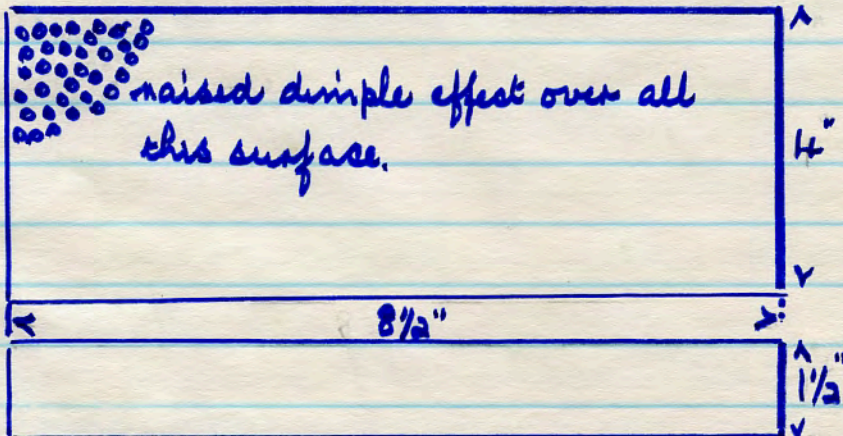

No name. red T.C.
no number lbs.

3964

3965

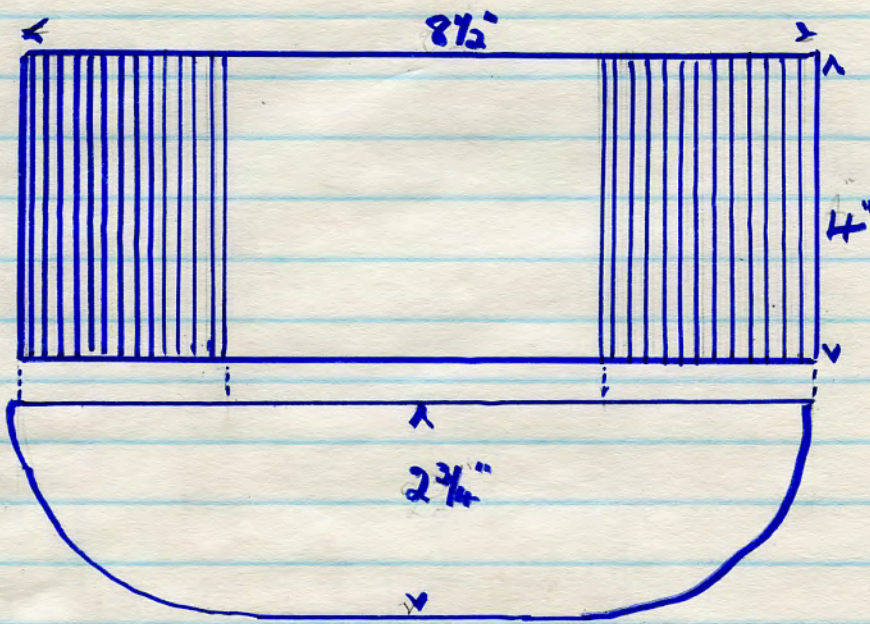

no name.
 23 132
 red T.C.
 8 lbs.

3966

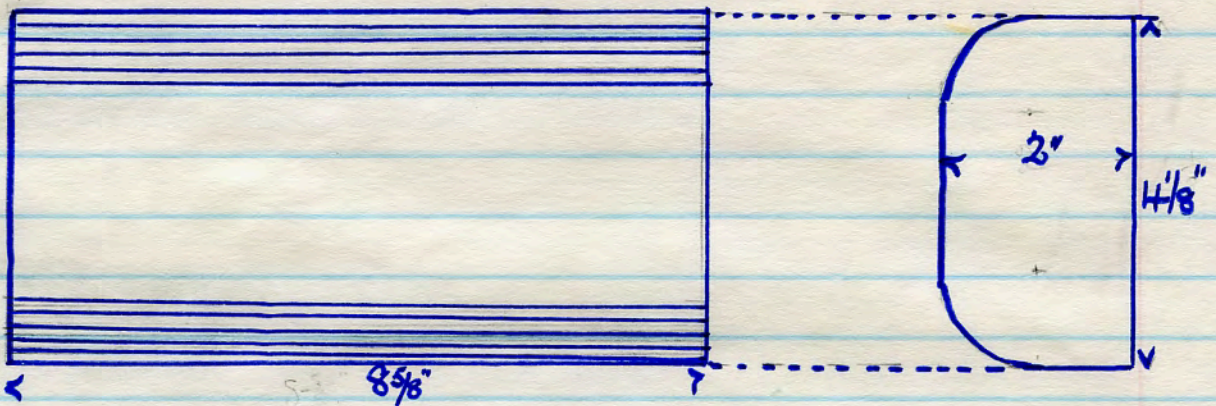

no name. P 2X red T.C. 7 lbs

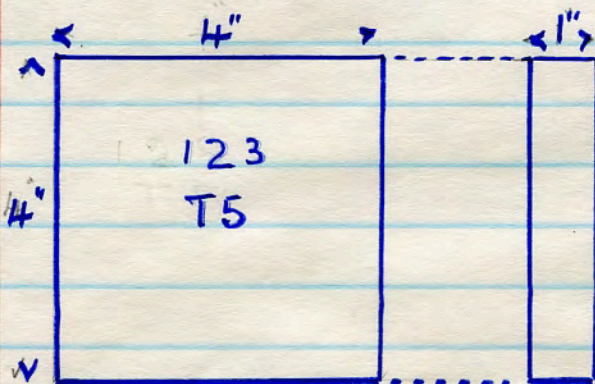

no name. 123 T5
 dark brown T.C.
 1 lb

3967

all from reception Mari dem. site 14. 11. 98

3968

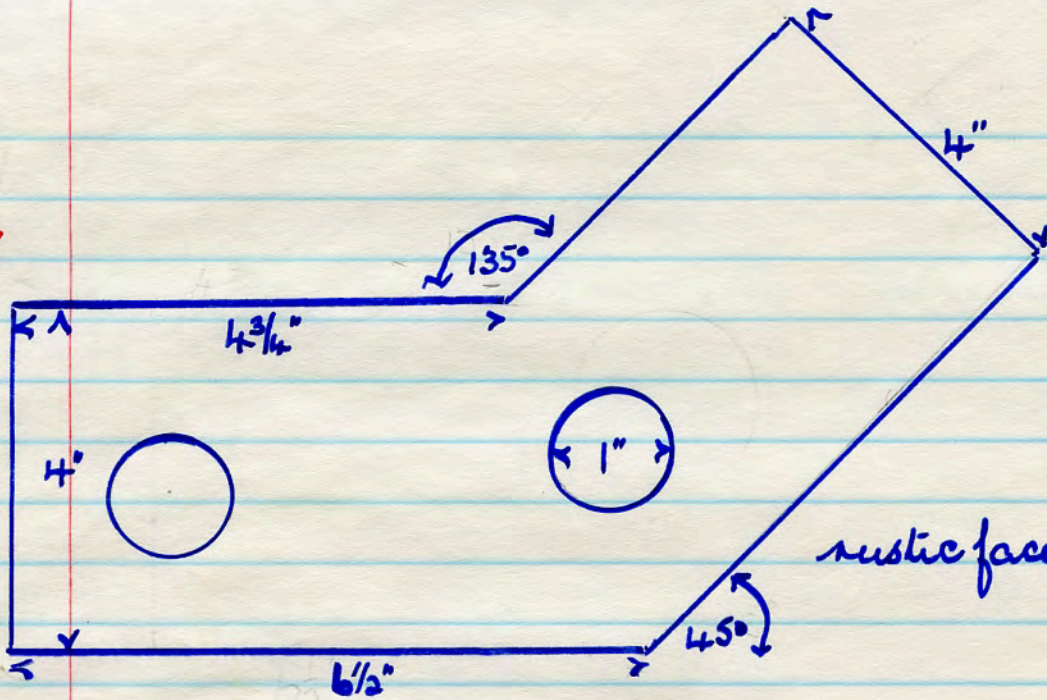

No name.
 4 22B.
 red T.C.
 8 lbs
 rustic face edges only.

Acc/ton Hosi dem. site 15. 11. 88.

3969

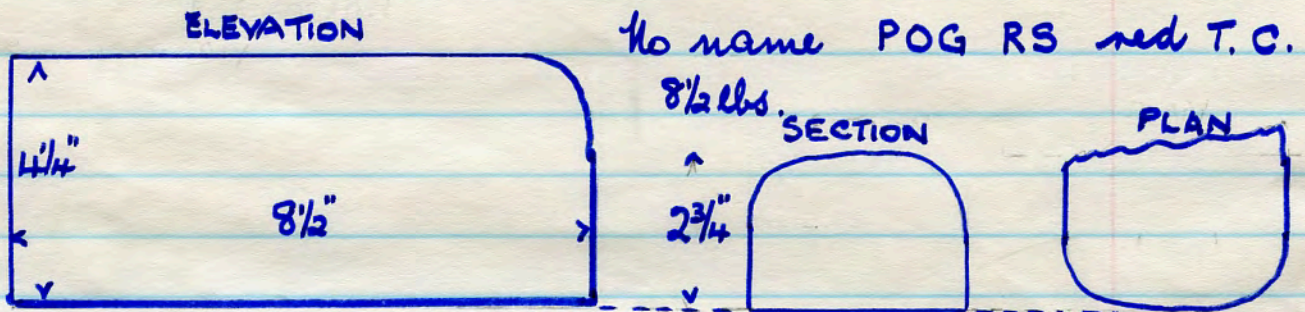

3970

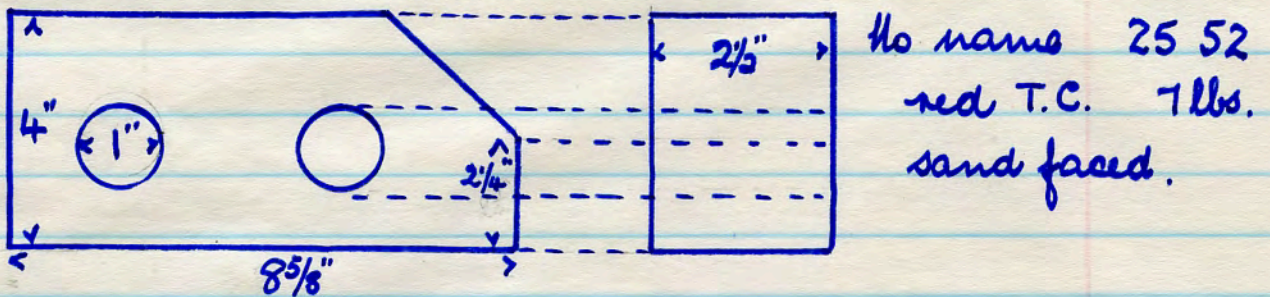

3971

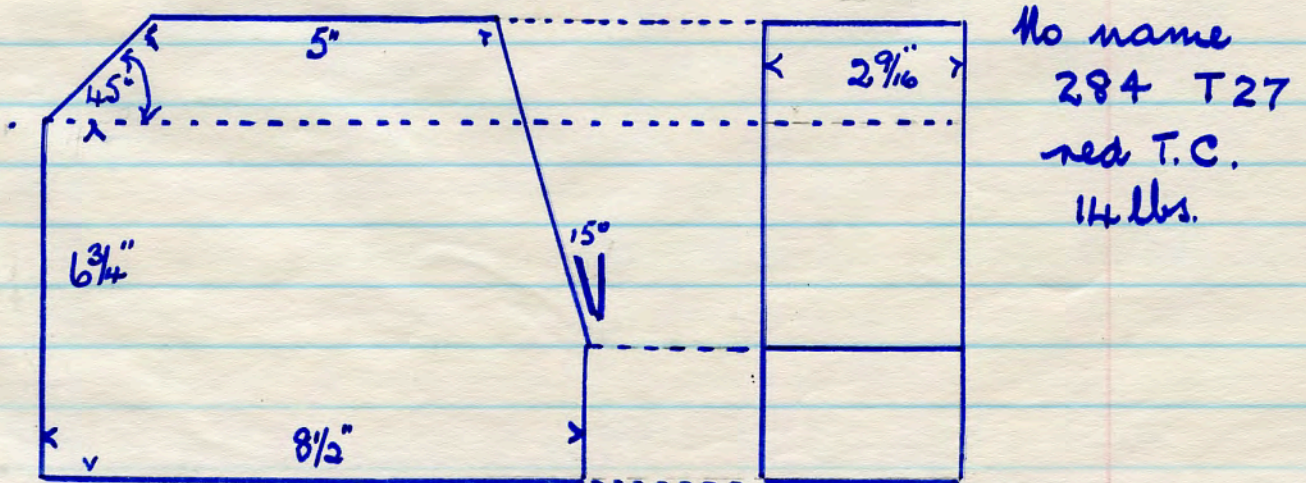

3972

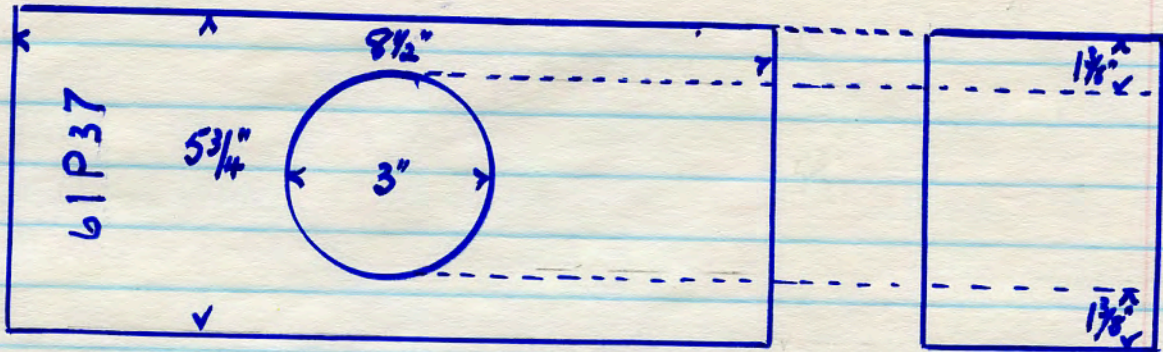

No name. 61P37. red T.C. $8\frac{1}{2}'' \times 5\frac{3}{4}'' \times 4''$. 14 lbs.
 " " 920Y " " $12'' \times 6'' \times 2''$ 14 lbs.

3973

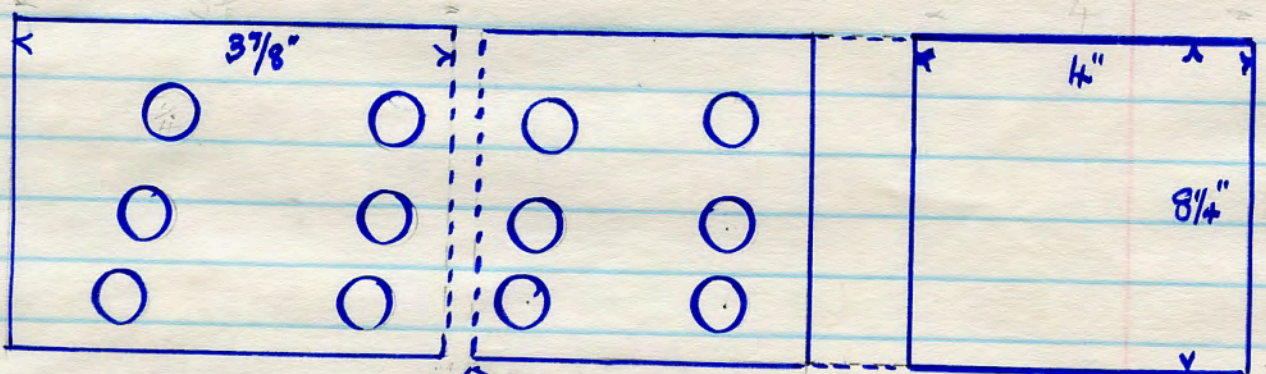
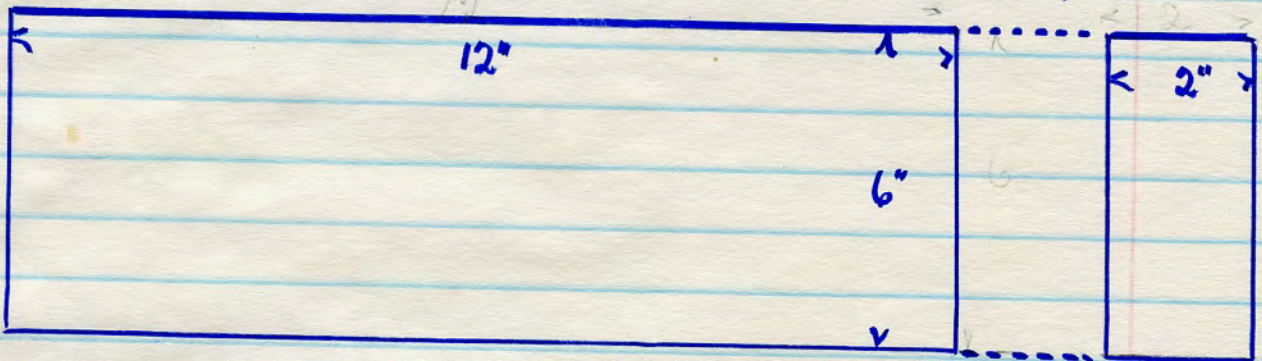

3974

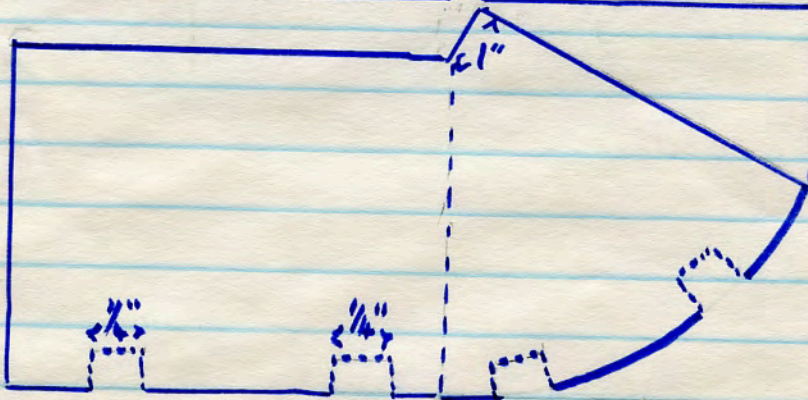

No name.
 35 N 8
 red T.C bull nose
 block.
 18 lbs.

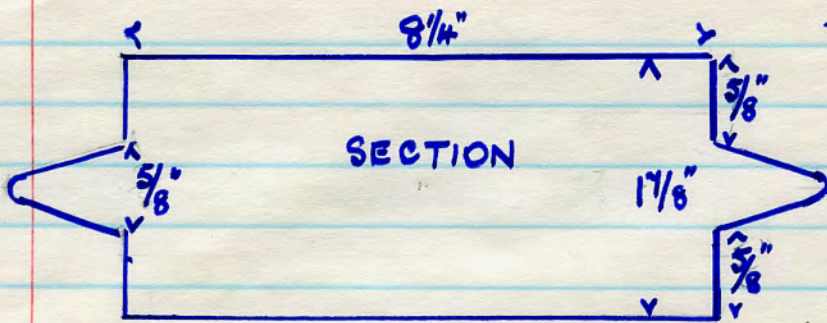

no name STX
red T.C. disc (base)
14 lbs.

3975

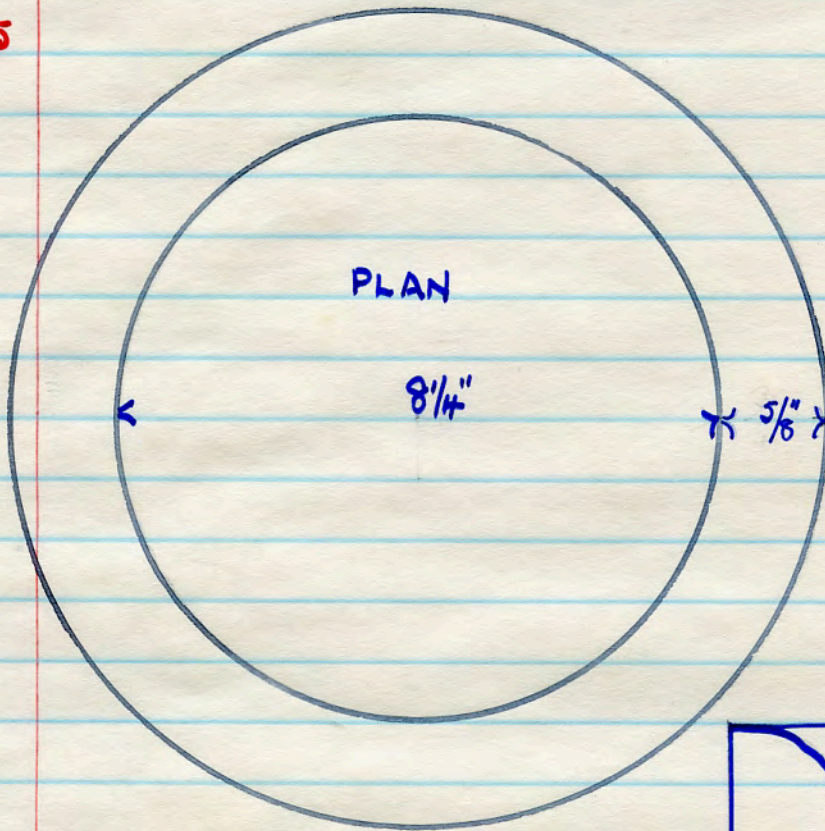

no name. IRB
stamped TH (maker)
red T.C.
7 lbs

3976

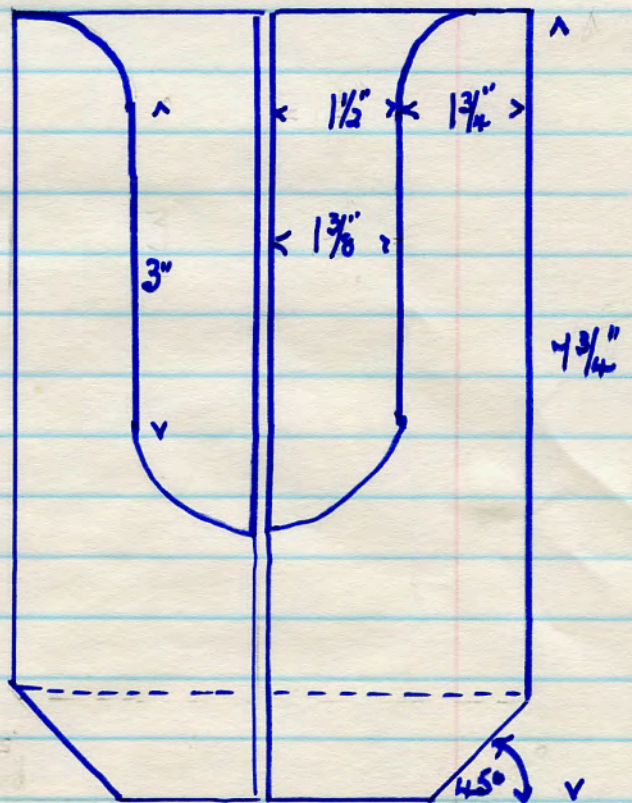
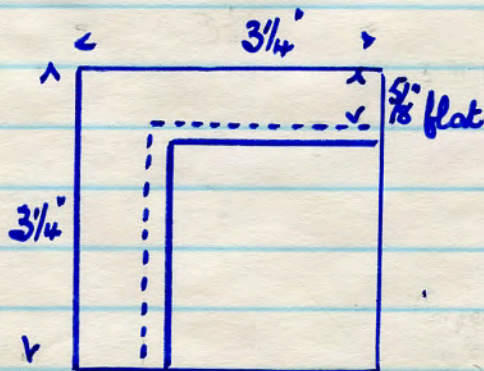

corners chamfered to allow better fixing in an angle

3977

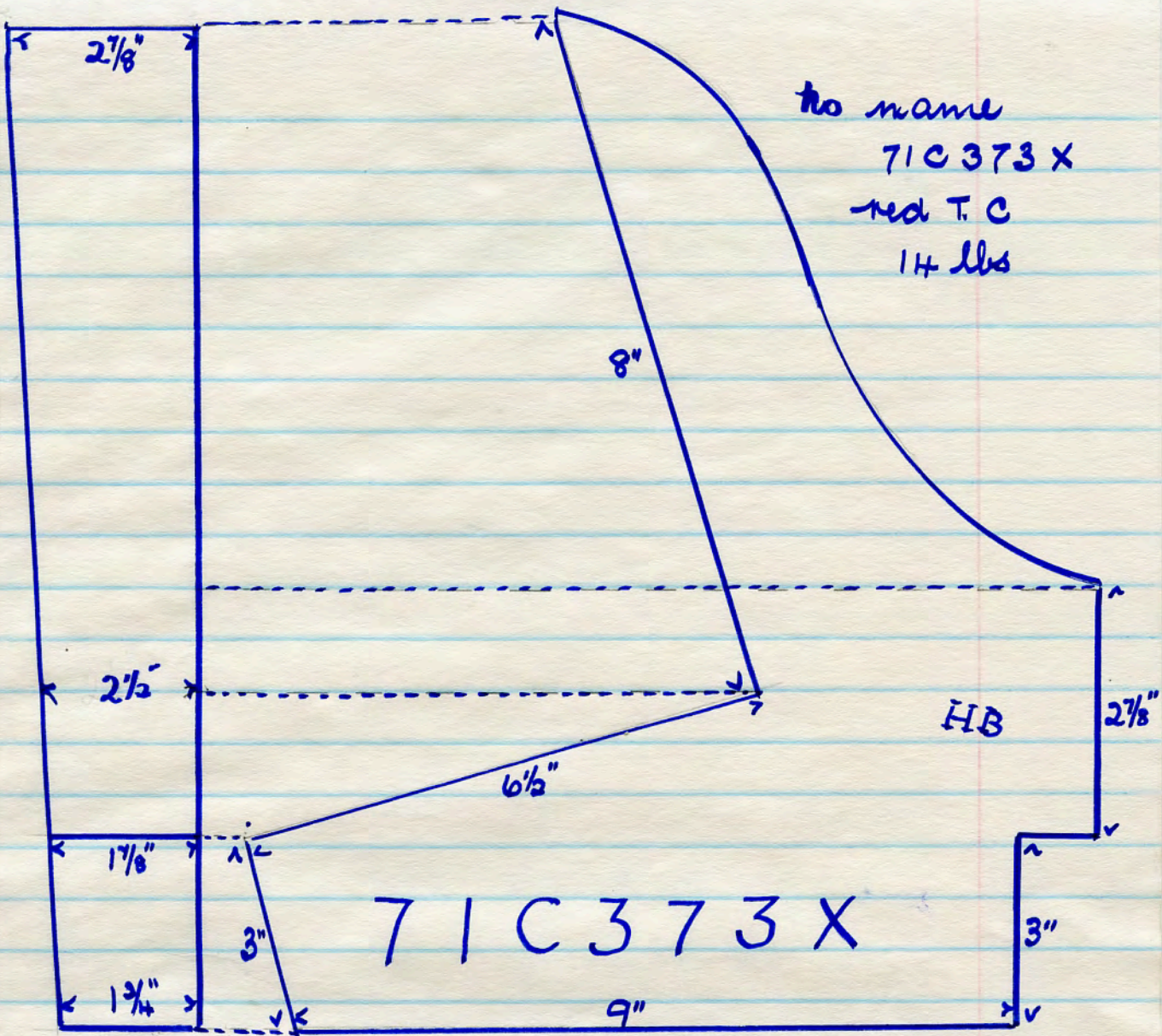

3979

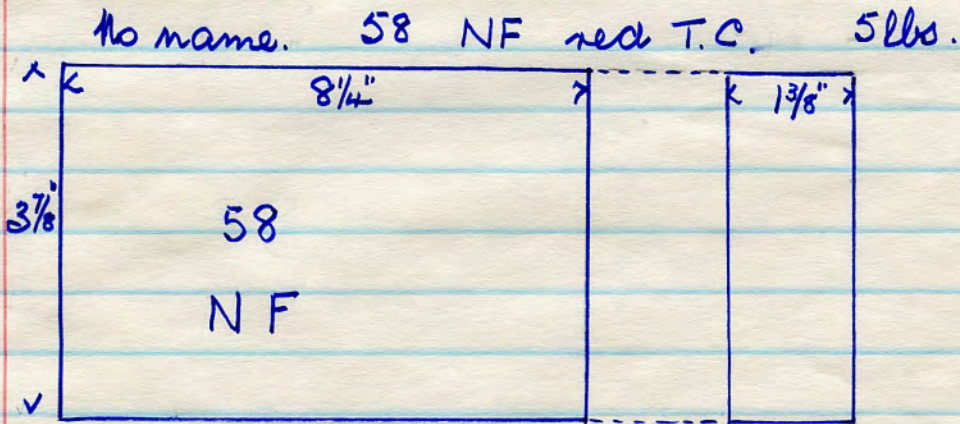

3980

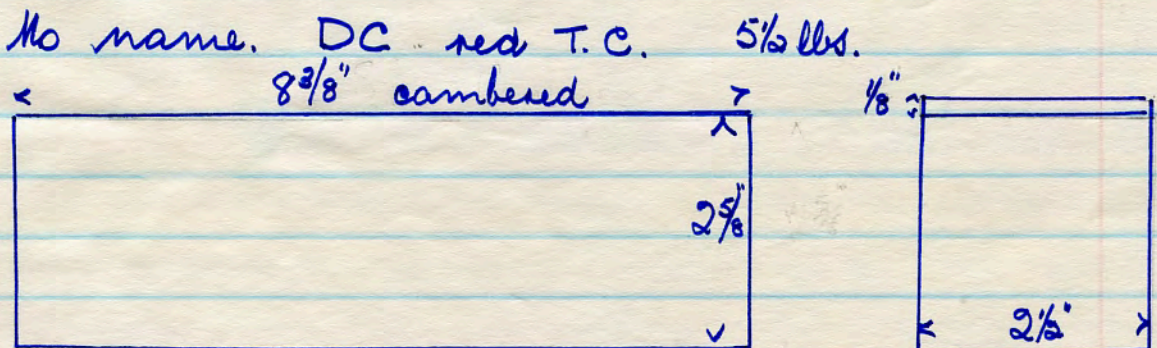

No name. 14 L. red T.C. 7 lbs.
JC maker's name, stamped.

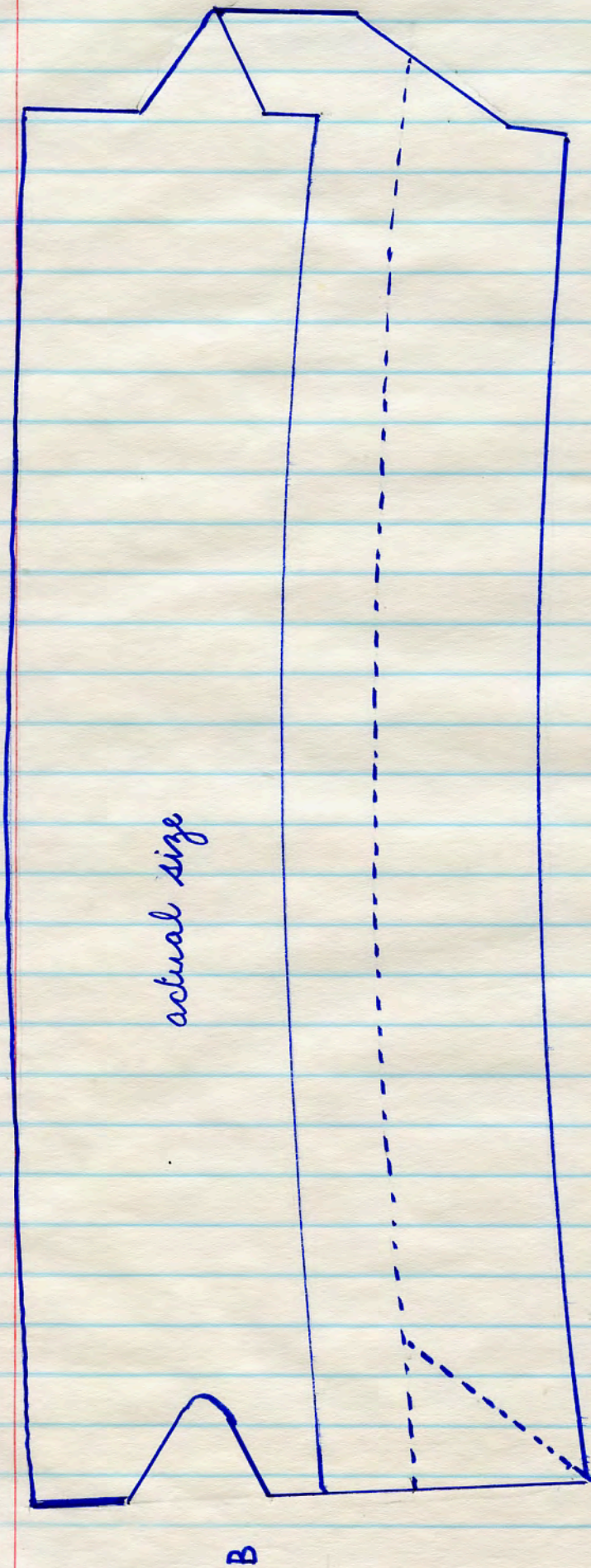

actual size

B

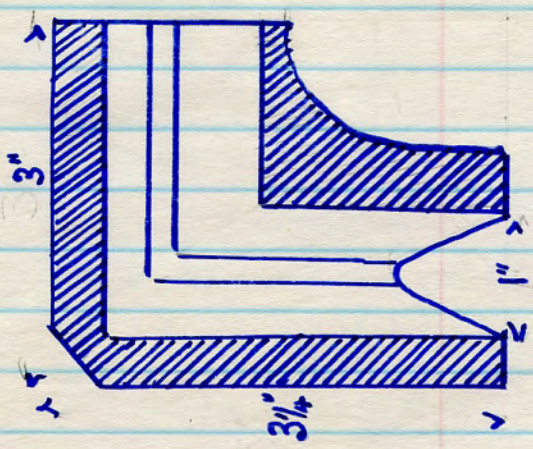

B end all groove

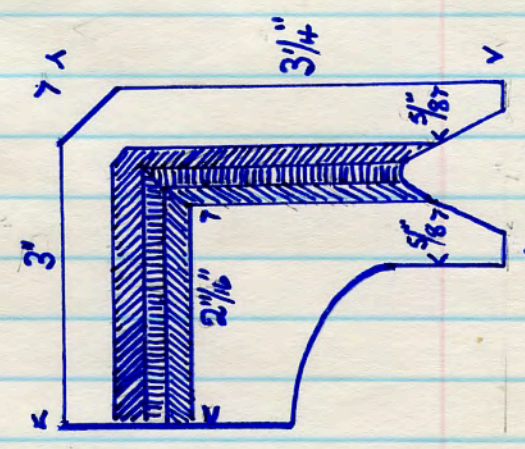

A end all tongue

3978

No name. PMK red T.C. 3 lbs. 1 scribed on opp. side

3981

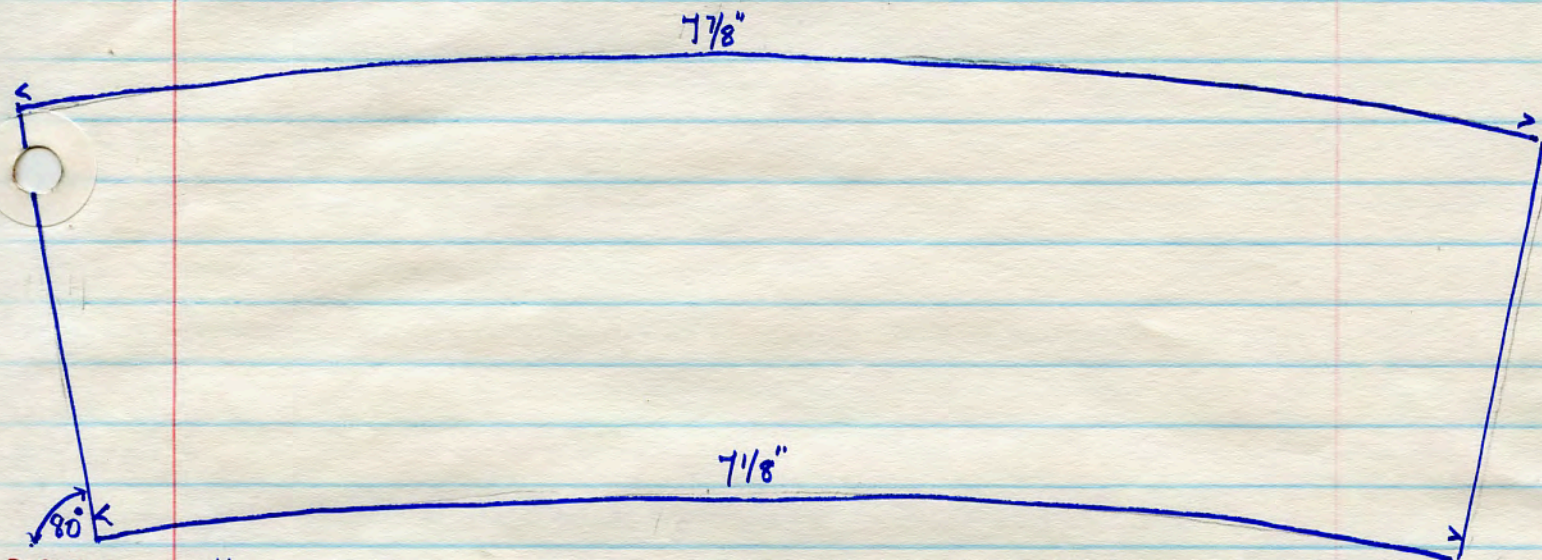
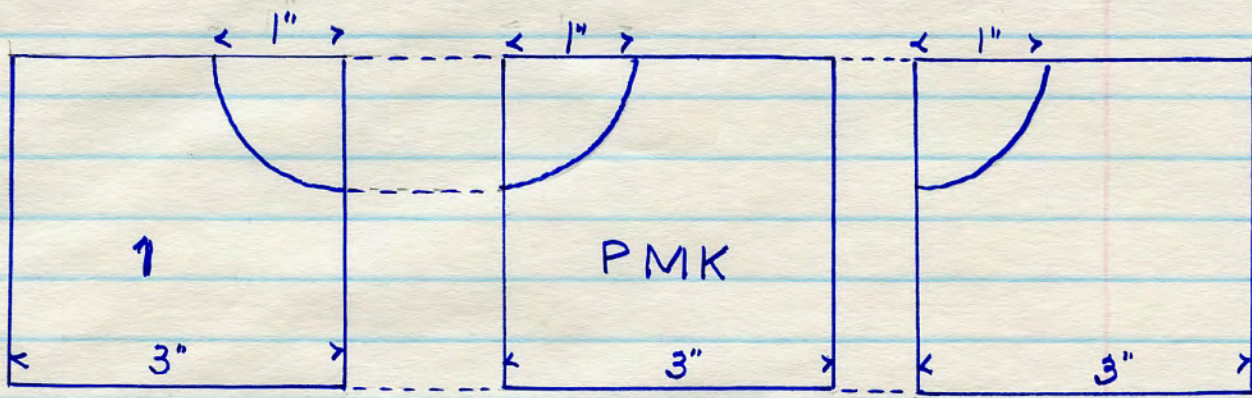

3982 No name. 12 H red T.C. 8 lbs. $2\frac{1}{8}$ " thick

3983

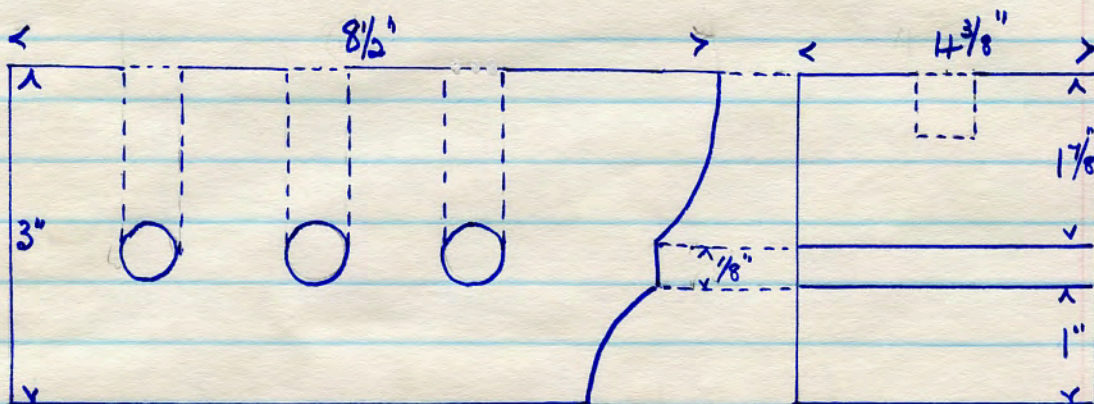

No name. 325 T red T.C. 9 lbs.

All from Acc/Kou Mori dem. site 14. 11. 88 - 18. 11. '88

No name 254 1CL dark brown T.C. 7 lbs.

3984

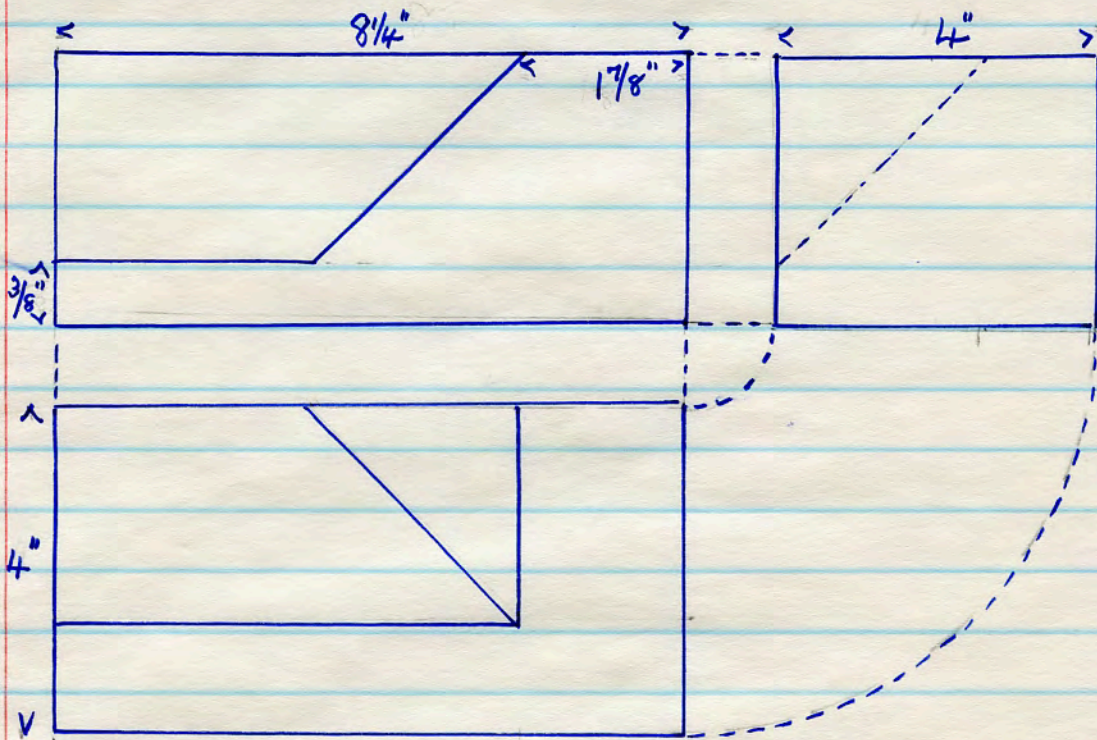

Acc/ton Mori dem. site 18. 11. '88.

3985

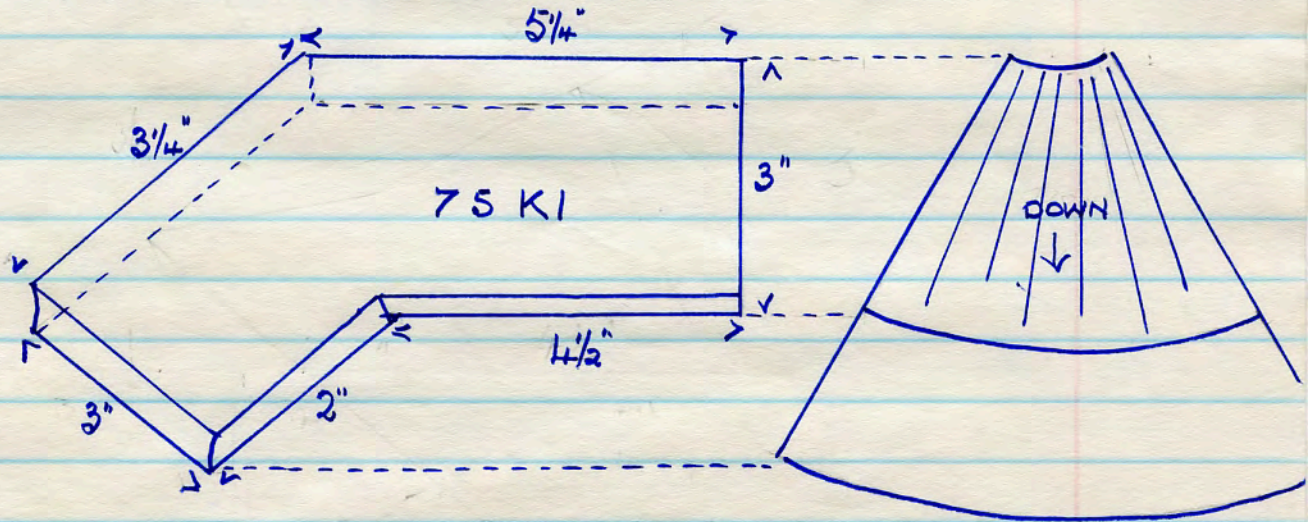

No name. 75 KI red T.C. 7 lbs.

3986

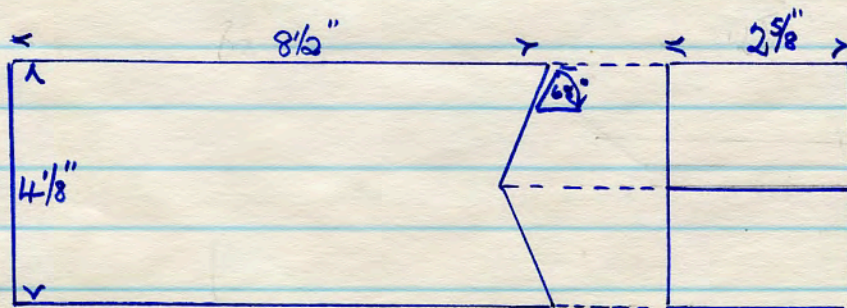

No name 2442 red T.C. 8 lbs

similar to 3748 except for pitch of bird mouth.
All from Acc/ton Mori dem. site 20. 11. 88.

to name. 52 R. red T.C. 8 lbs.

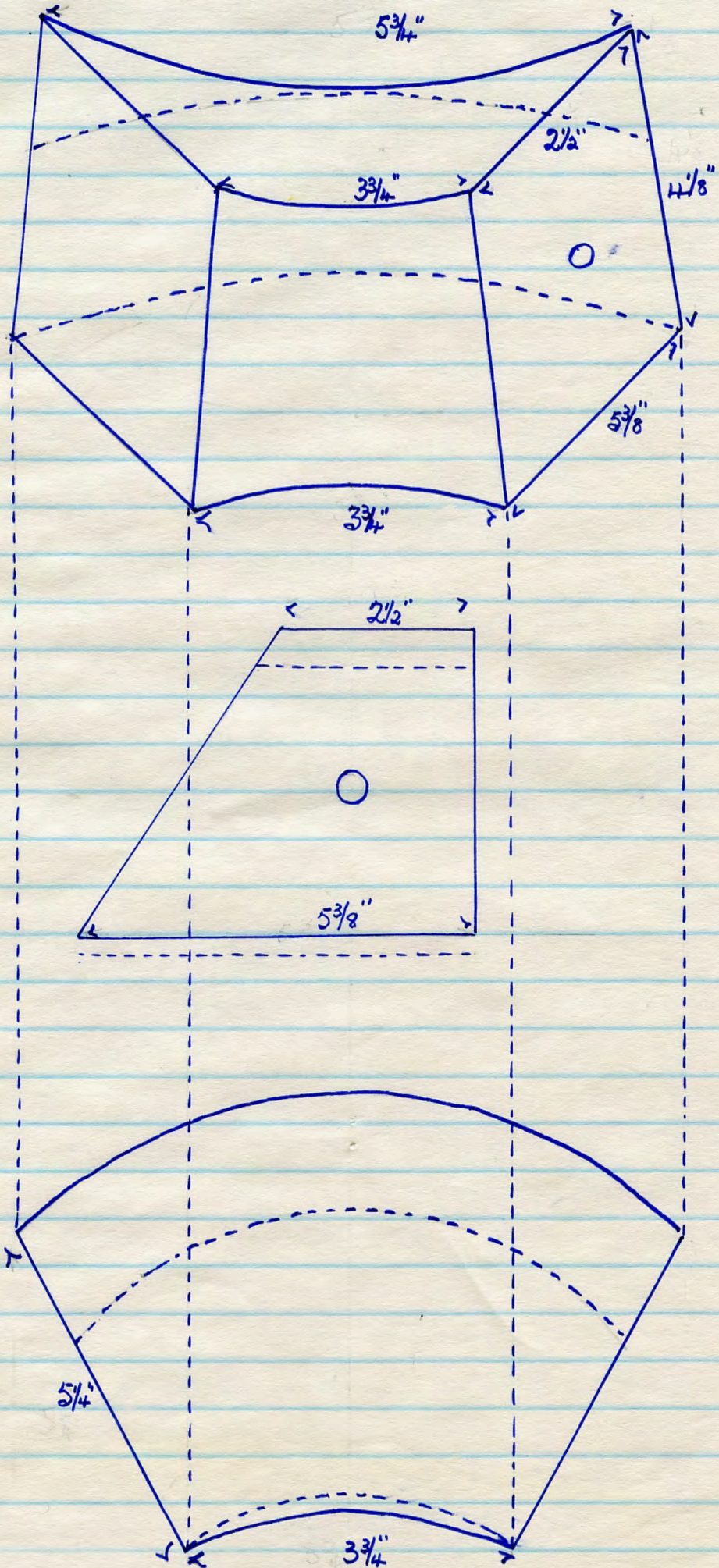

3987

No name. 2552. red T.C. 8 lbs.

3988

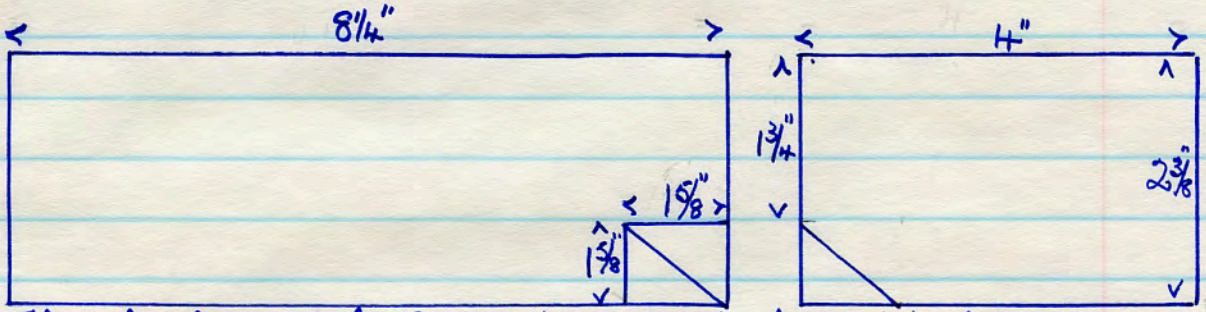

This brick is right hand to 3917 which is left hand

3989

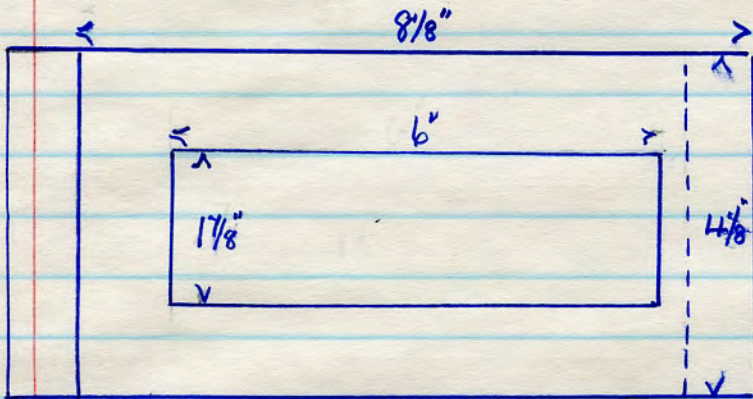

No name. 371 W
179 X

red T.C. 8 lbs.
single panel 1/8" deep each
side

stretcher to H015.

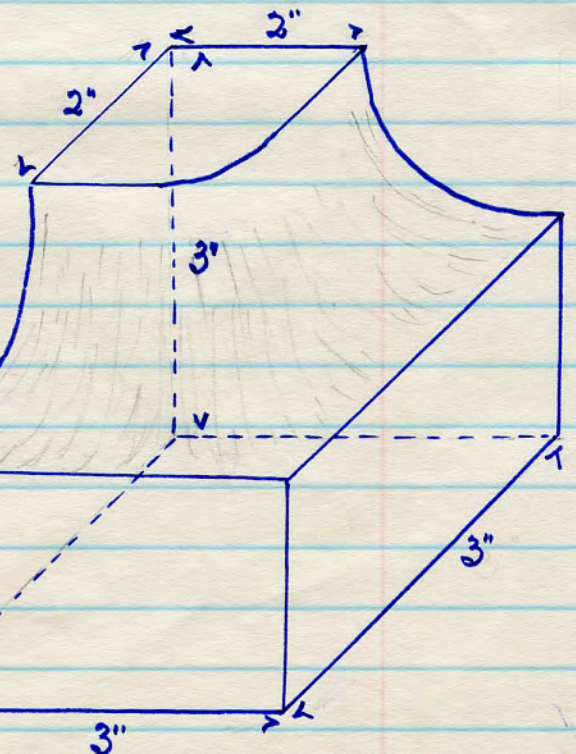
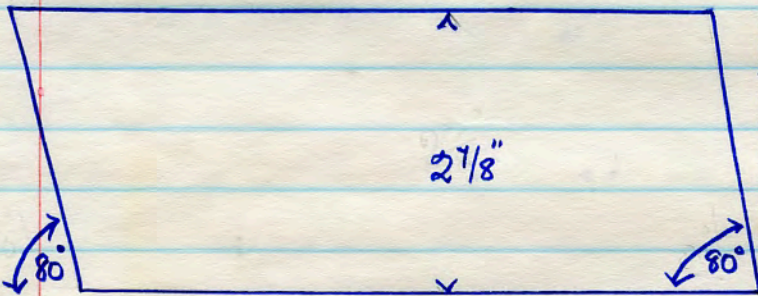

3990

No name. PL100
red T.C. 2 lbs

All from Acc/ton Mori dem. site 19. 11. 88.

3991

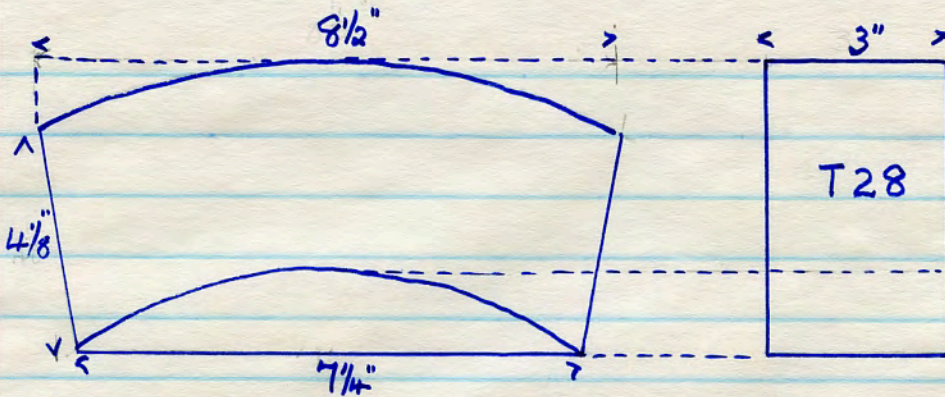

No name T28 red T.C. 8 lbs

No name. 2 AINT L5 red T.C. 12 lbs.

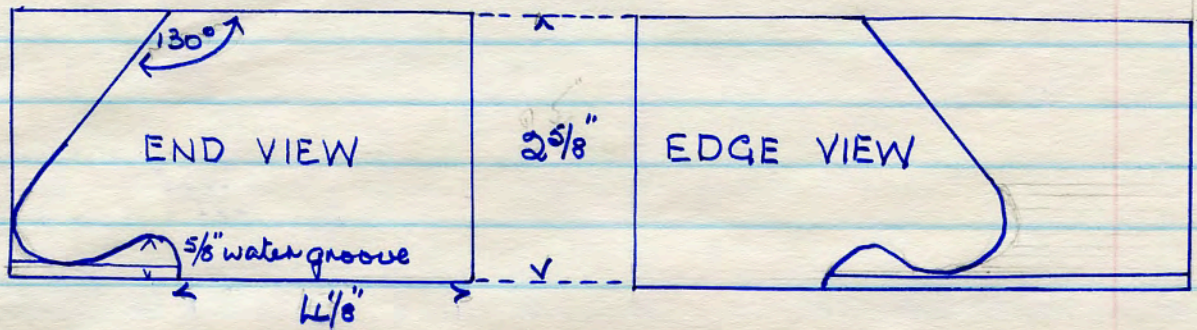

3992

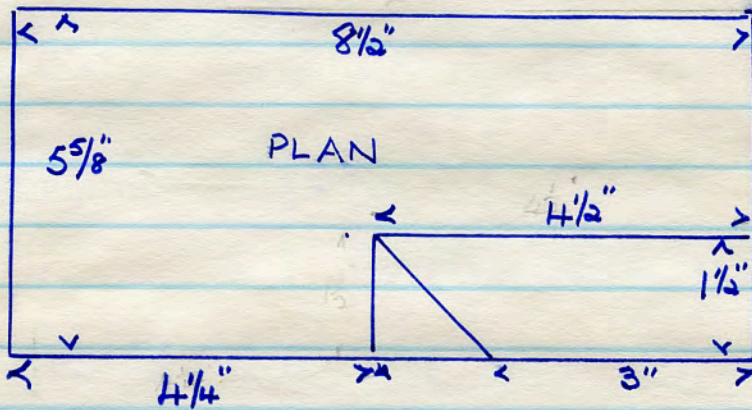

The above bricks is a left hand bricks - denoted by the letter L.

3993

No name 2 AINT R5 red T.C. 12 lbs.
similar bricks to 3992 but right hand - denoted by the letter R.

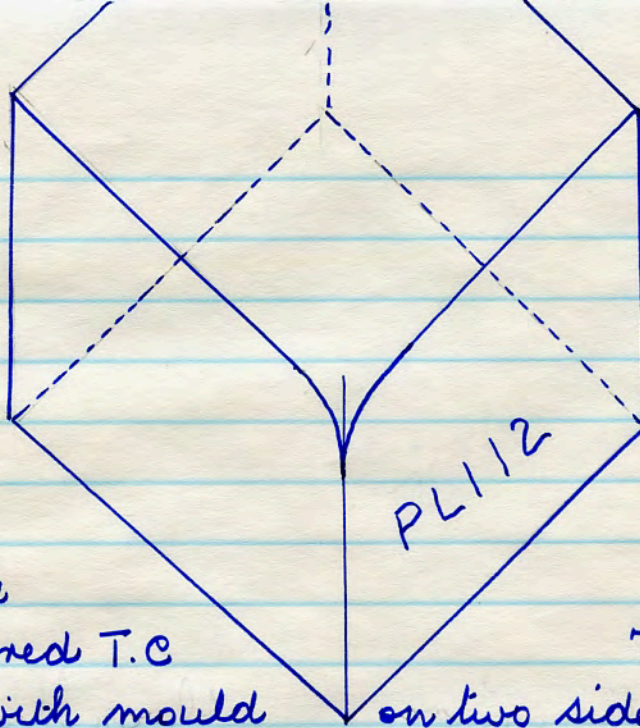

3994

No name
 PL112 red T.C
 7 lbs
 4" cube with mould on two sides, meeting in a mitre

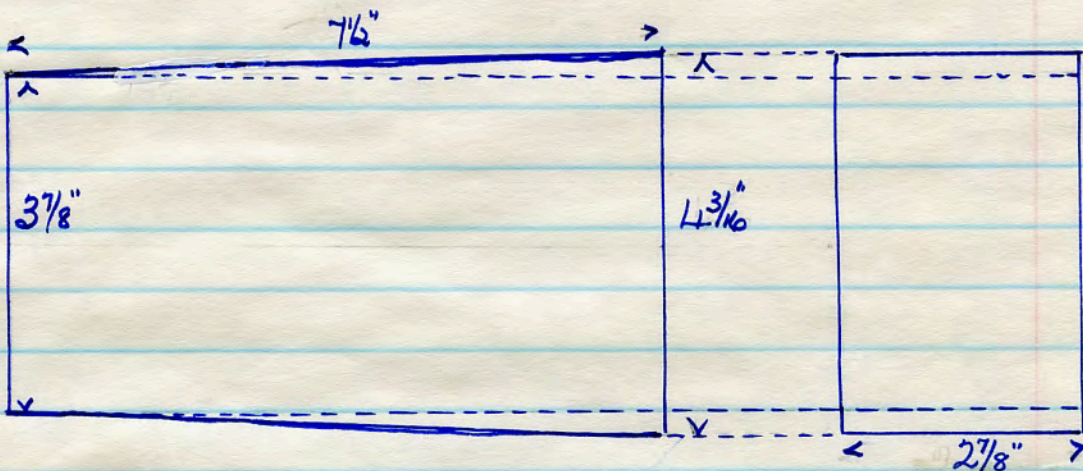

3995

No name. 322TB. red T.C. 8 lbs.

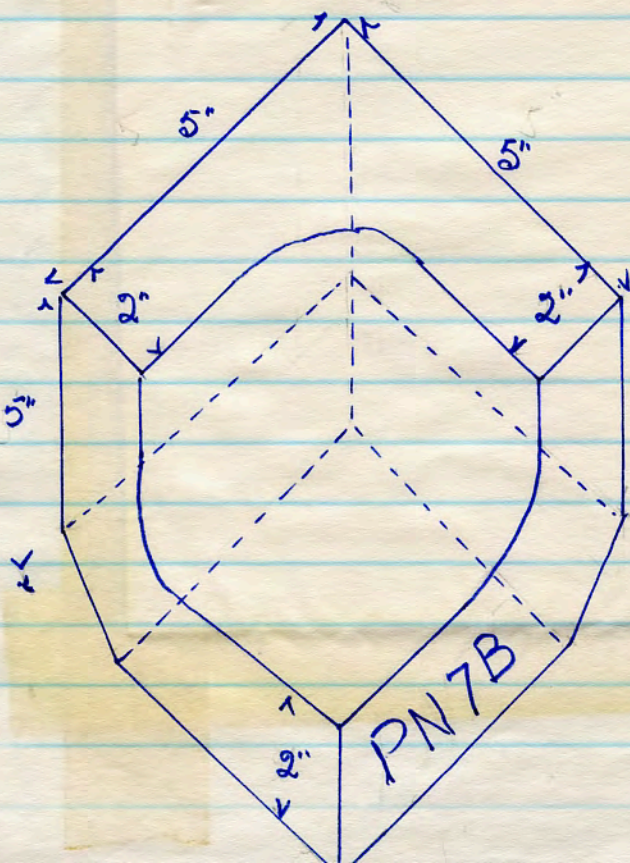

3996

No name PN7B
 red T.C 9 lbs.

All from Acc/ton Mori
 dem. site 17. 11. '88

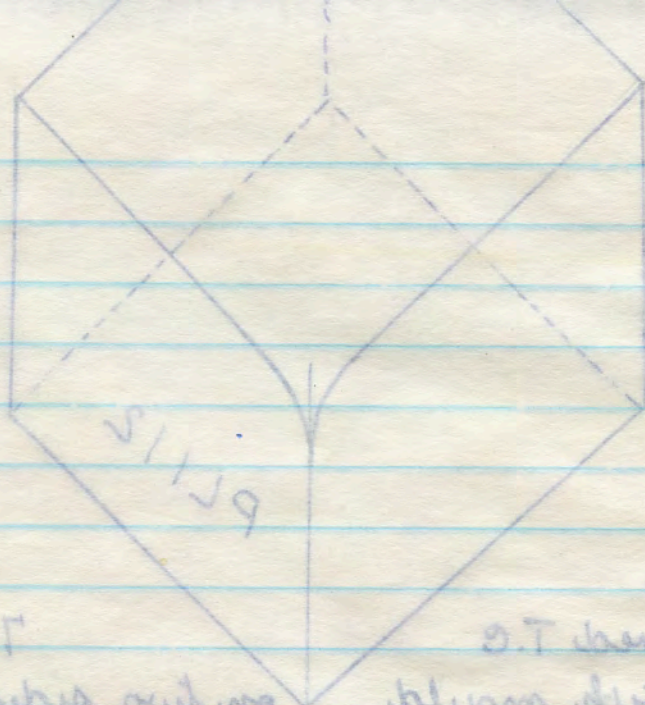

3PP8

all
 1 lb
 PL 112
 9.7 Jan 5 11 19
 all
 1 lb

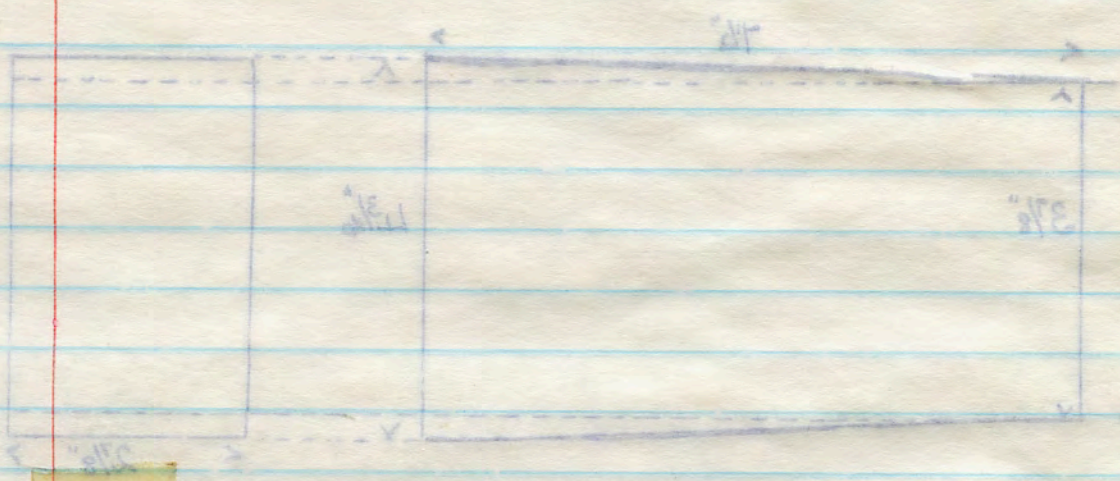

3PP8



3PP8

all from basket
 1 lb
 1 lb

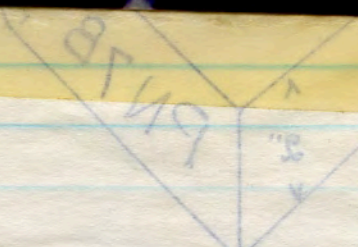

3997

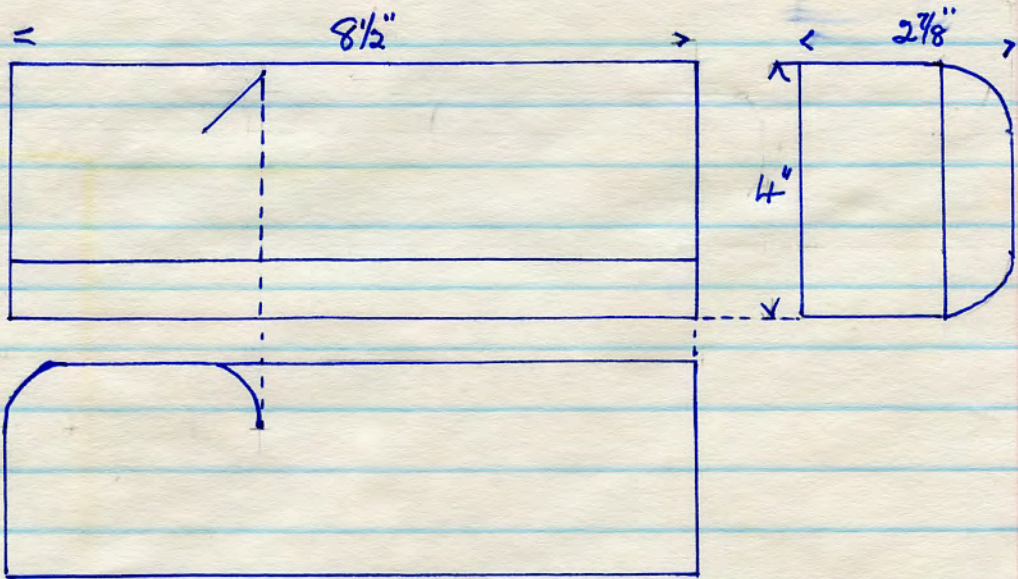

No name POGL red T.C 9 lbs.

3998

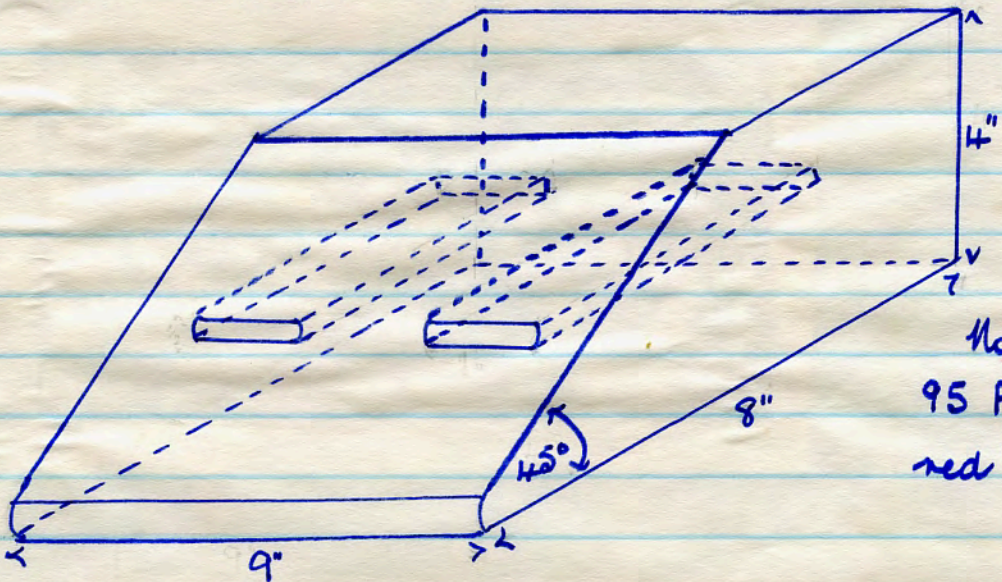

No name
95 P4
red T.C. 18 lbs.

3999

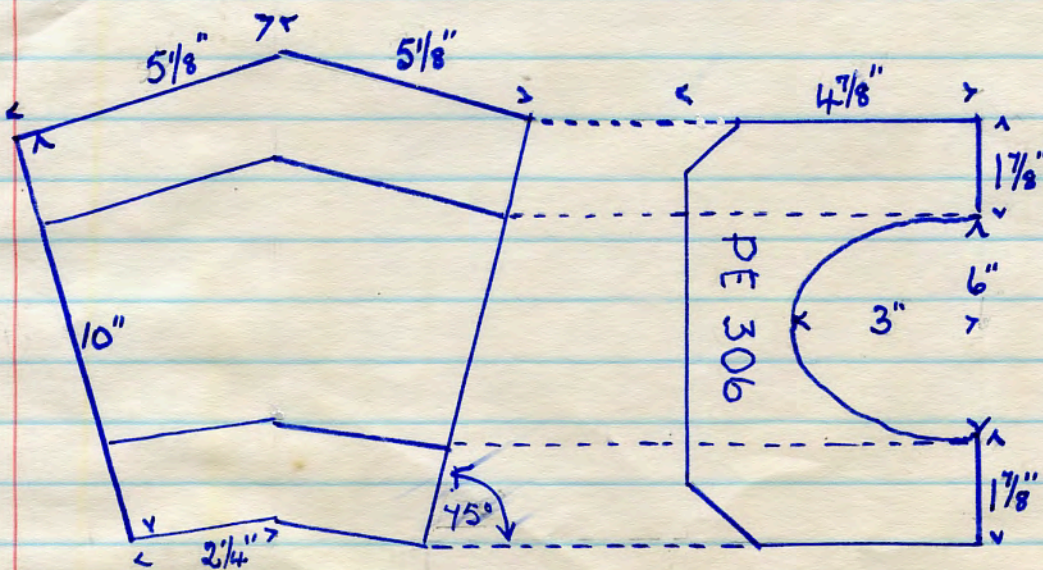

No name PE 306 red T.C. 22 lbs.

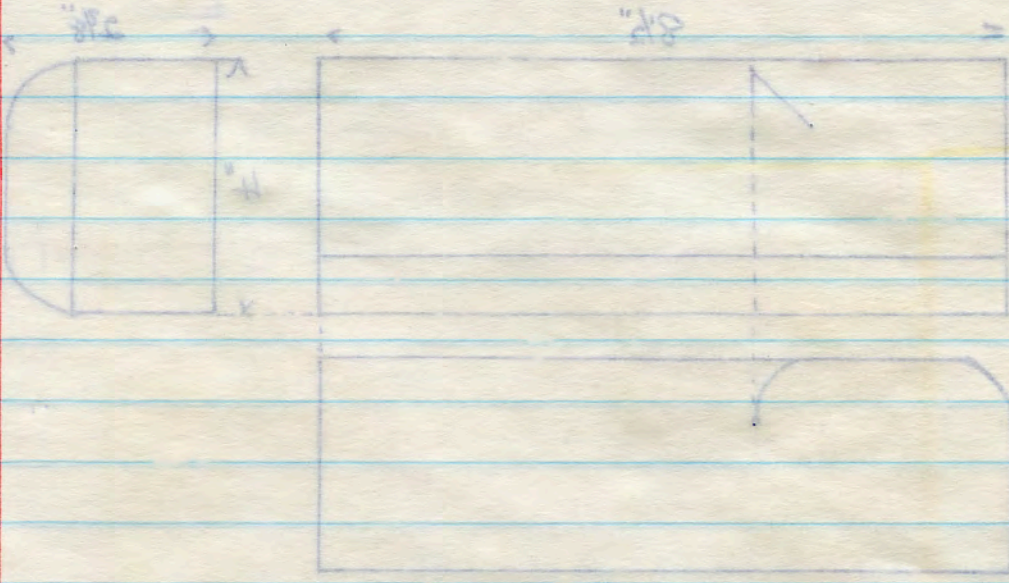

3PPE

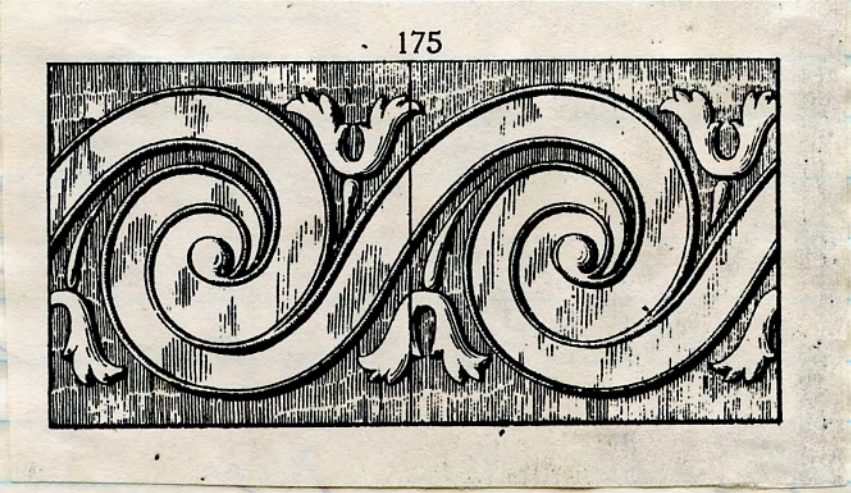

3PPE

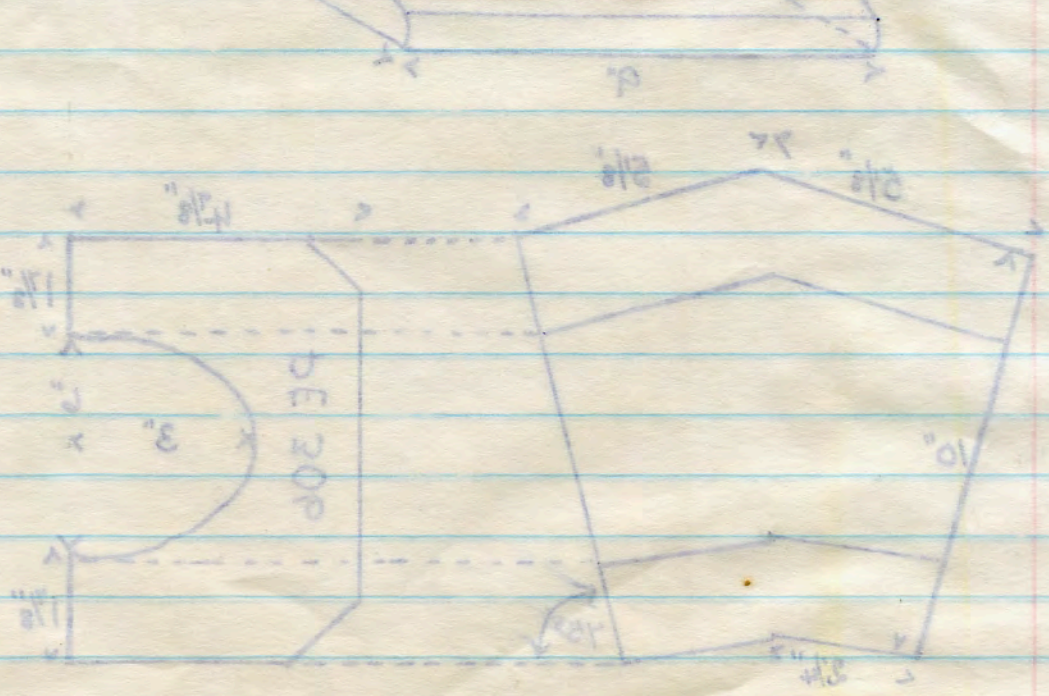

3PPE

The name PE 30P and T.G. 23/11/11

The name PE 30P and T.G. 23/11/11

ACCRINGTON NORI BRICK & TILE CO LD incised
red T.C dec. string course 30 lbs. $11\frac{3}{4}" \times 8\frac{7}{8}" \times 6"$

H000



2 cavities
 $3\frac{1}{2}" \times 3" \times 7"$ deep

No name no number red TC dec. plaque 19 lbs.
9³/₄" x 9³/₄" x 3". decoration stands 3¹/₄"

H001



cavity in rev.

Acclton Moai dem. site 16. 11. 88.

No 164 in Enfield Bsk & Jensa lotta Co. Ltd. catalogue.



No name 98 H12 red T.C. 8lbs.

BASE

TOP VIEW

RIGHT END

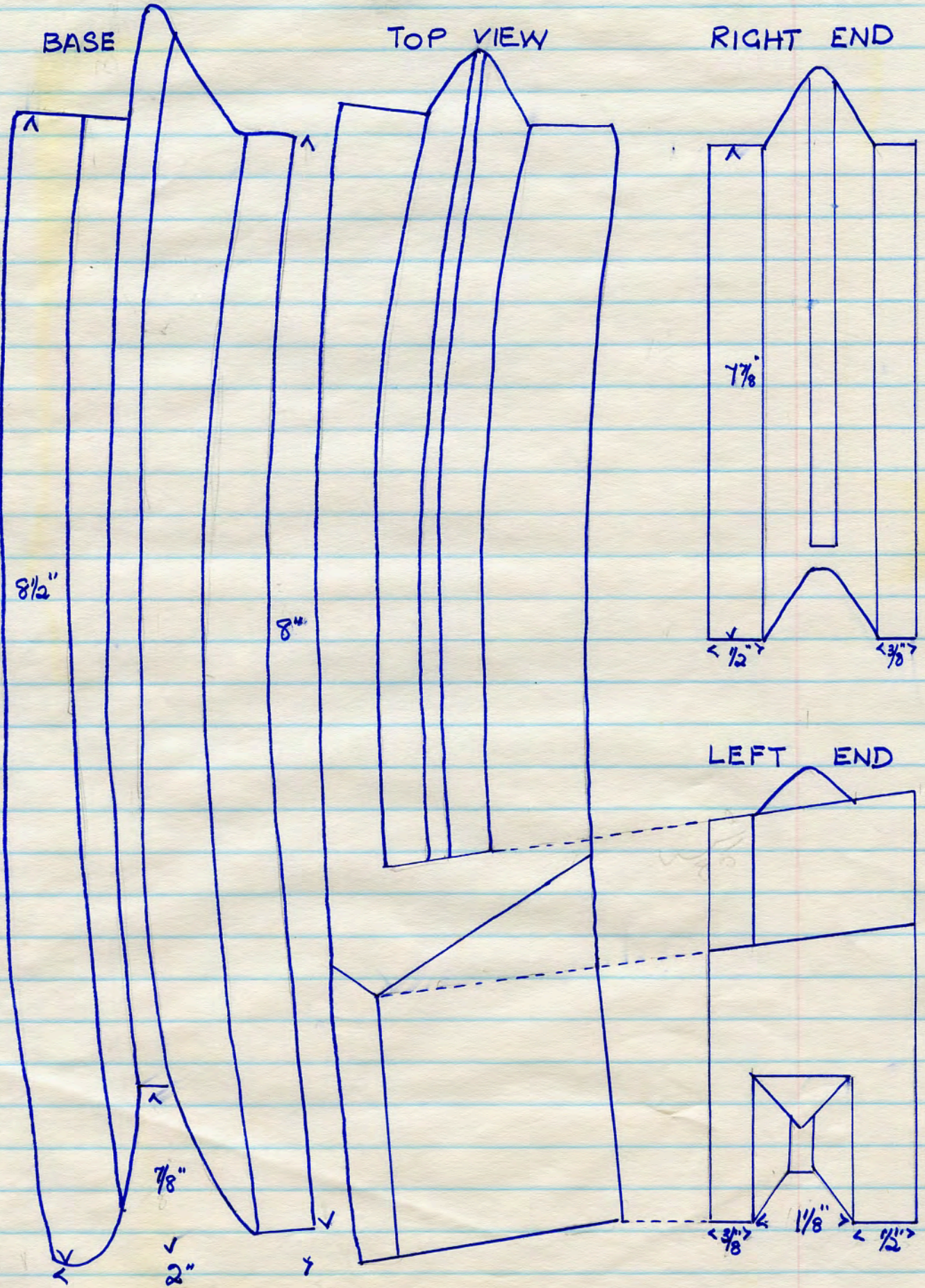

LEFT END

Acot/kon Mori dem. site 20. 10. '88.

No name PBB red T.C. 9 lbs

4003

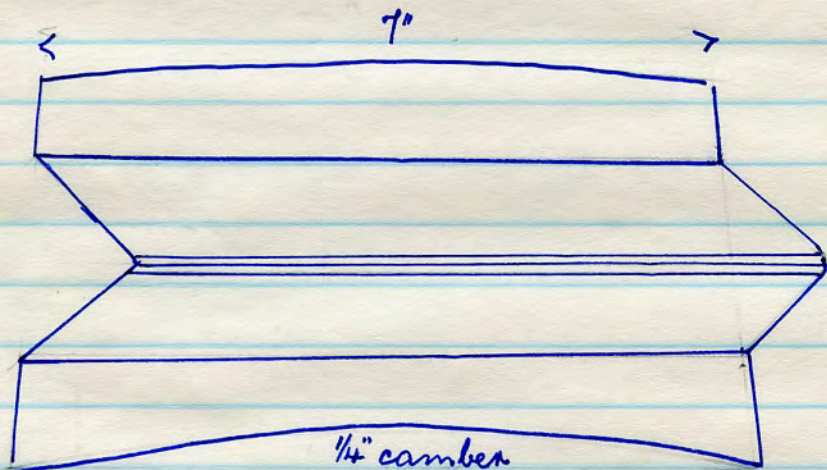
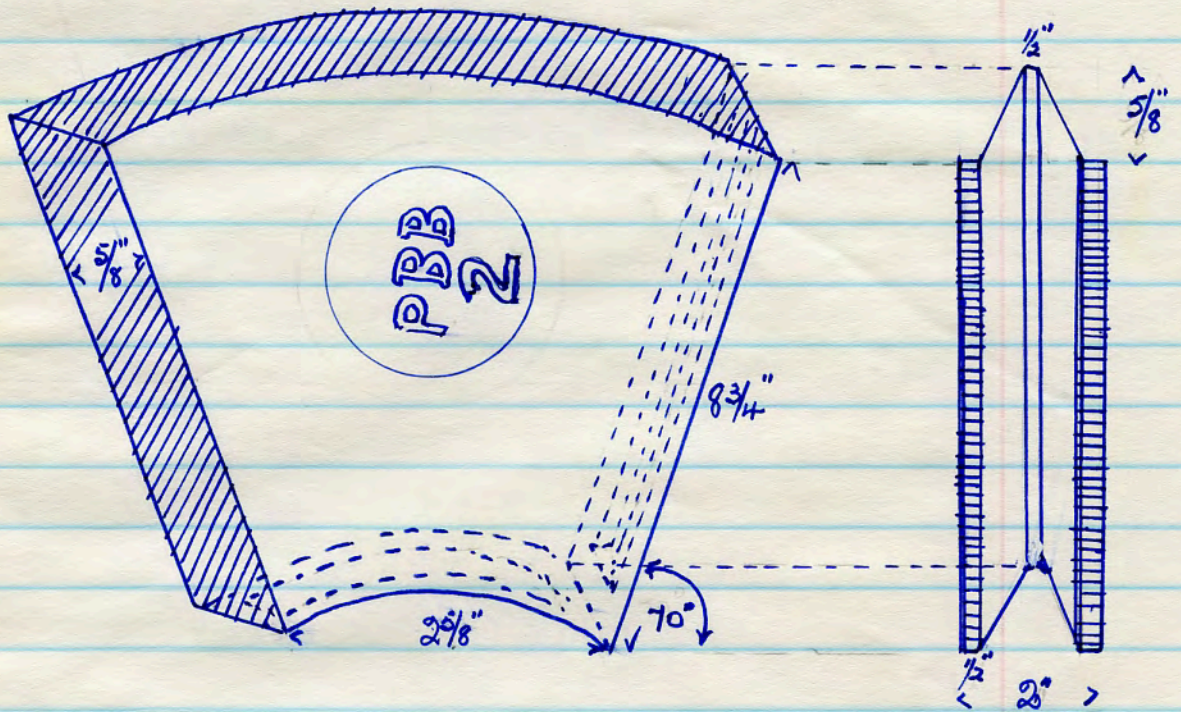

4004

No name
75 NA
scribed
red T.C.
11 lbs.

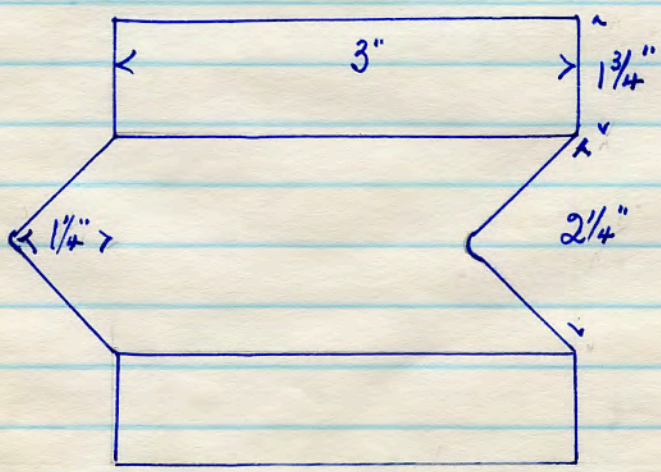

Stamped J I
(name of mouldset)

Acfton Mori dem. site 20. 10. '88

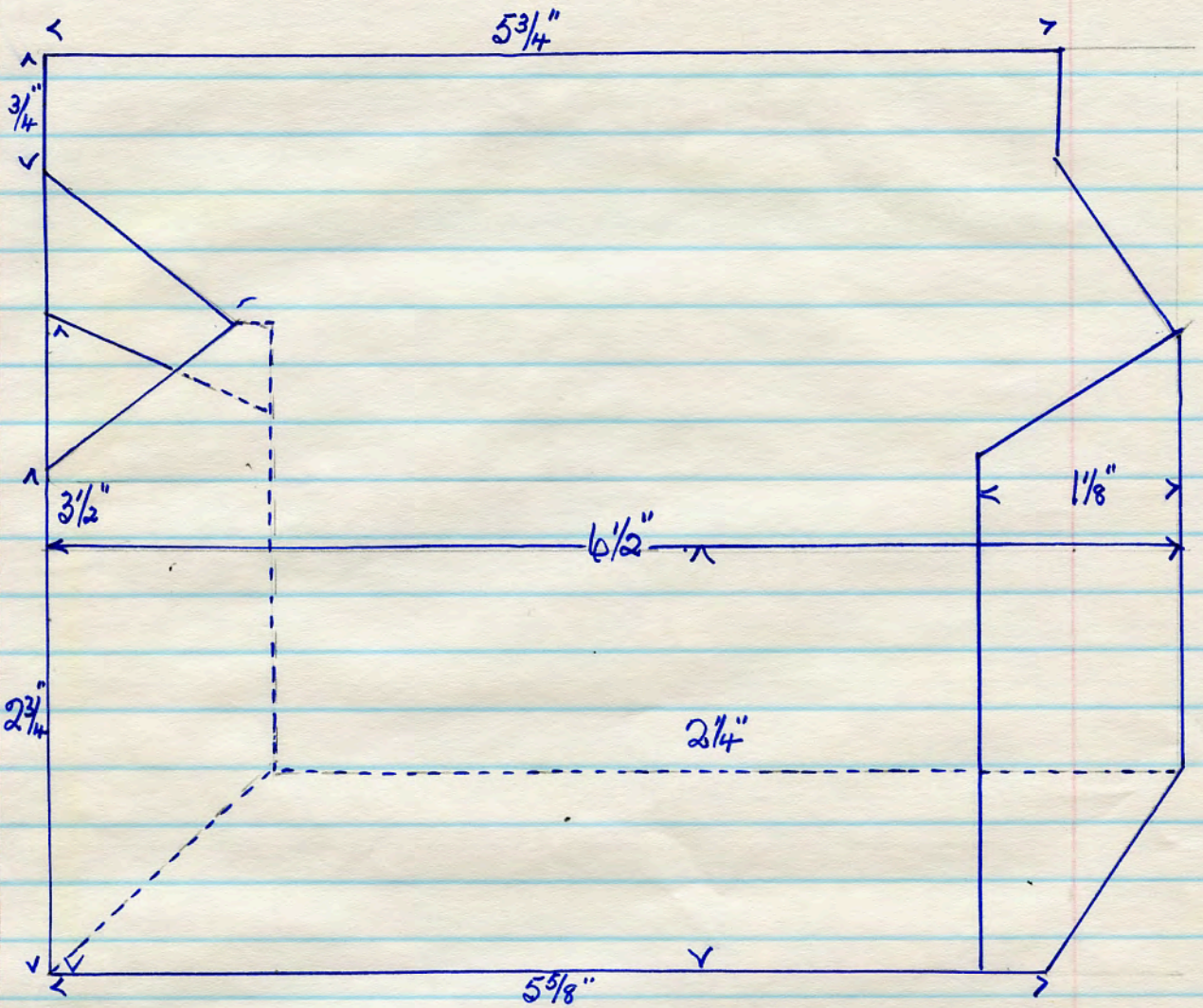

4005

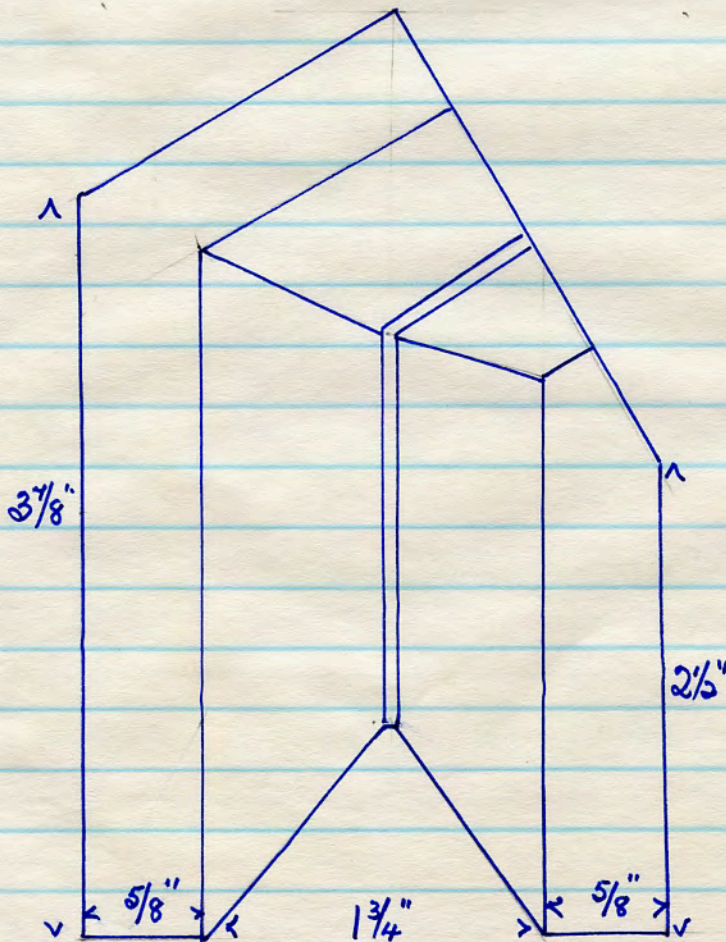

No name. 43 N
 545 X
 scribed
 red T.C. 6 lbs.

No name. 893T. part of red T.C. drainage tile 8 lbs.

7" x 4" x 1 7/8"



4006

3"

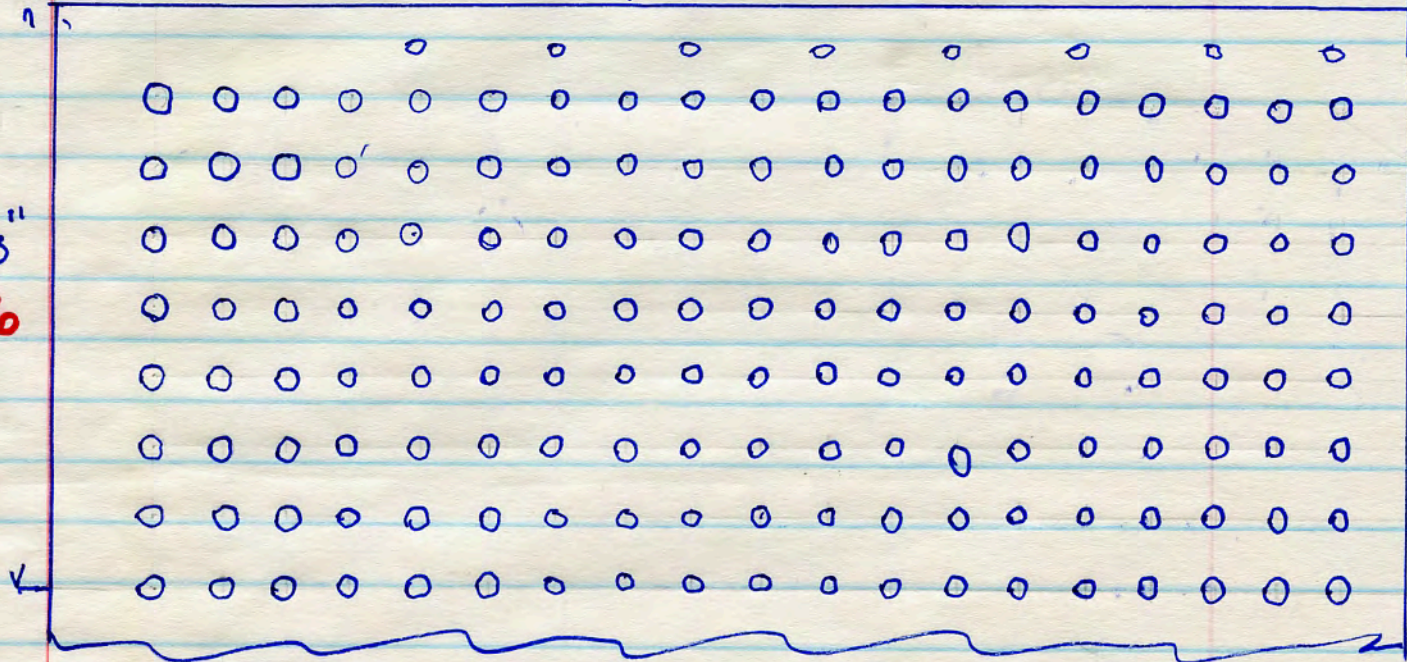

No name

09TA

red T.C.

18 lbs.

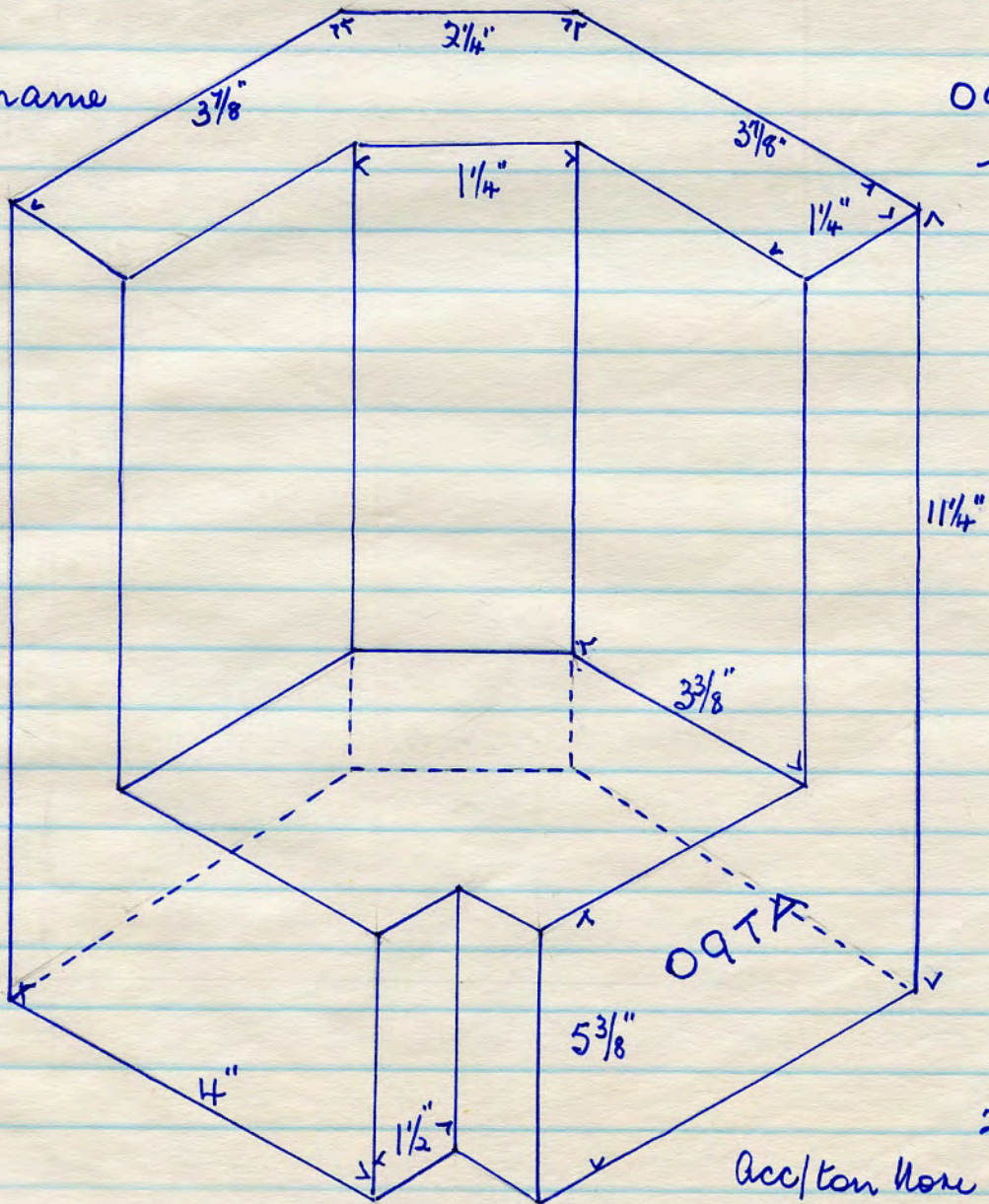

4007

20. 11. '88

Acc/ton. How dem. site

No name
RGA
red T.C
17 lbs

angle wall cap.

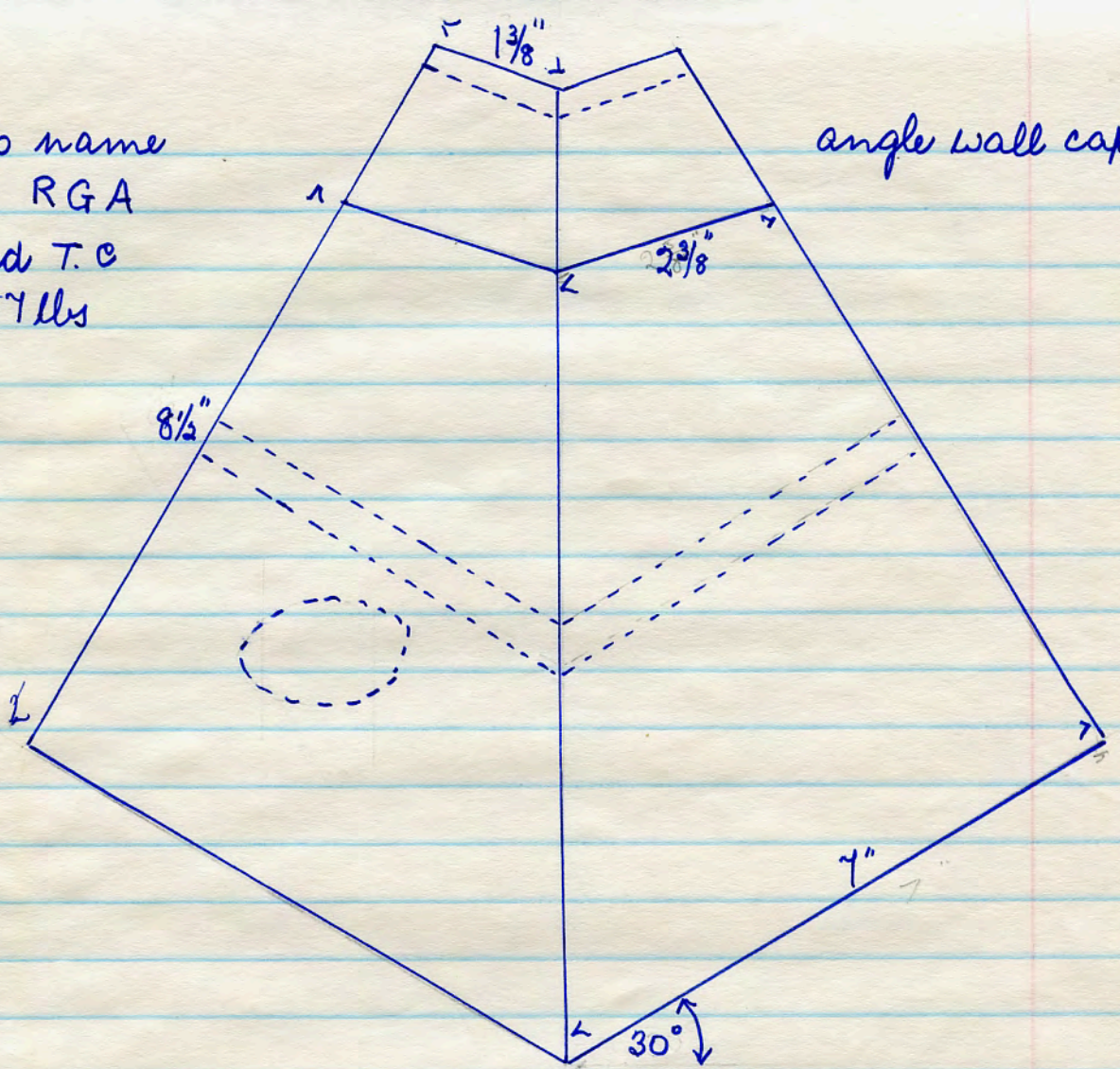

4008

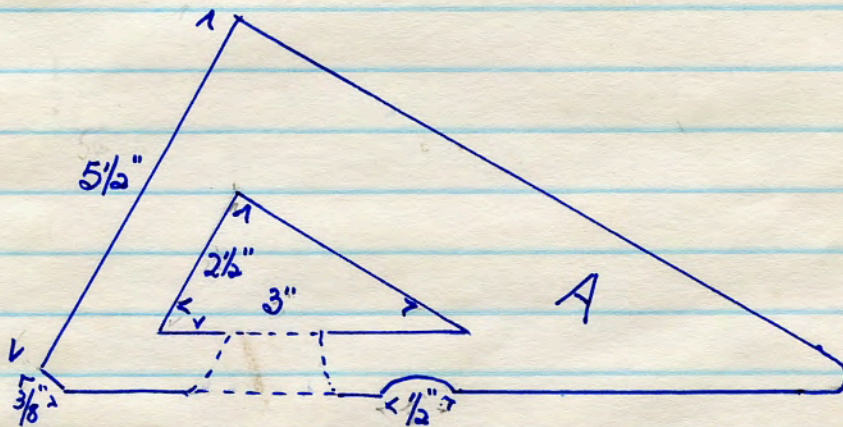

Acc/ton Mori dem. site 10. 11. '88

No name.
PN 5AE
red T.C.
10 lbs

4009

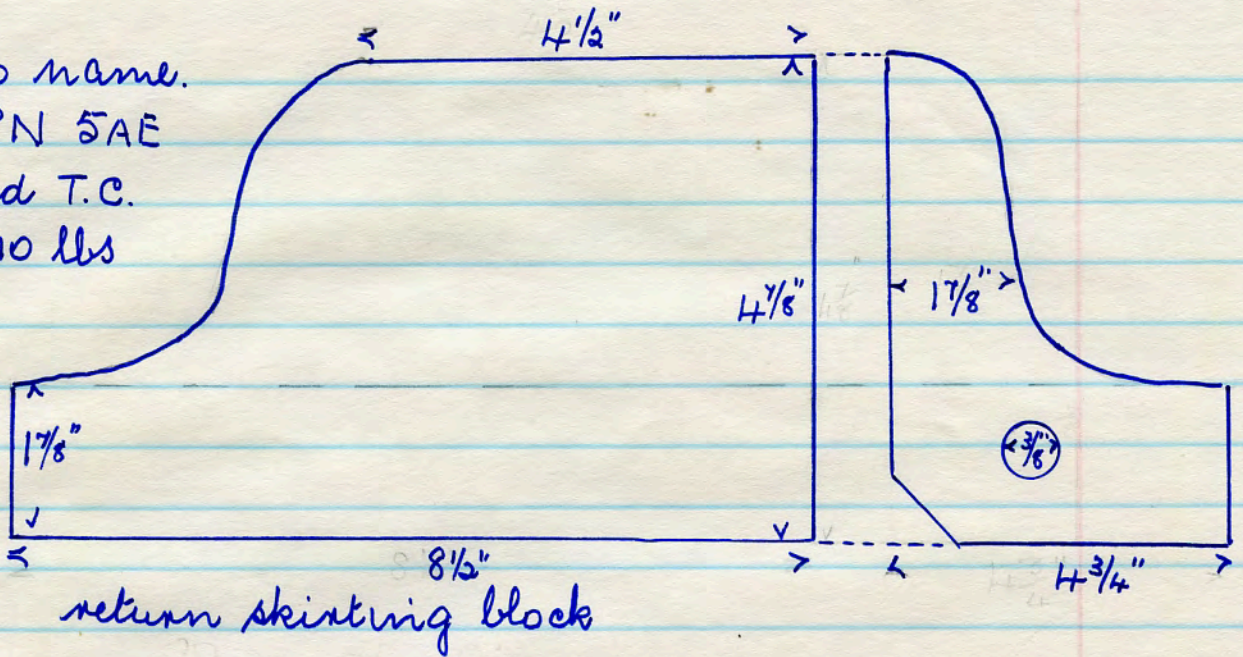

4010

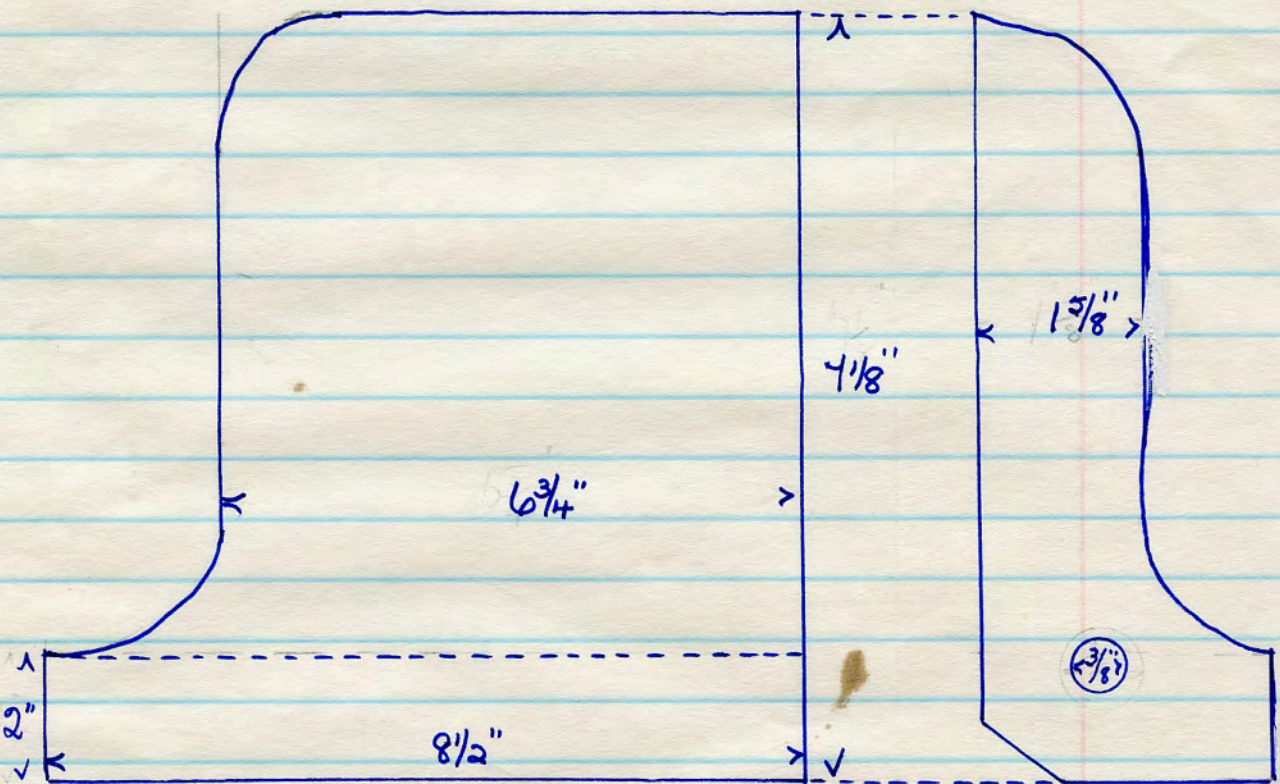

No name. 1QE red T.C. 12 1/2 lbs.
return skirting block.

Acc/ten Mori dem. site 10. 11. '88

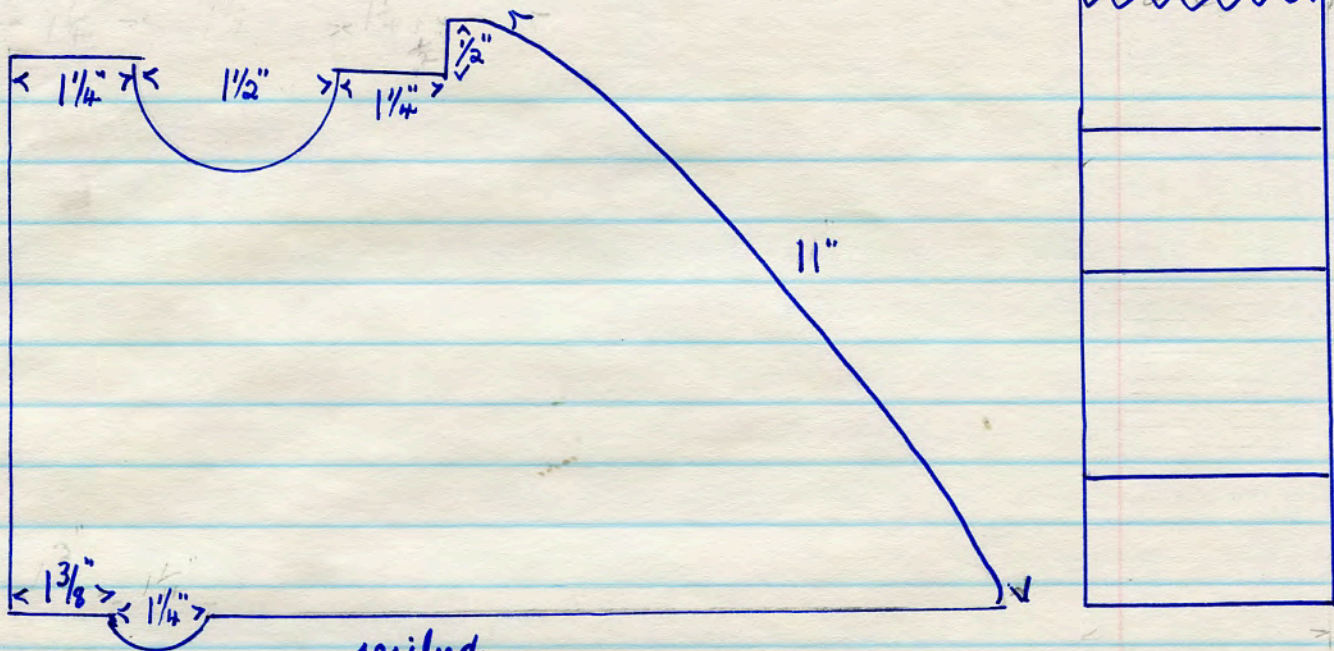

462 ✓
H011
 1-B
 welder

scribed

No name. 462 V1. red T.C. 18 lbs.
 HB stamped (moulder).

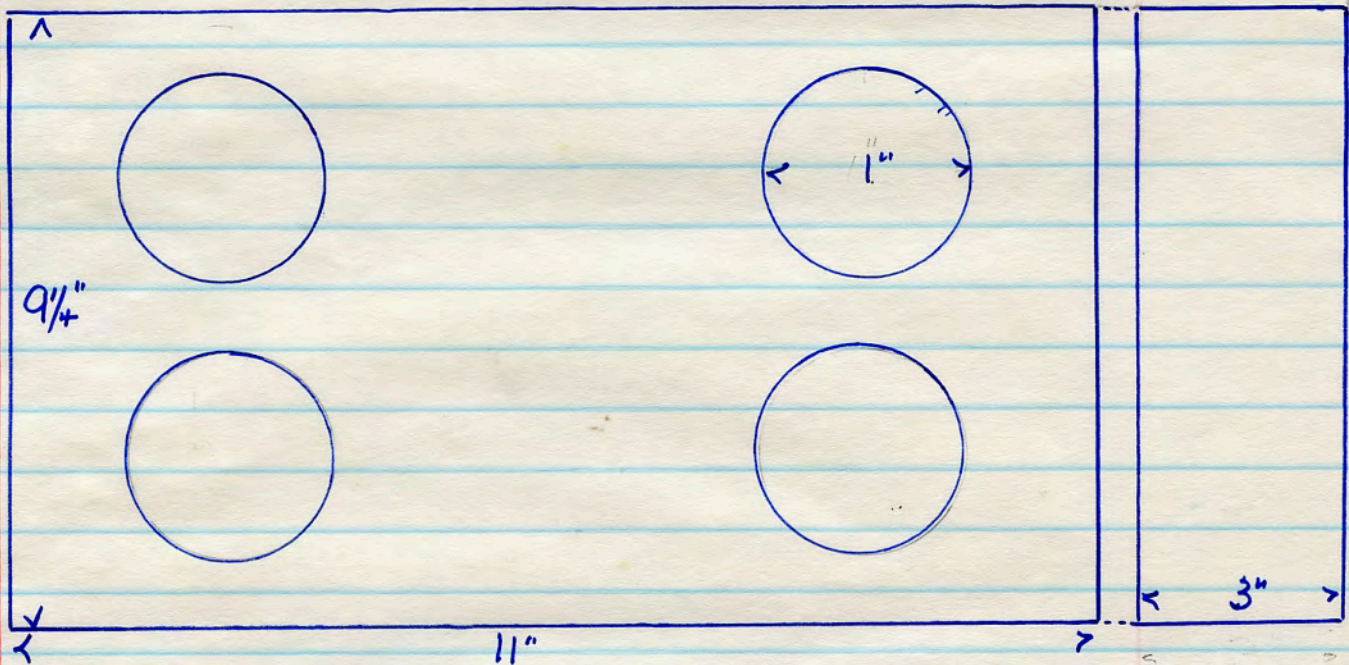

H012

No name. YWAA scribed red T.C. 18 lbs.
 4 x 1" perfs.
 Acc/ten Mori dem. Site 10. 11. 88

No name. 23G1 red T.C. 18 1/2 lbs.

TH stamped (moulder)

4013

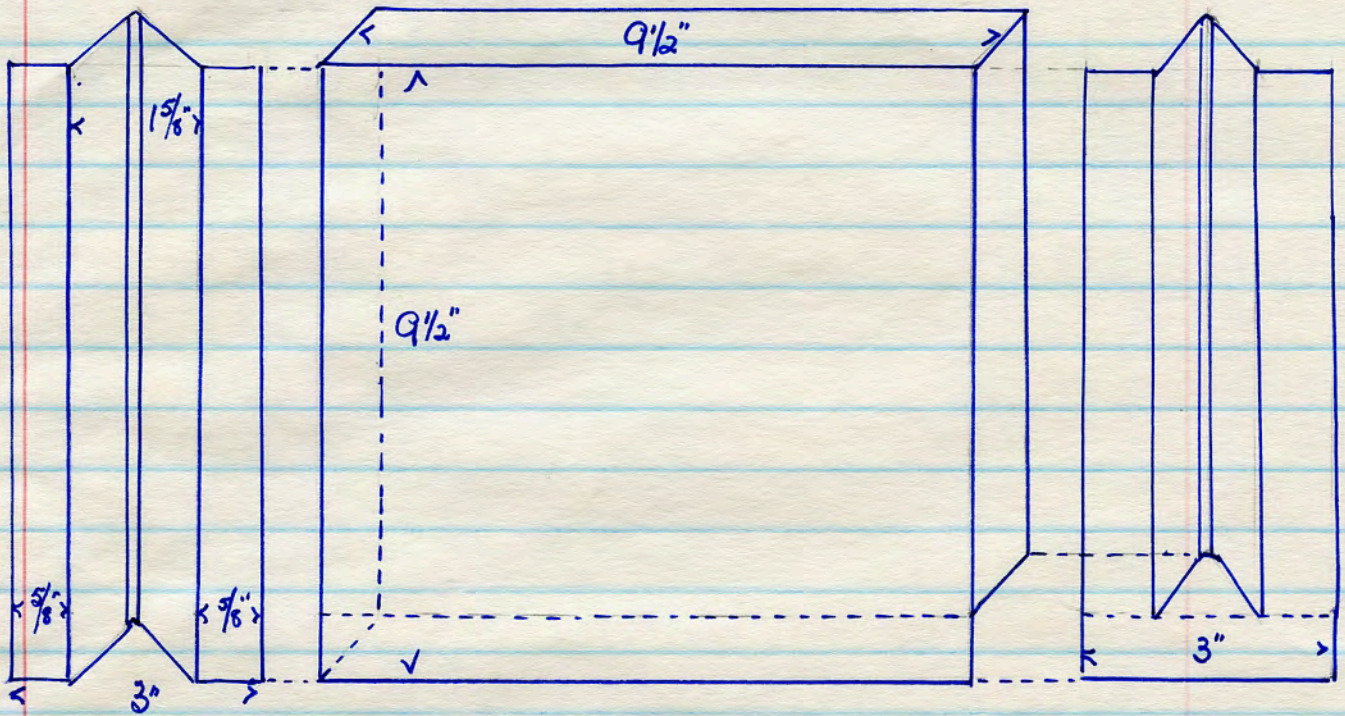

No name CP2 red T.C. 7 lbs.

4014

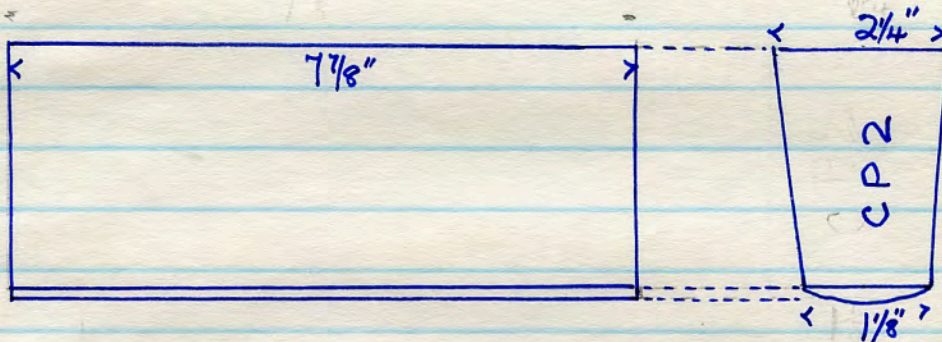

No name. 371 W 180 X red T.C. 6 lbs.

header to 3989

4015

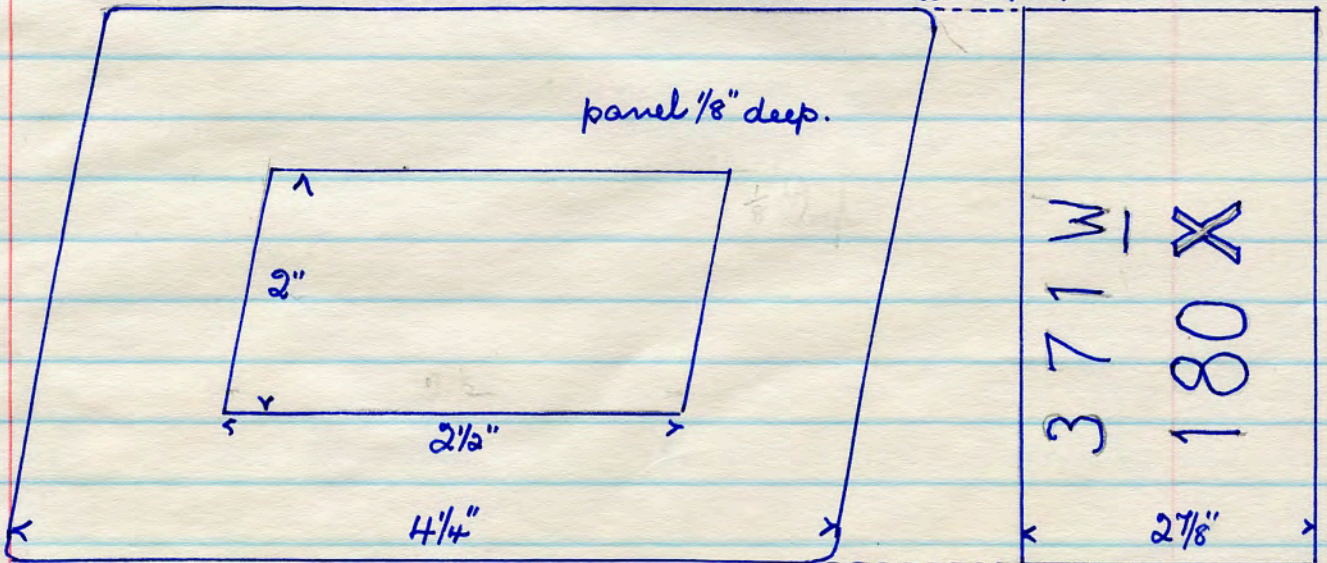

All from Auction Moni dem. Site 24. 11. 88.

4016

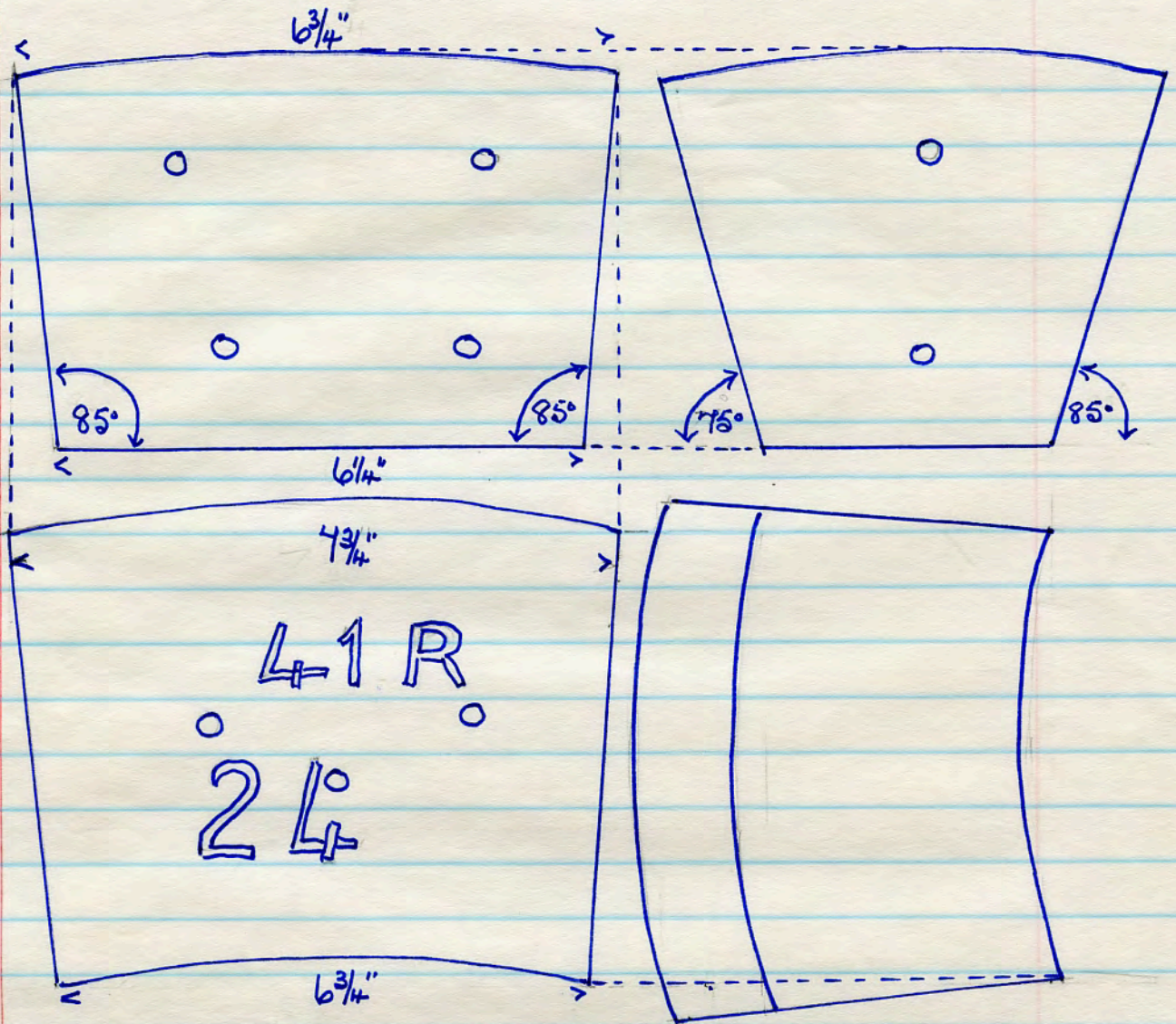

No name. 41R 24. red T.C. 16 lbs.

4017

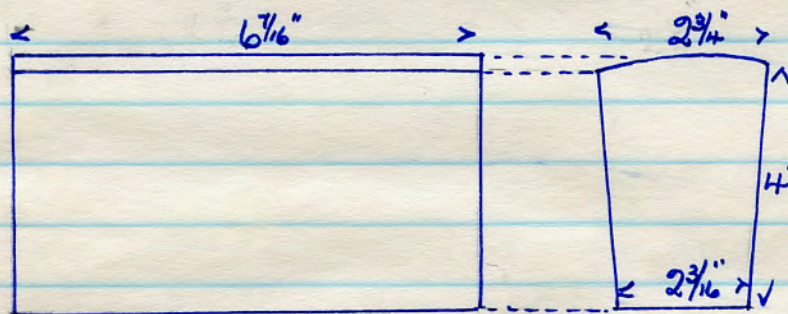

No name
53 OE
red T.C
6 3/4 lbs

No name. 19K H39 red T.C. 4 3/4 lbs

4018

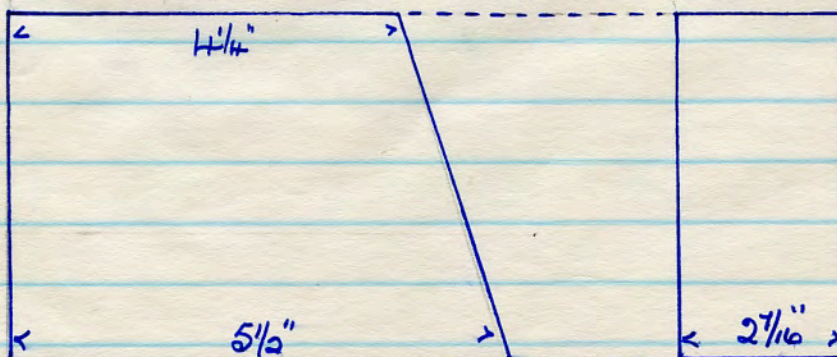

Acc/kon Mori dem. site 25. 11. '88

No name. 62 Q 12 red T.C. 9 3/4 lbs.

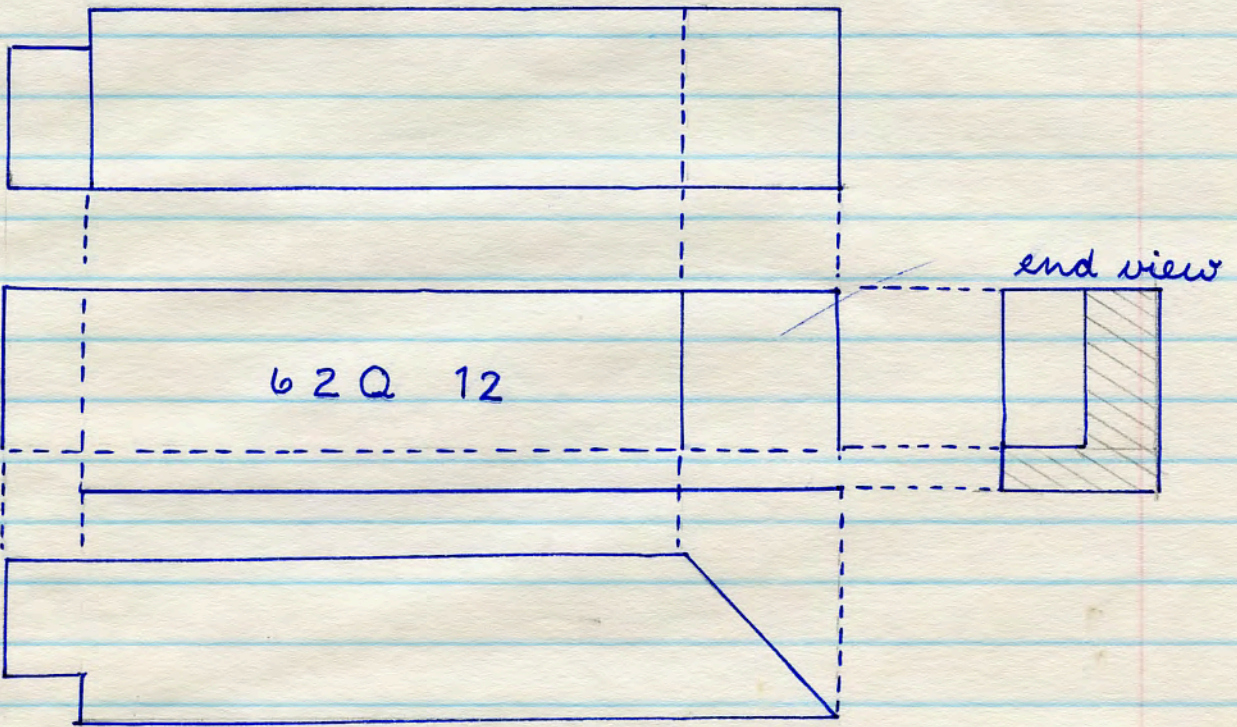

4019

No name C red T.C. 8 lbs.

6" x 6" moulded return. No 70 in sample book of
 Enfield Bks + Jena
 Cotha Co Ltd.

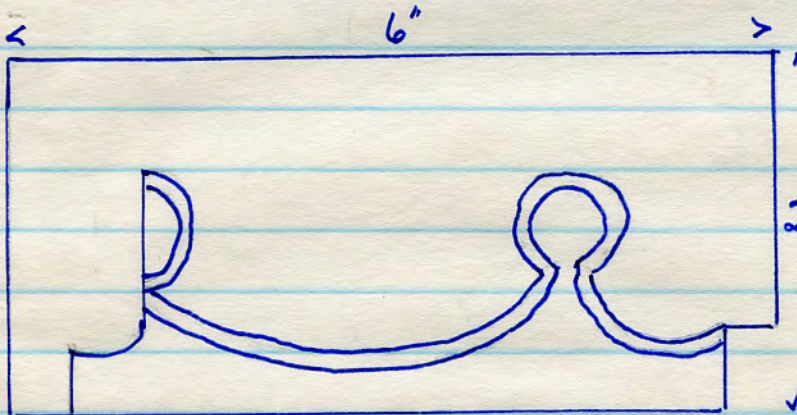

4020

Acc/ton.
 mould continues
 along this edge.

Acc/ton Noii dem. Site 25. 11. 88.

No name. 8N49. red T.C. 10 1/2 lbs.

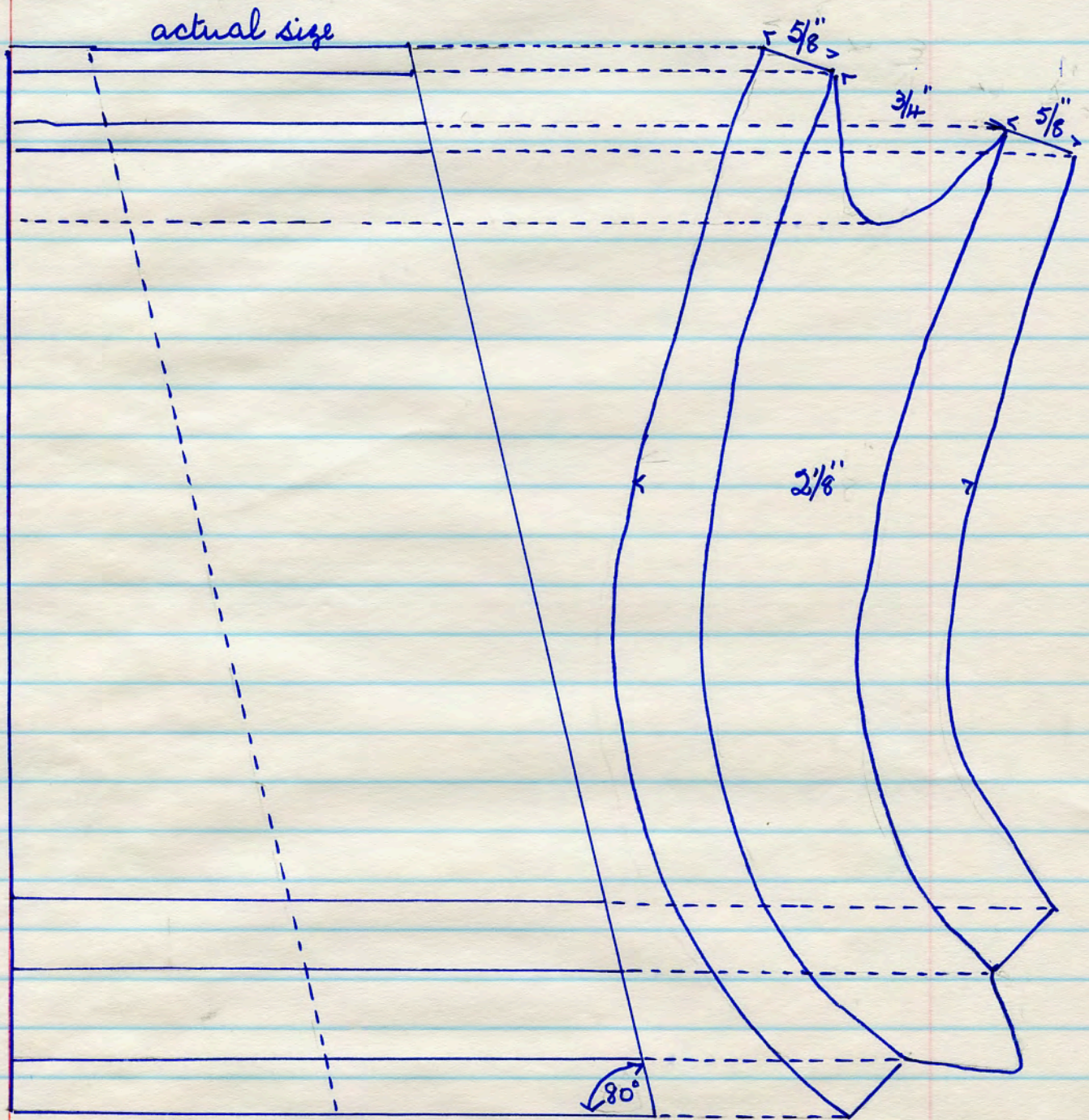

4021

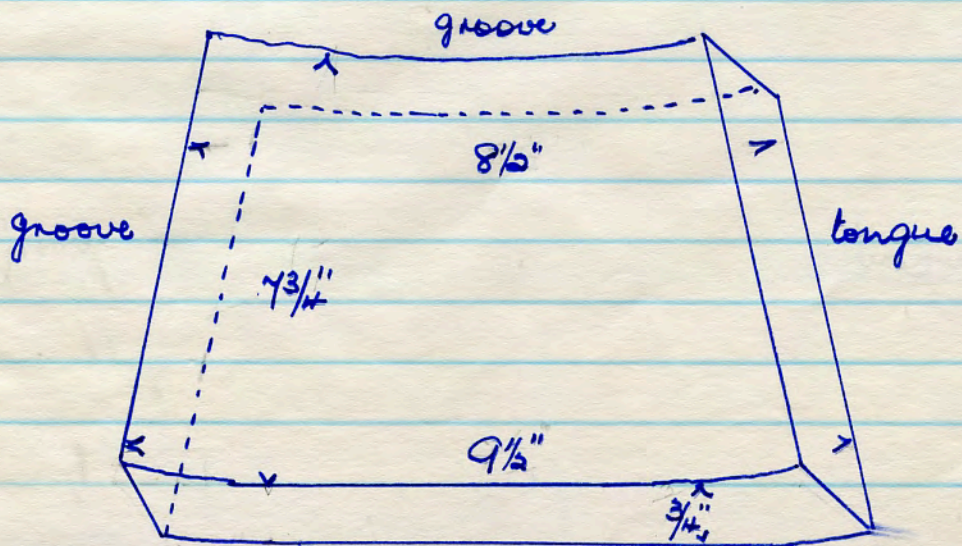

No name. INH red T.C. 7" x 7" x 3" decorative return
 11 1/2 lbs.

H022

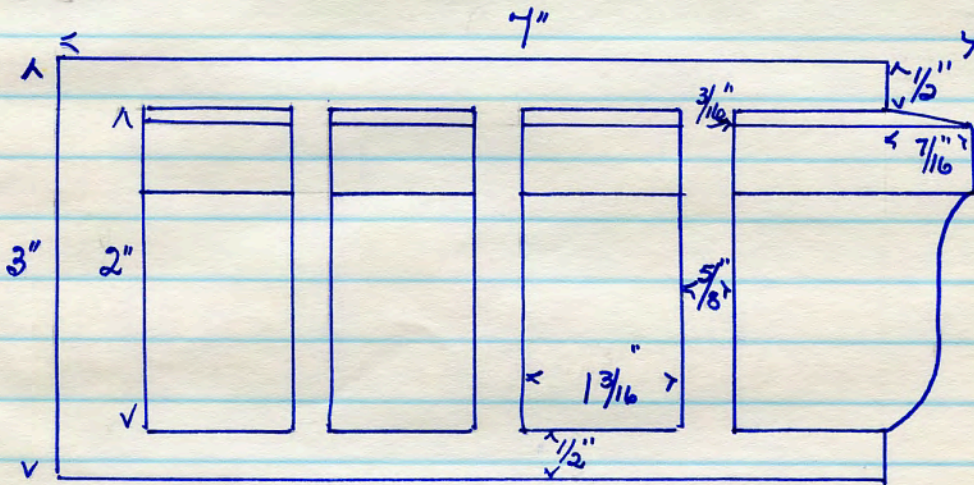

H023

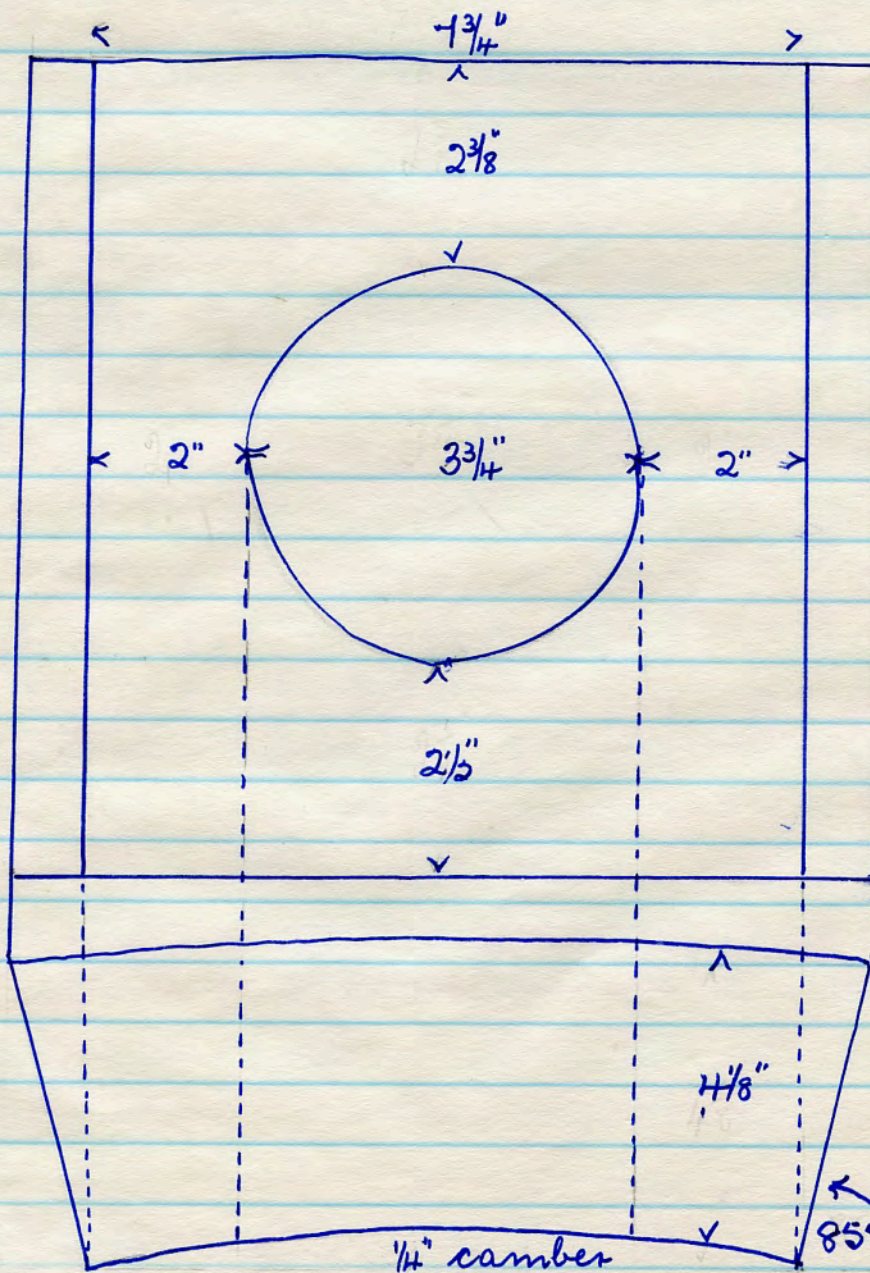

No name.
 46 R5
 red T.C.
 21 lbs.

Acc/ton Moni
 dem. site
 20. 10. '88

4024

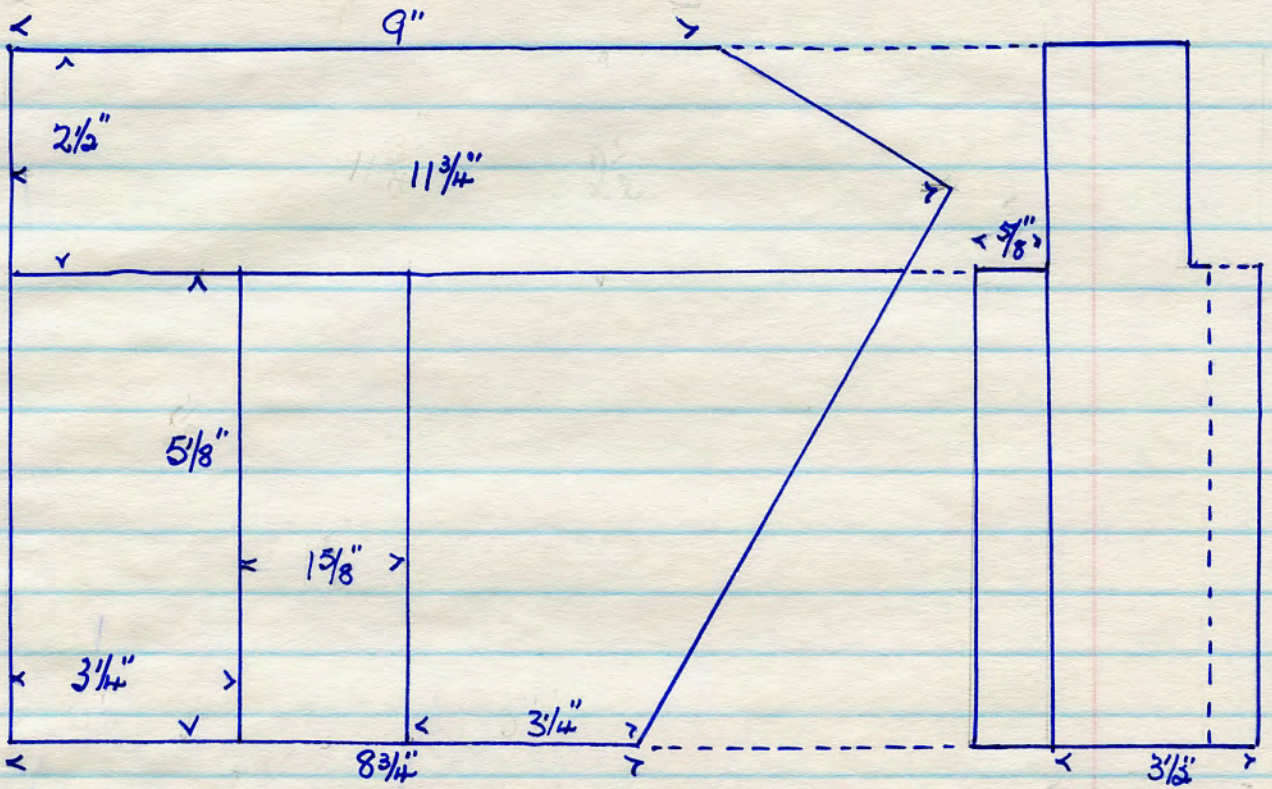

No name. 61 P 19 red T.C. 21 lbs.

4025

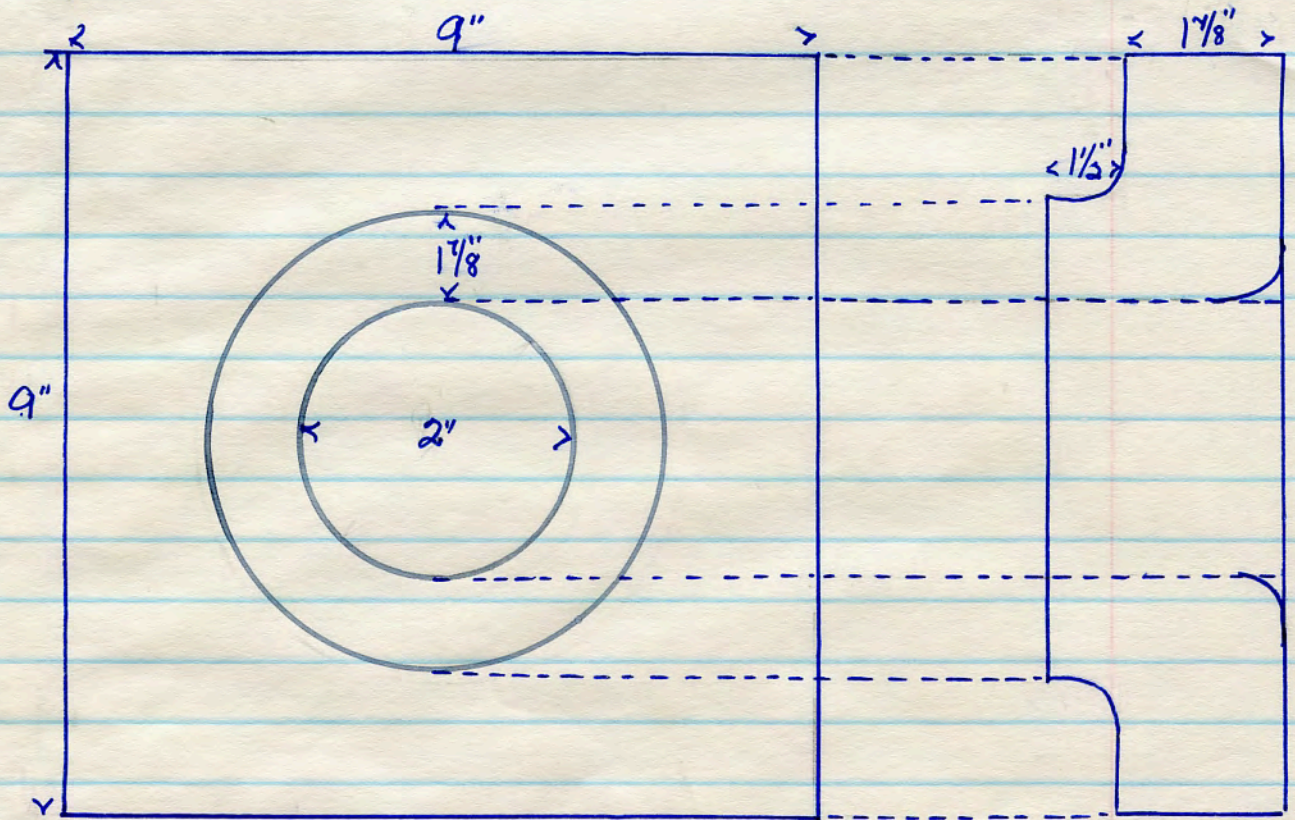

No name. 386 Y red T.C. 12 lbs.

Acfton Mexi dem. site 20. 10. '88

4026

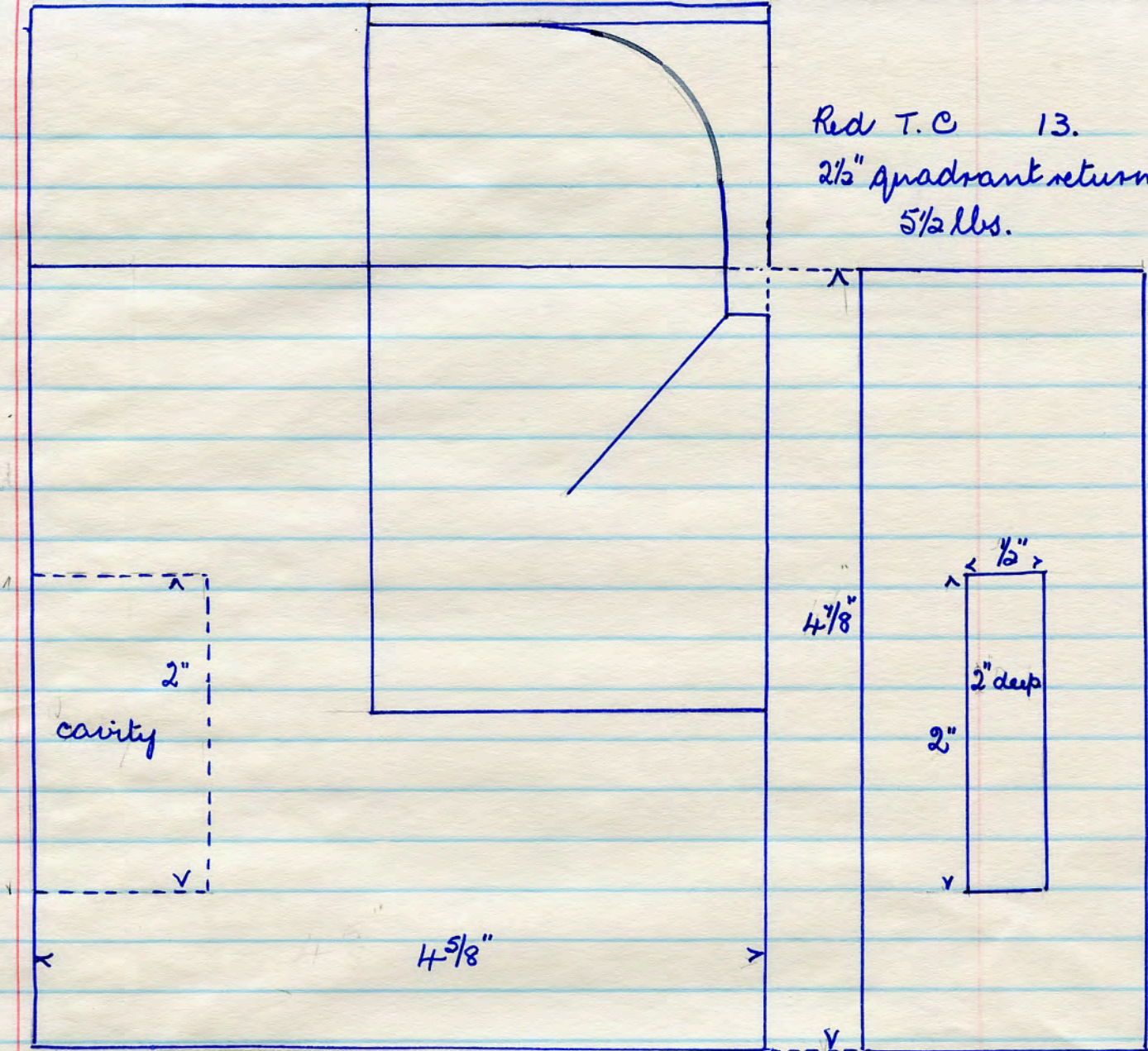

ACCRINGTON NORI BRICK & TILE CO LE stamped on rev.

4027

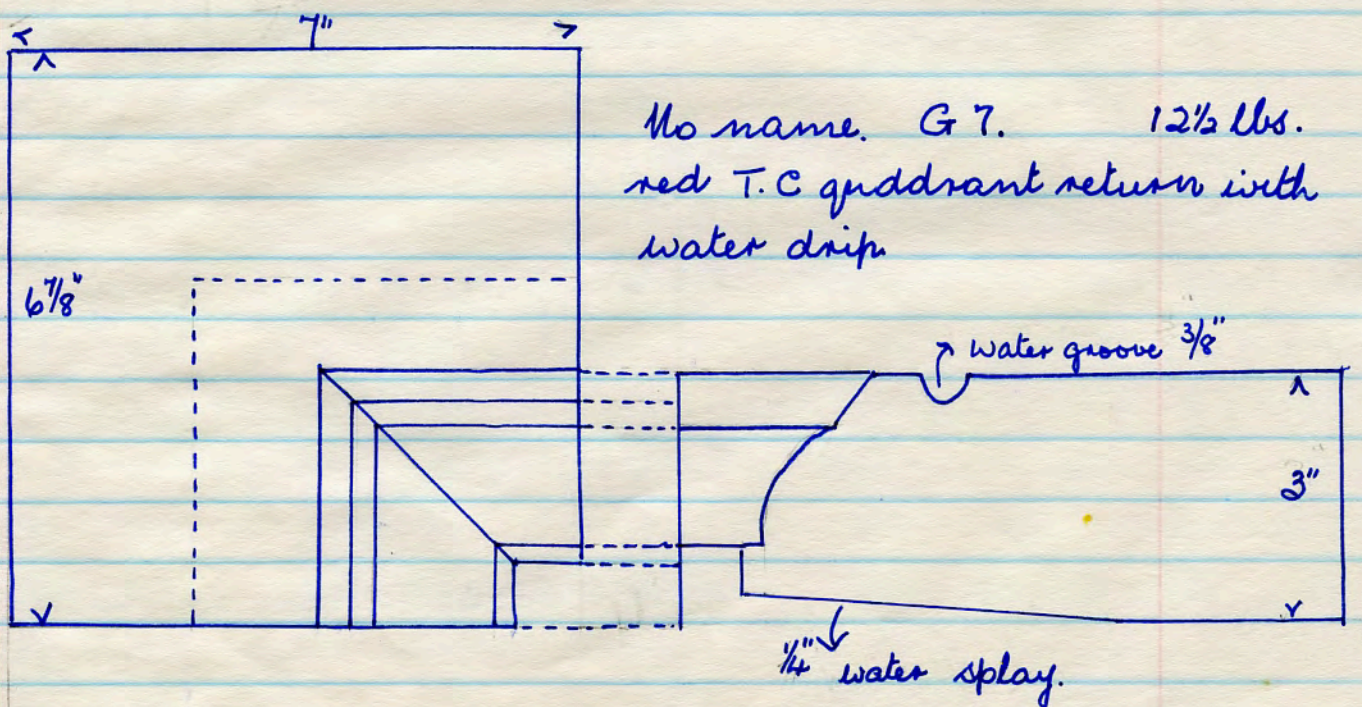

Accrington Nori. dem. site 25. 11. 88.

No name. red T.C nail head return 14 lbs.

4028

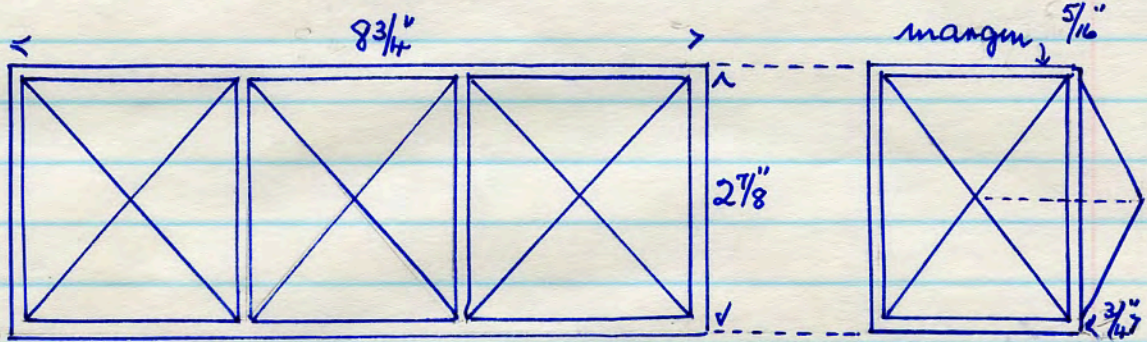

can be used for either hand.

No name. 23 G 15. red T.C.

4029

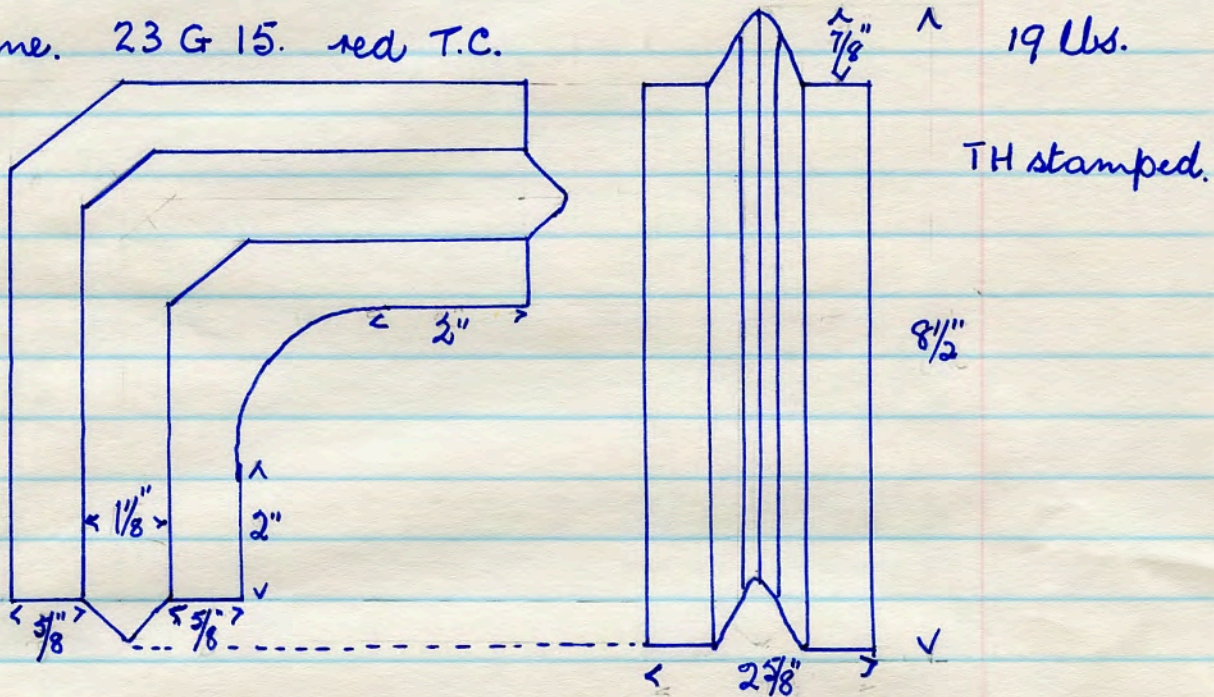

All from Acc/ton floor dem. site

No name. 427 UD red T.C. 10 lbs.

4030

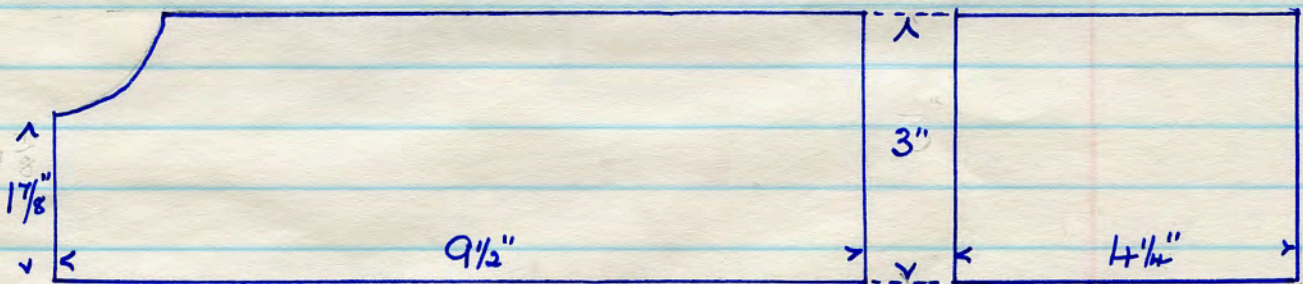

4031

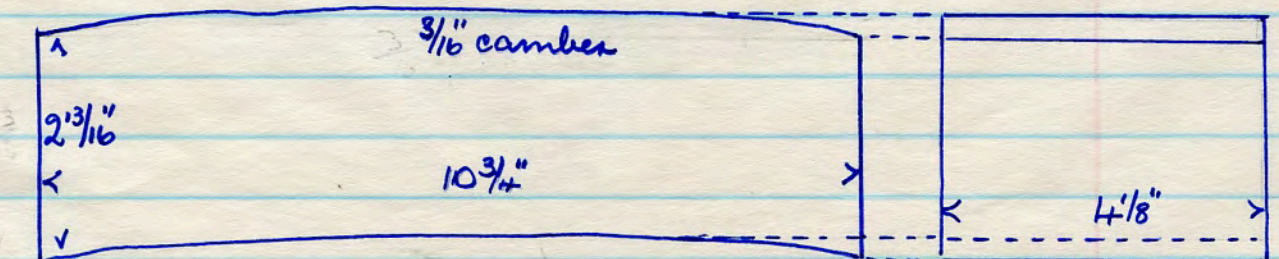

No name. 5R 16 red T.C. 13 lbs.

Name incised on base. red T.C. floor tile. 920 Y

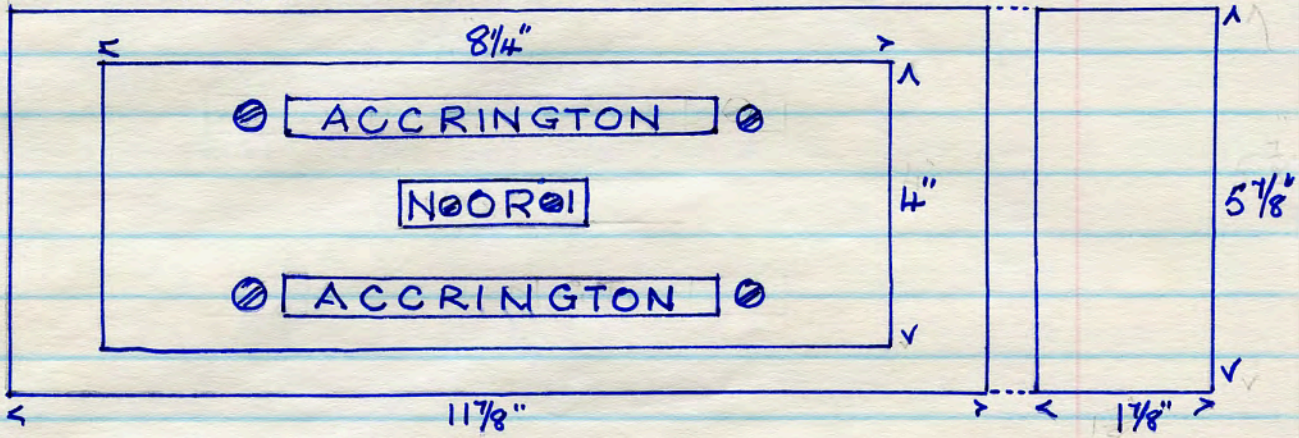

4032

plain surface obv.

11 7/8" x 5 7/8" x 1 7/8" 13 lbs.

Acc/Kon Moni dem. site 27. 11. 88.

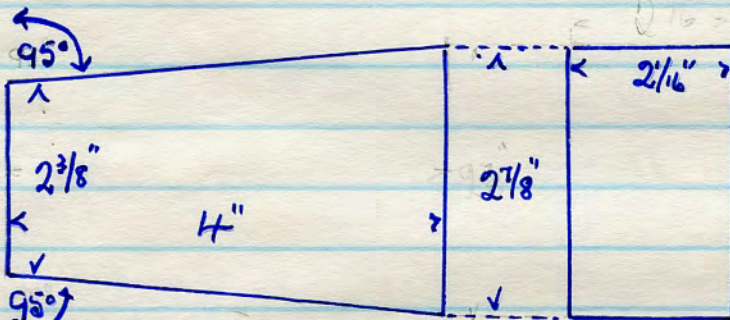

4033

No name. 42 RN
red T.C. 2 lbs.

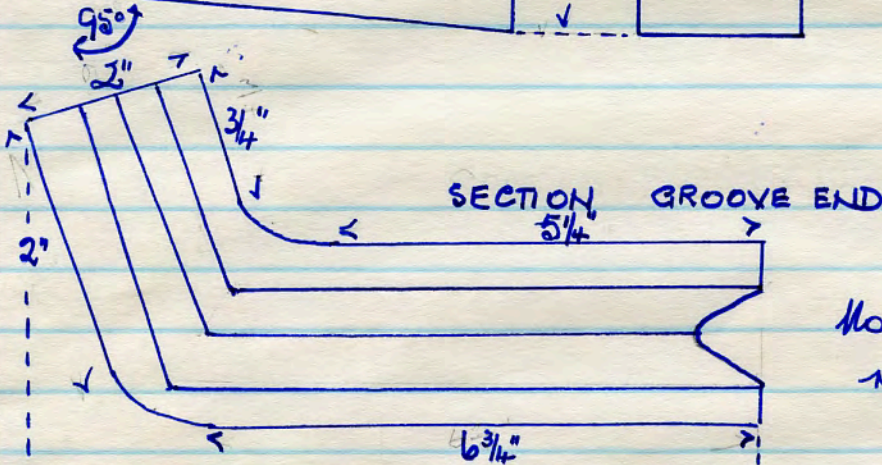

No name. 40 L8
red T.C. 9 lbs.

4034

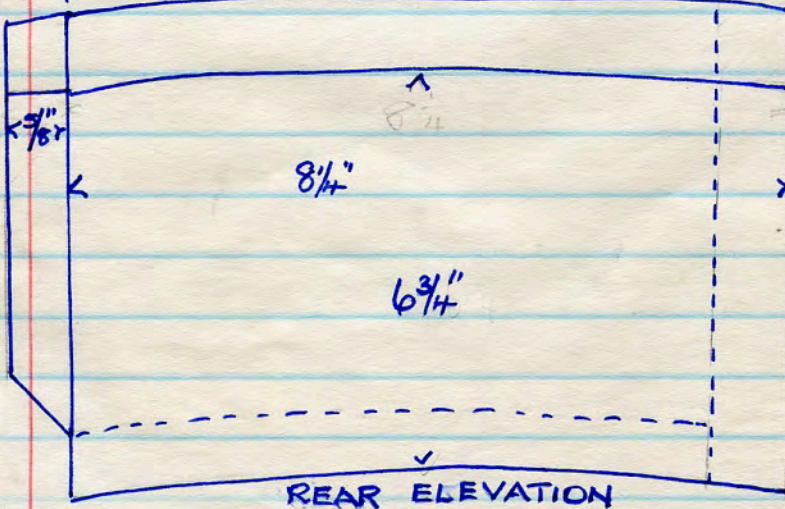

No name. no number red T.C. 11 lbs.

4035

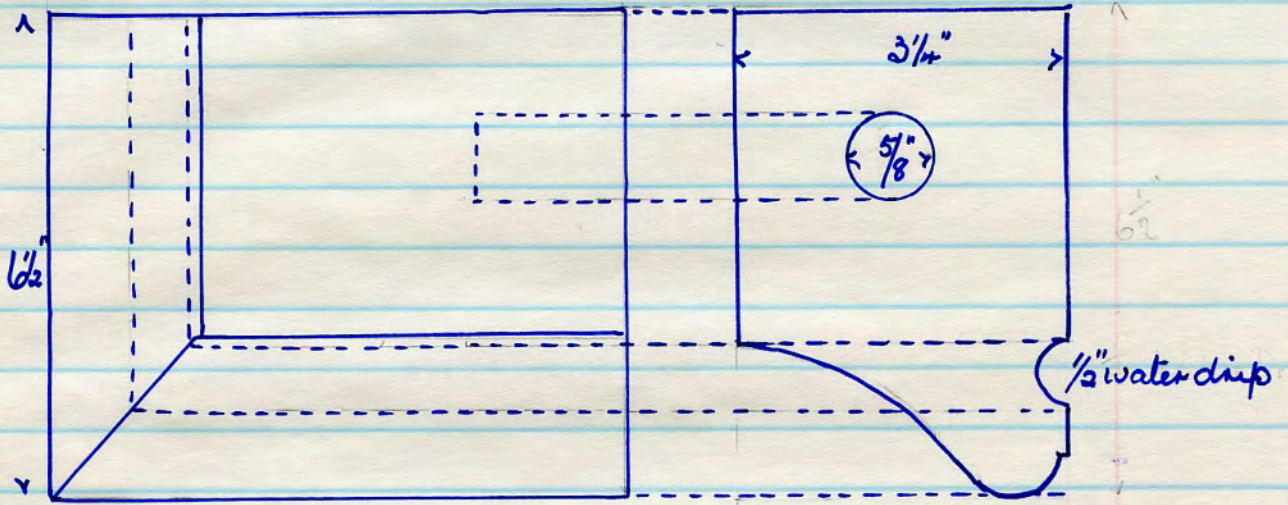

4036

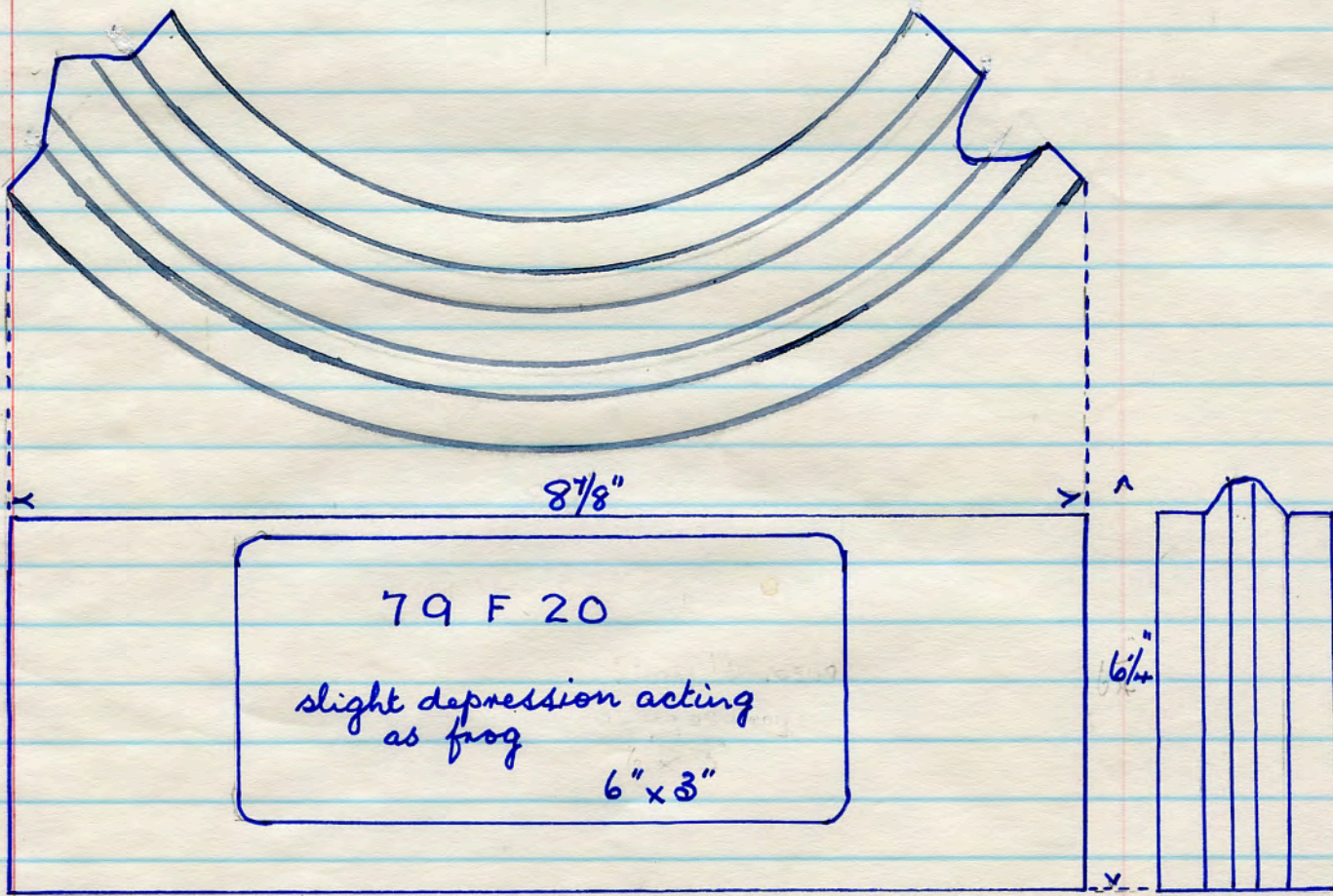

No name. 79 F 20 red T.C. 9 lbs.
Acceptor Mori dem. site 27. 11. 88.

4037

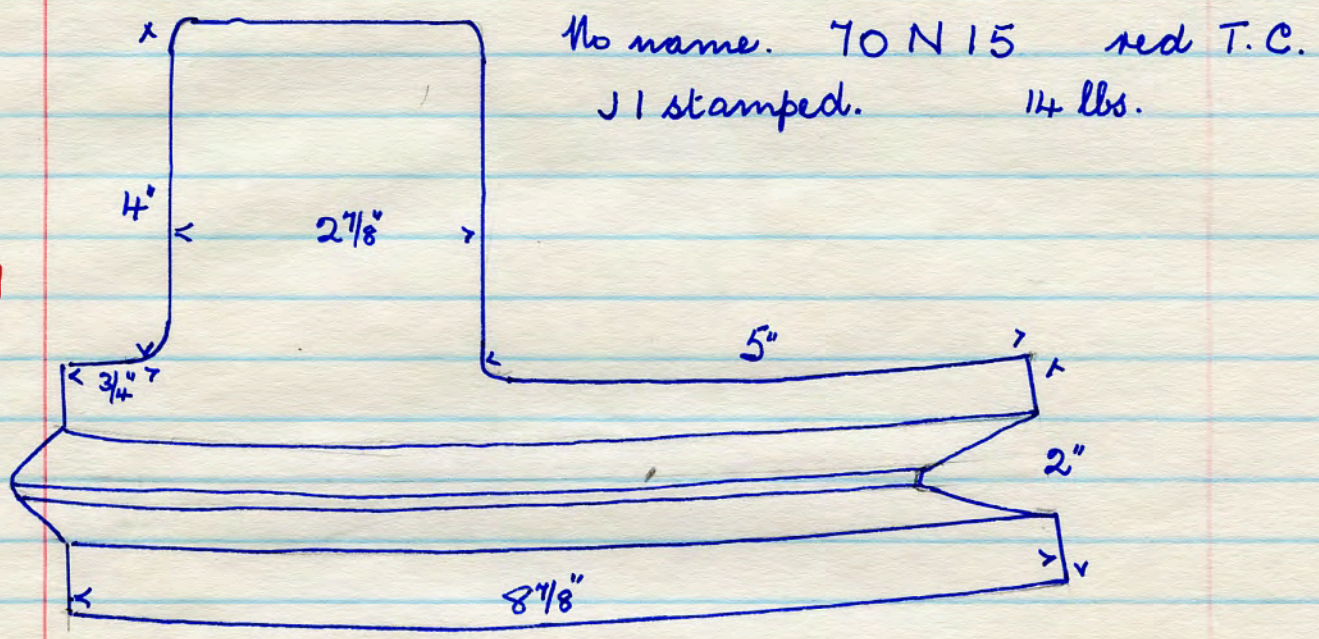

4038

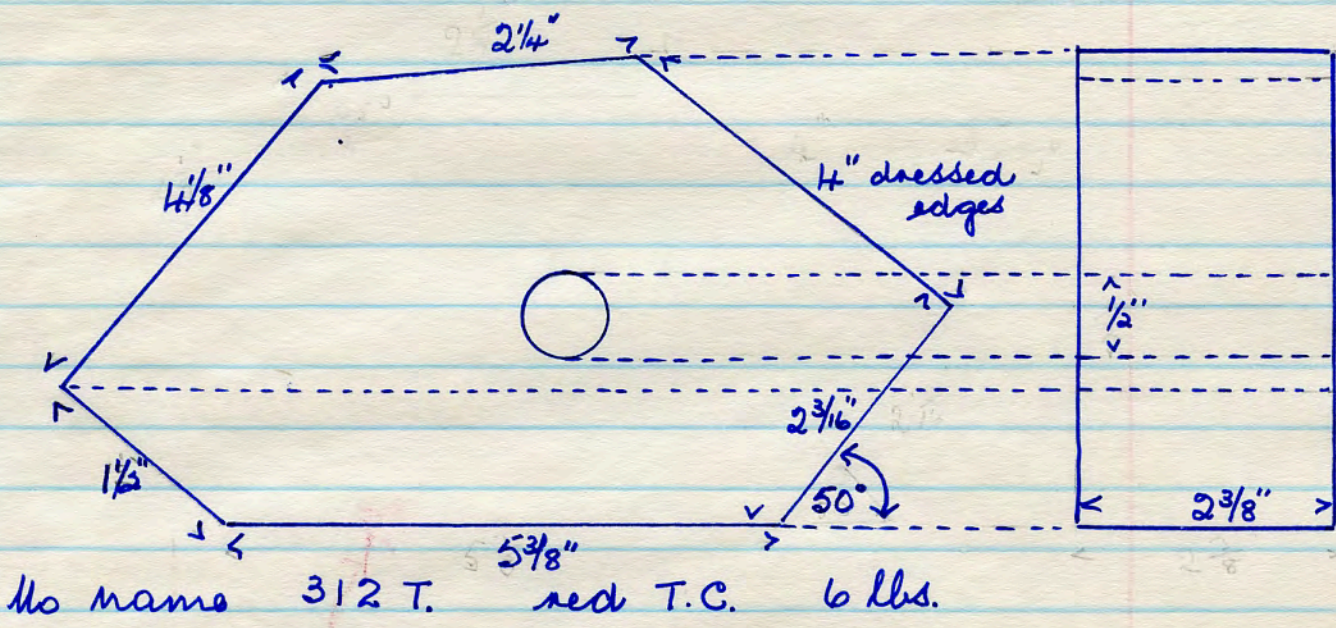

4039

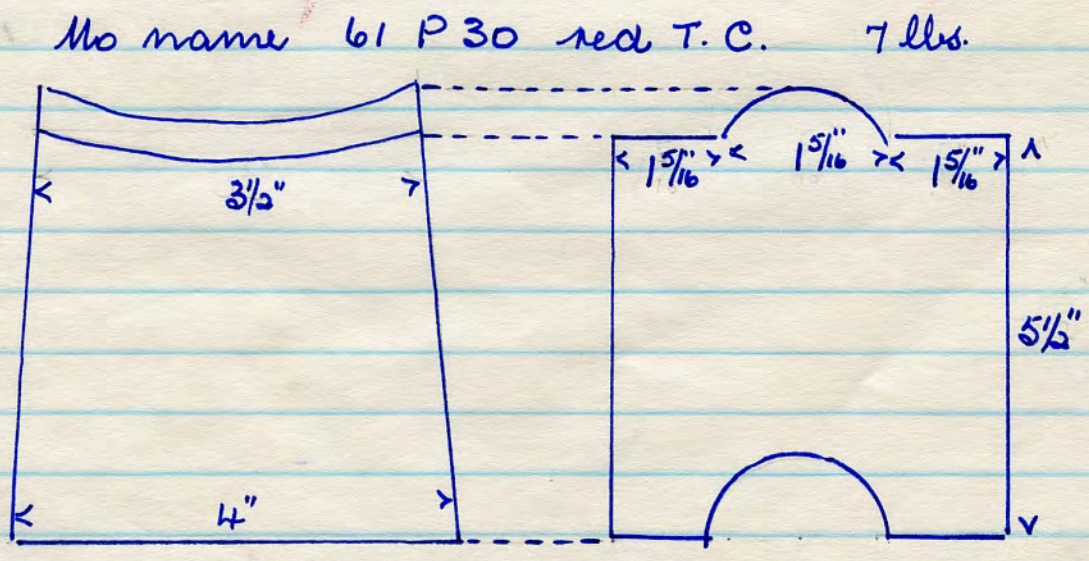

Acc/Kon Mori dem. site 27. 11. 88.

No name 29 P 175. red T.C. 5 lbs.

$\frac{3}{16}$ " camber

4040

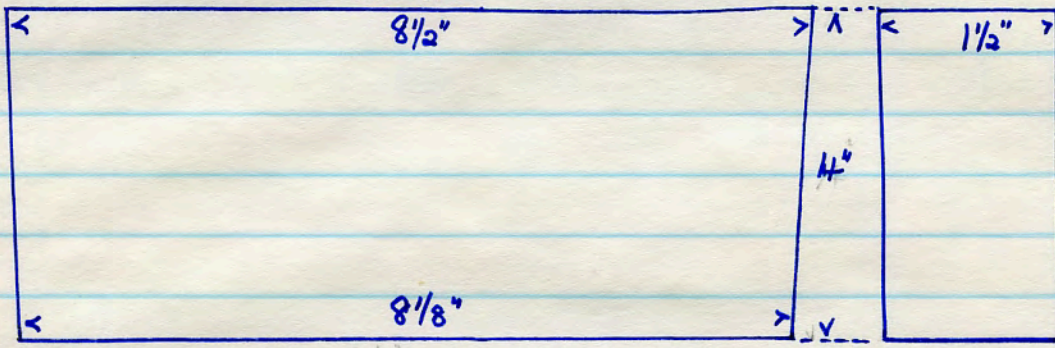

No name 380 VA
red T.C. 32 lbs.

4041

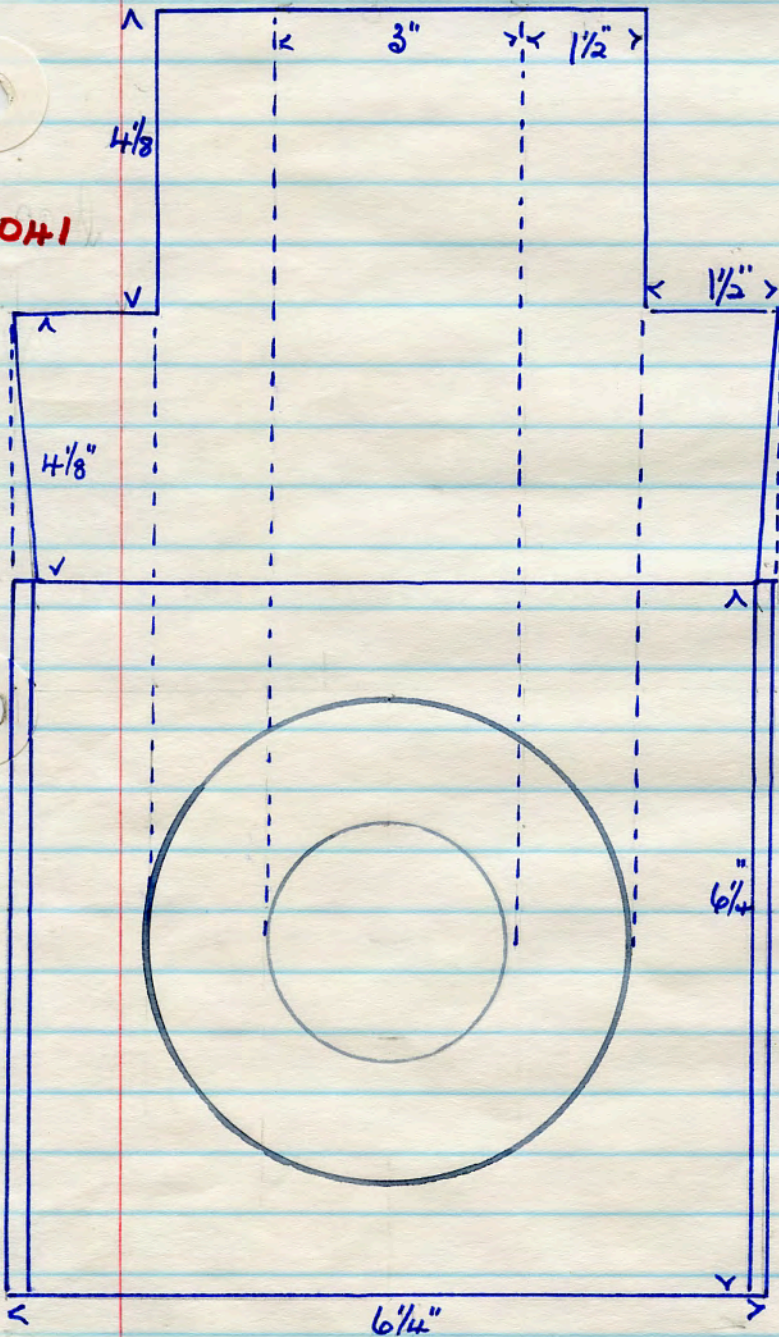

Acceptor Mori dem. site 28. 10. '88

No name. 43N 546 red T.C. 9 1/2 lbs.

4042

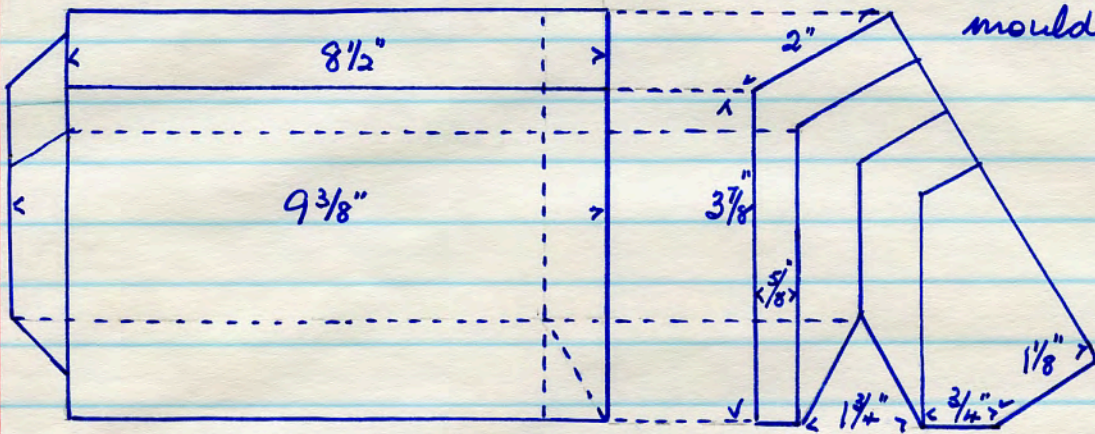

moulder's mark ✓

end view

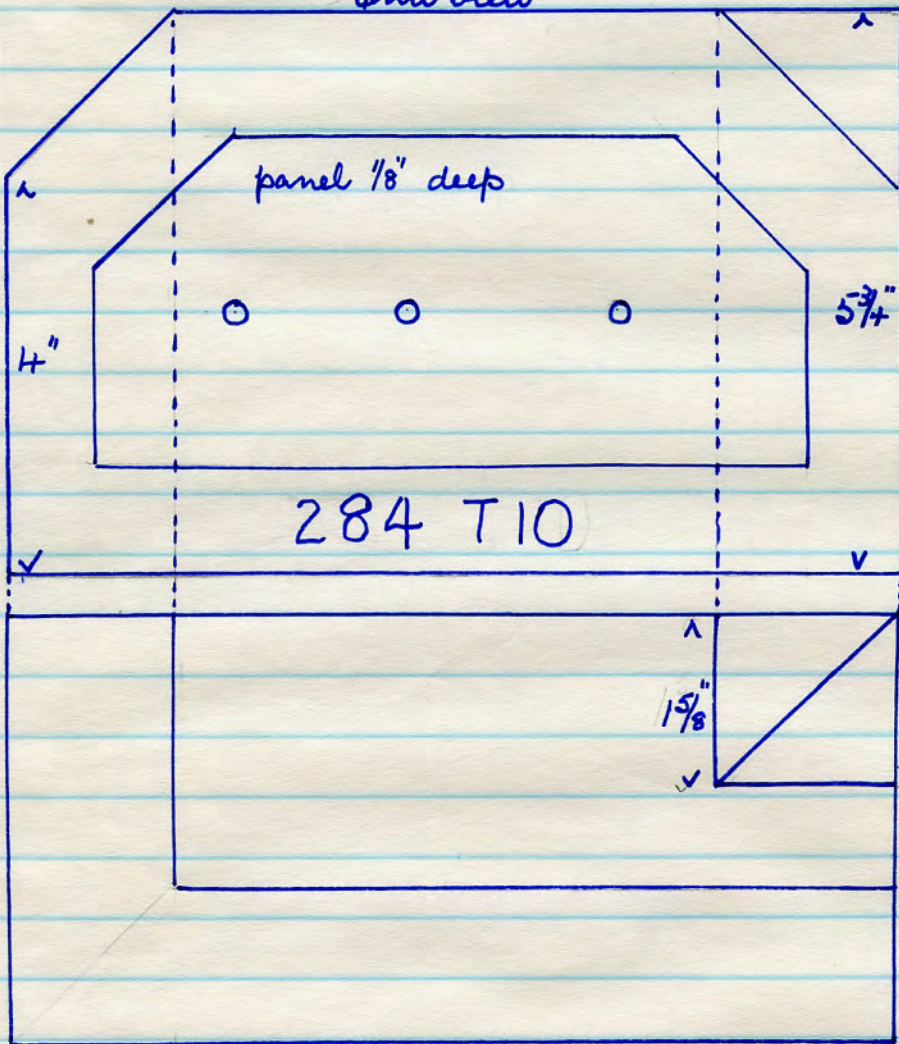

No name
284 T10
red T.C.
27 lbs.

4043

return for
wall coping.

plan - shortened version

Size over all. 8 3/8" square

Accpton Maxi dem. site 29. 11. 88.

4044

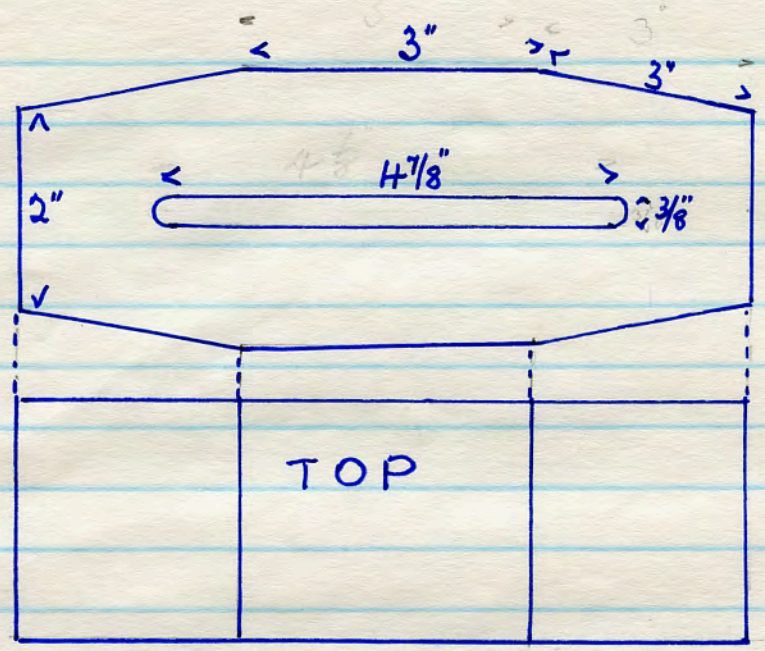

section

No name
no number
red T.C. 22 lbs

4045

No name 38 lbs.
55 N 2
red T.C.

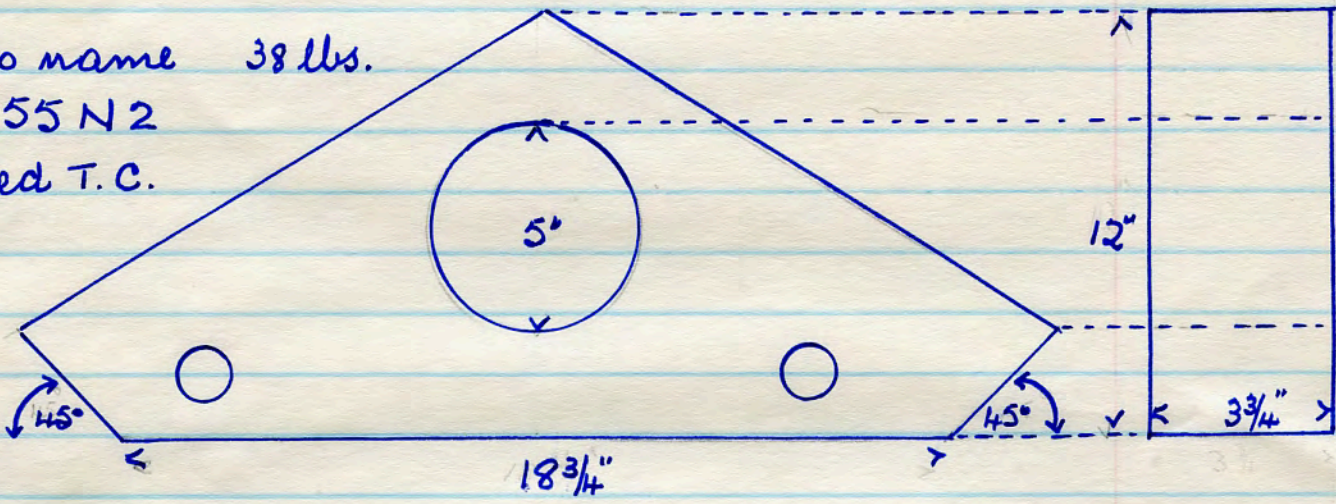

moulder's stamp HB.

4046

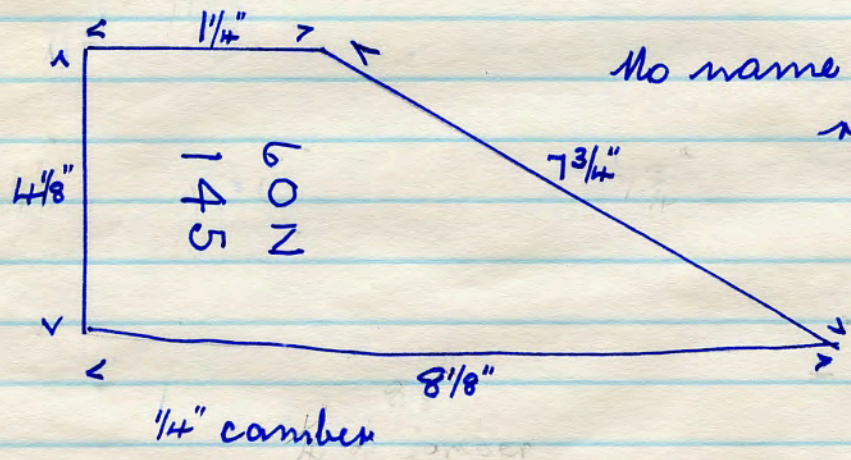

No name 60 N 145
red T.C. 6 lbs.

Acc/Kon Masi dem. site 29. 11. 88.

4047

No name 96 C 11 red T.C. 8 lbs.

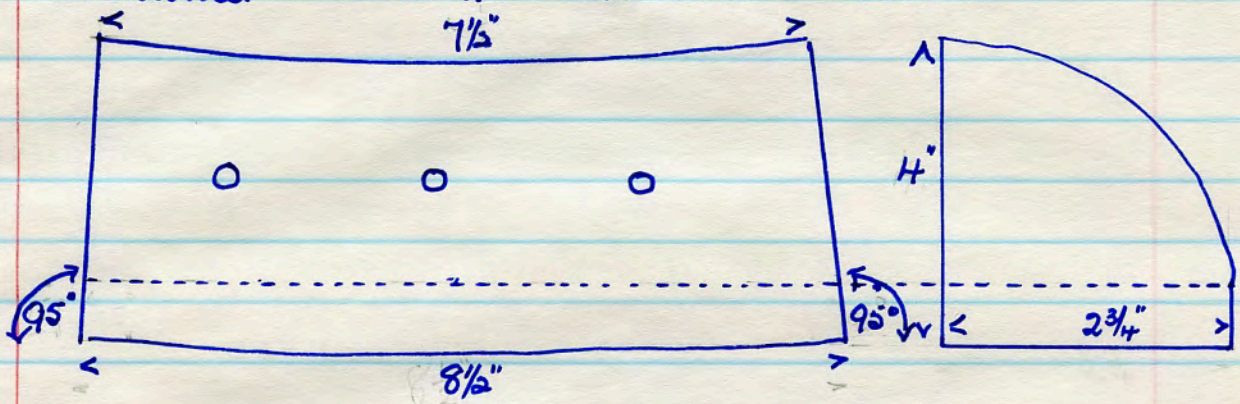

4048

No name 25 K 8 red T.C. 12 lbs

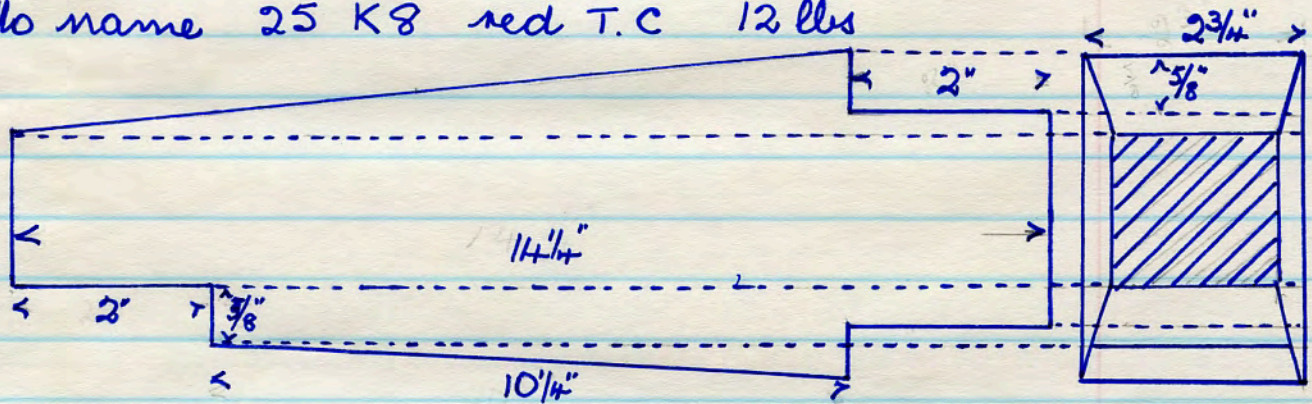

HP moulder's stamp.

4049

No name 815 VB. red T.C. 13 lbs.

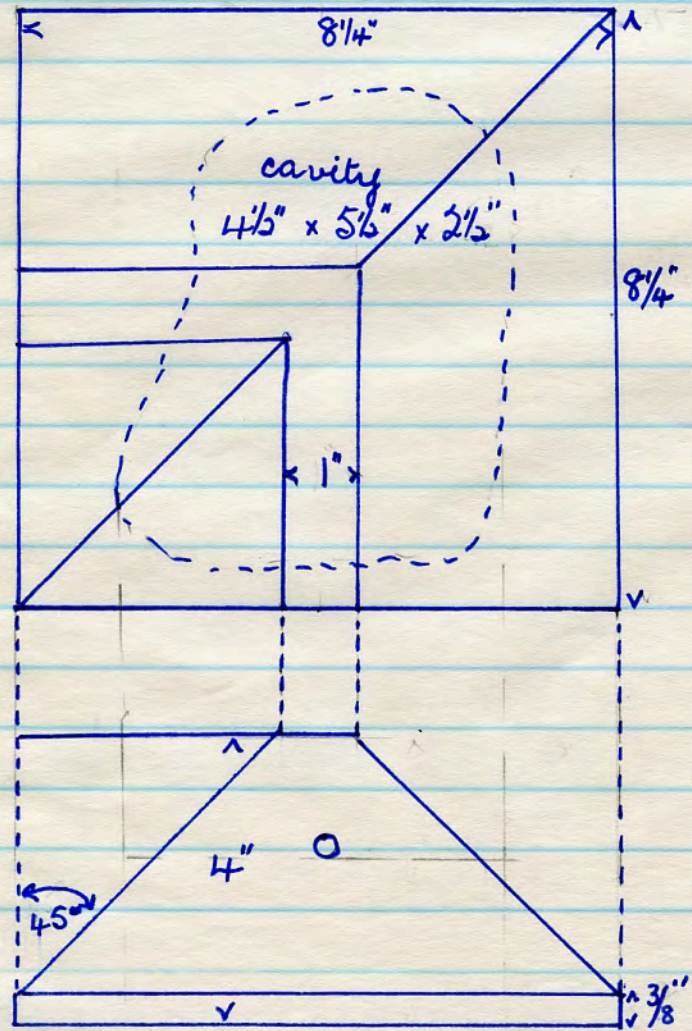

Acfton Harri dem. site
29. 11. 88.

actual size

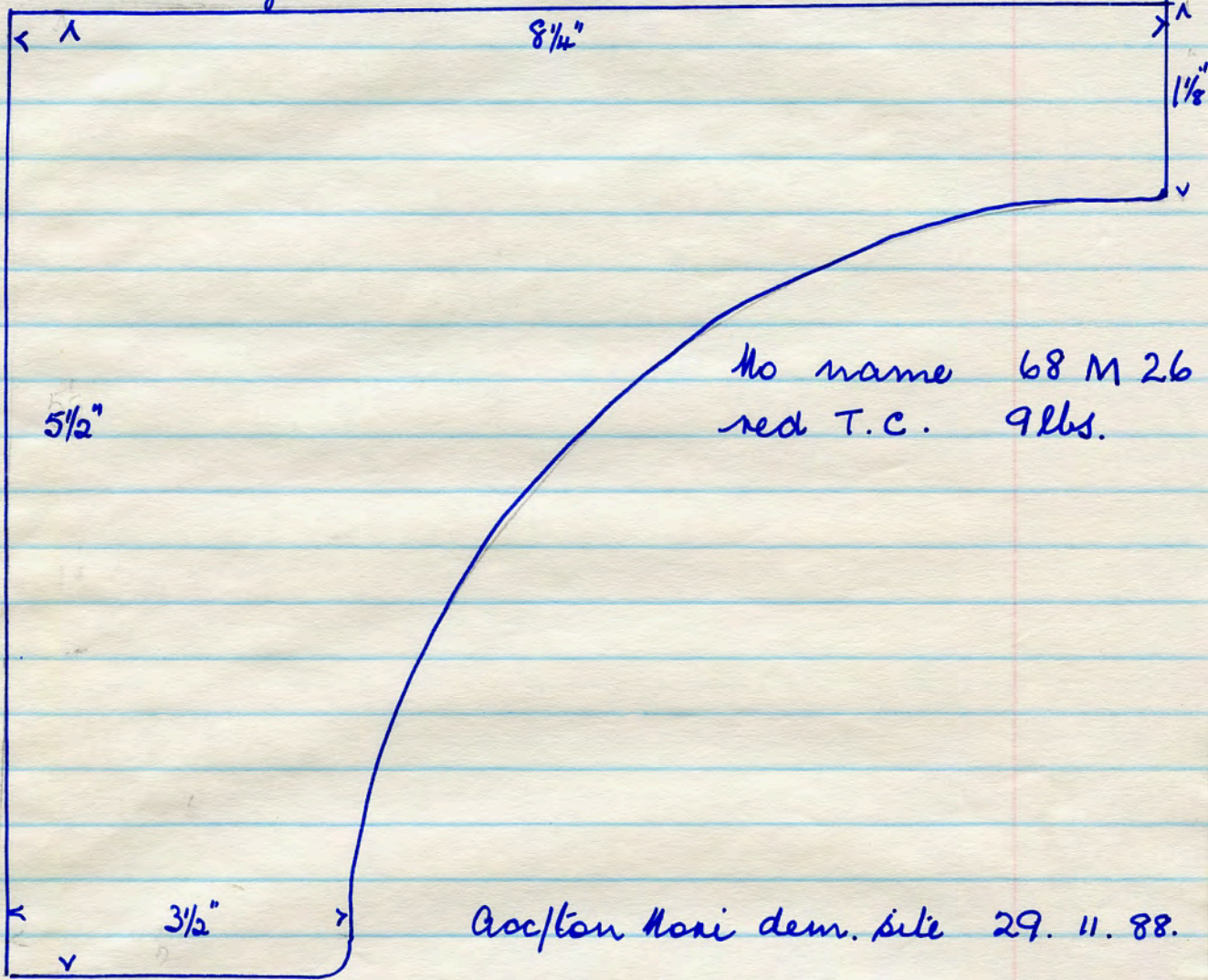

4050

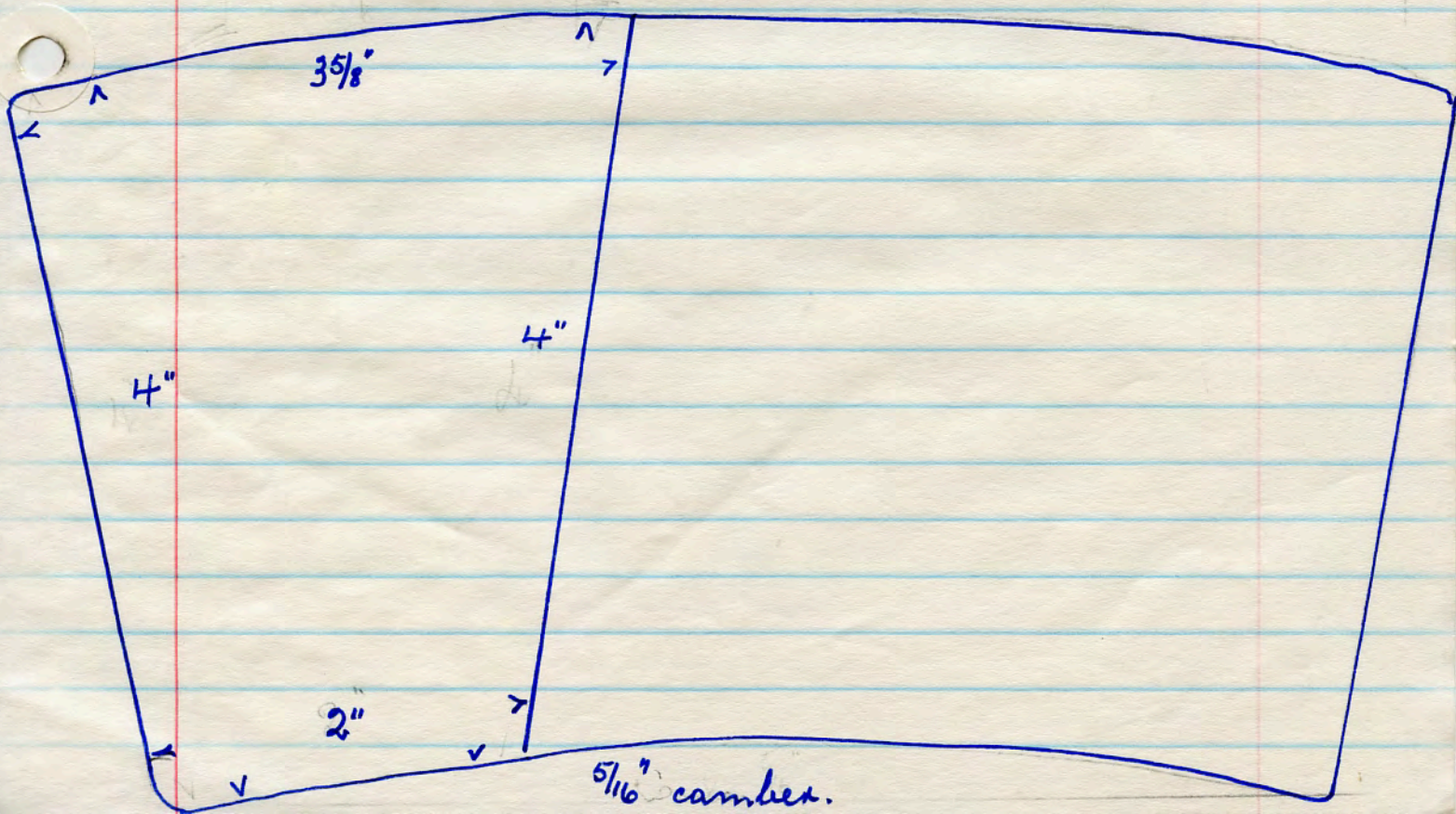

4051

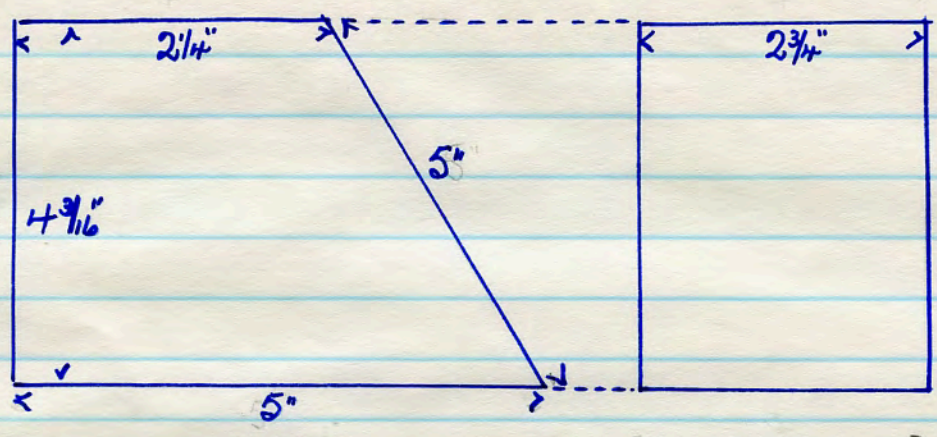

No name
 FC 9
 red T.C.
 5 1/2 lbs

4052

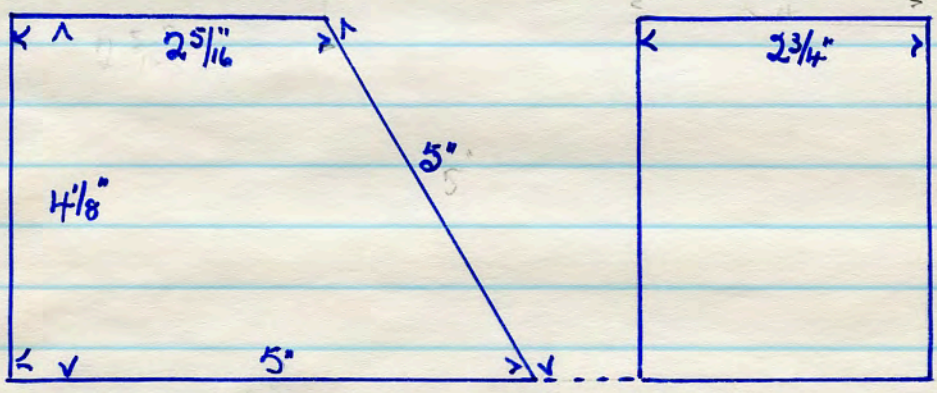

No name
 FC 8
 red T.C.
 5 1/2 lbs

4053

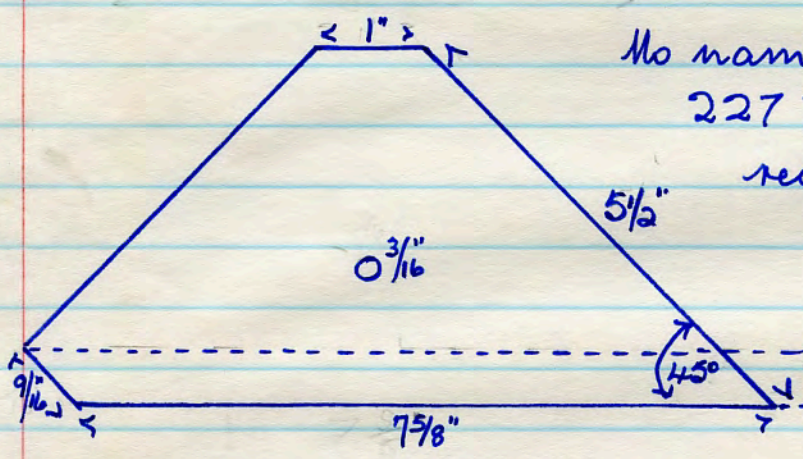

No name
 227 T.
 red T.C.
 6 lbs.

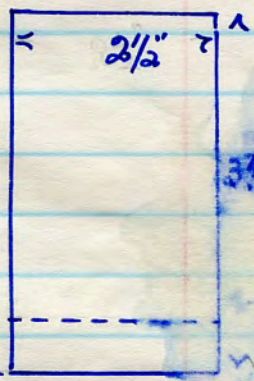

4054

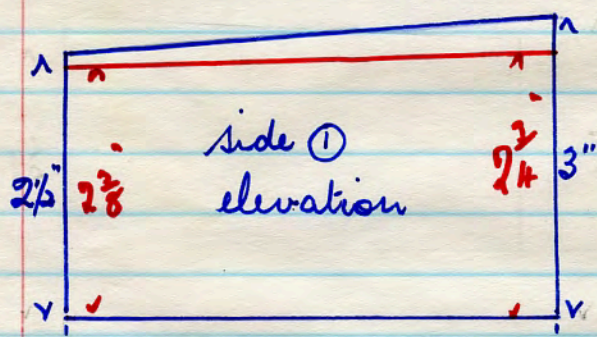

No name. 38 H 729.
 red T.C. 3 lbs.

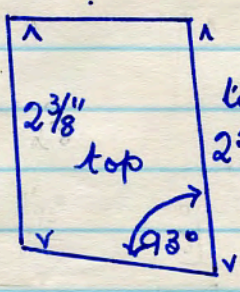
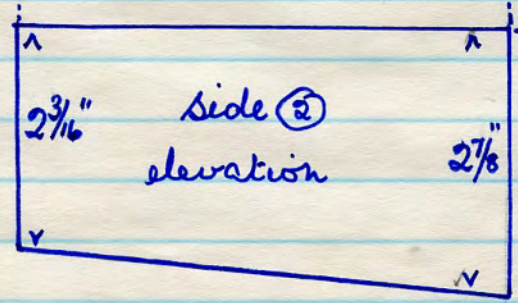

All from Acpton Moni dem. site 29. 11. 88.

No name 75 200

red T.C. 4 1/2 lbs
7"

4055

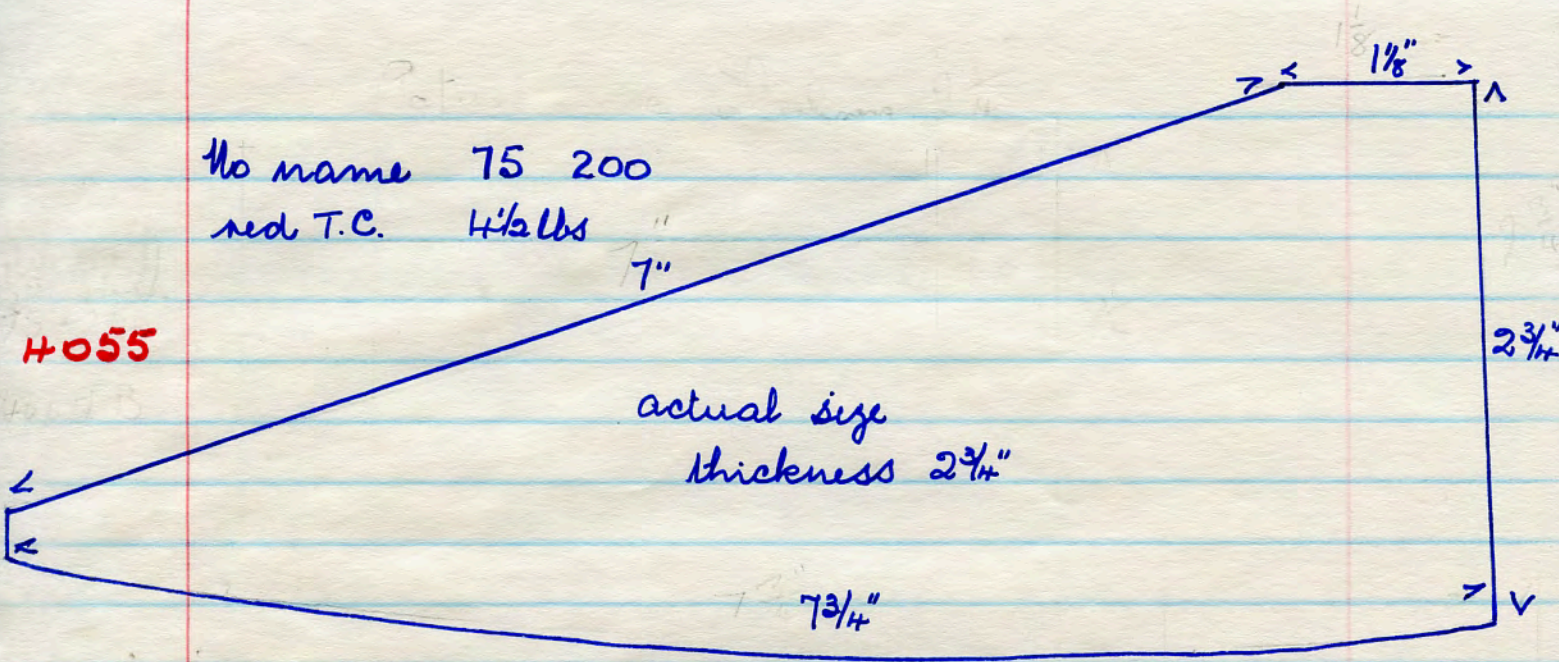

actual size
thickness 2 3/4"

No name. 16 MD red T.C. 8 1/2 lbs.

4056

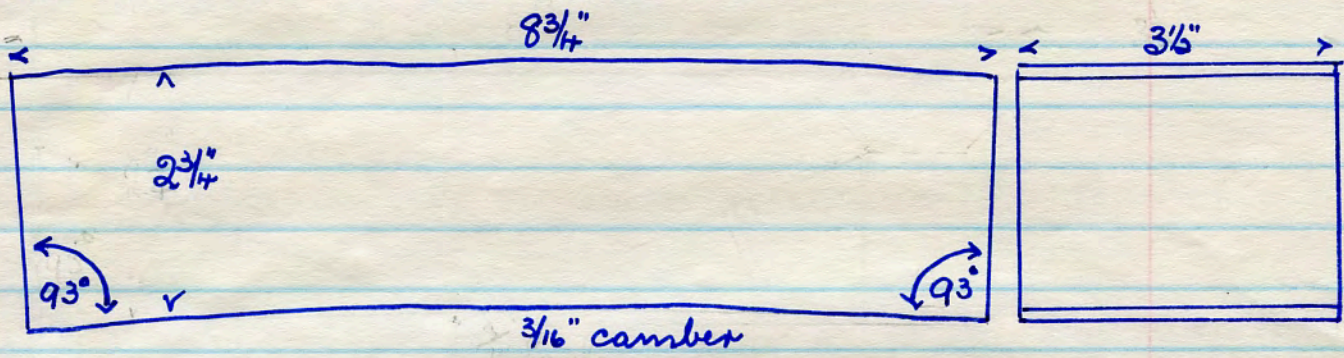

No name. 63N 607 red T.C. 3 lbs.

4057

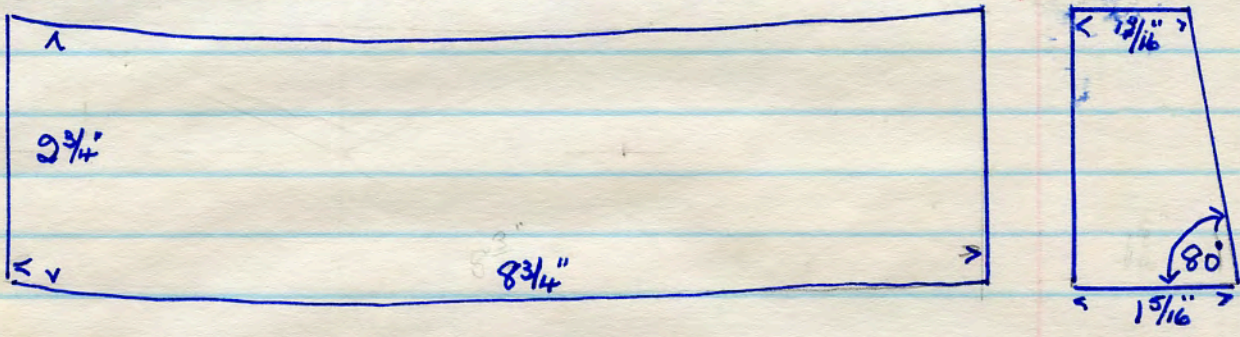

All from Accpton Mori dem. site 28. 11. '88.

No name 57 H 29 red T.C. 10 1/2 lbs

HB moulder's stamp.

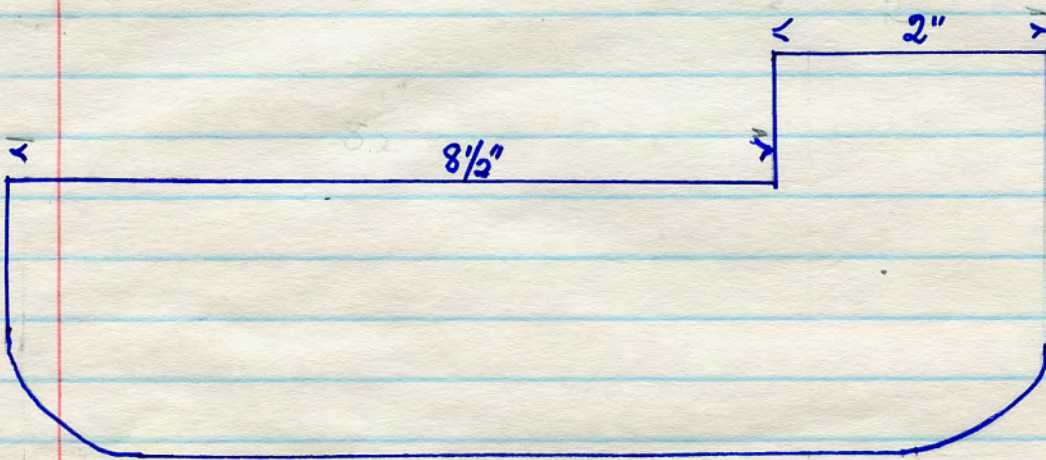

4058

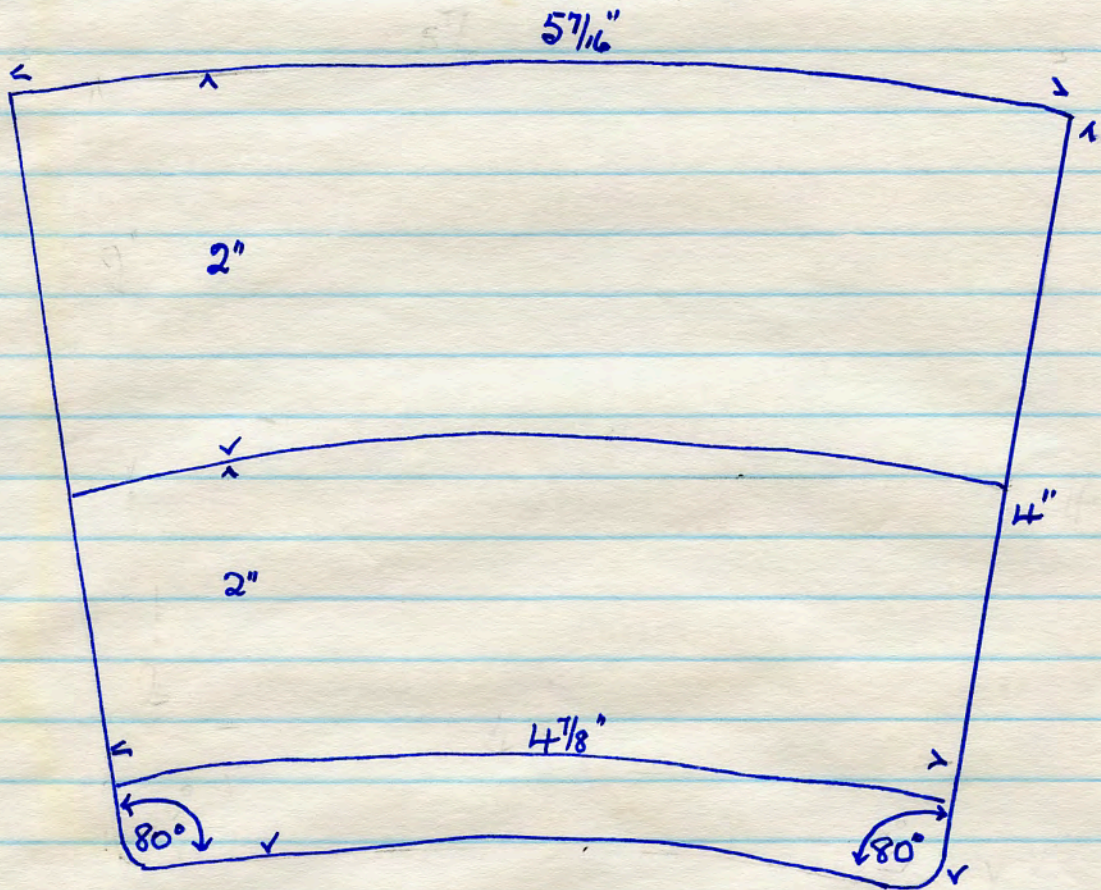

Acc/ton Mori dem. site 30. 11. '88.

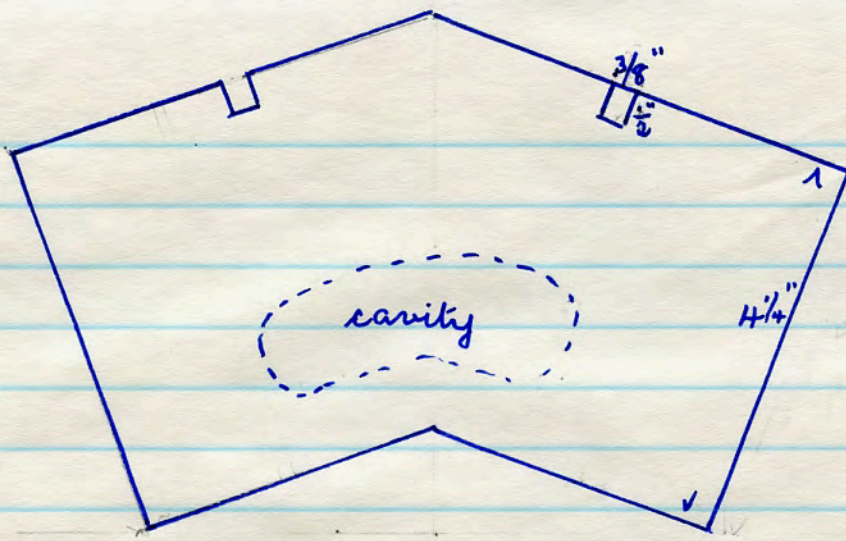

No name
 297 TB
 red T.C.
 25 1/2 lbs

4059

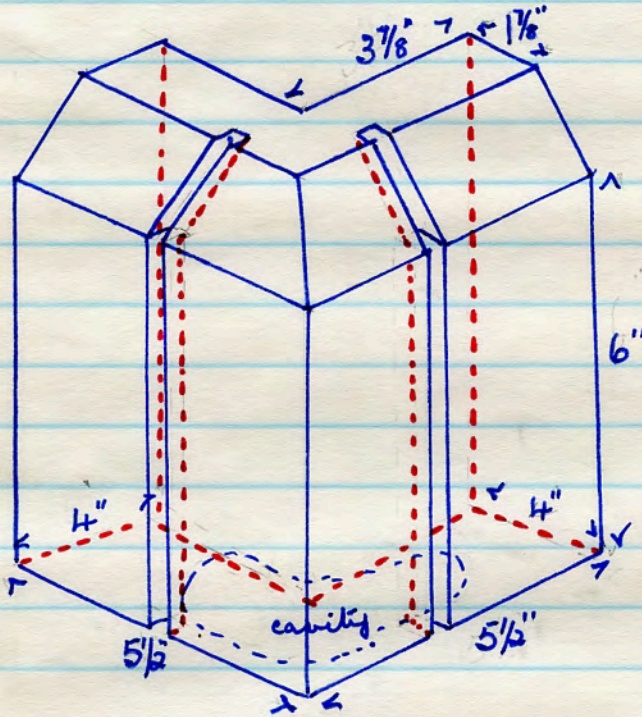

Acc/ton Mon dem site
 21. 11. 88.

No name. PZ red T.C. 9 lbs

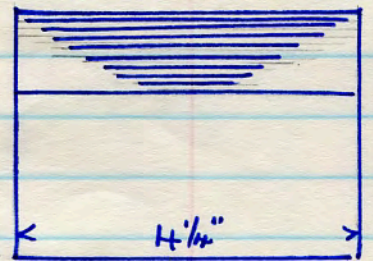
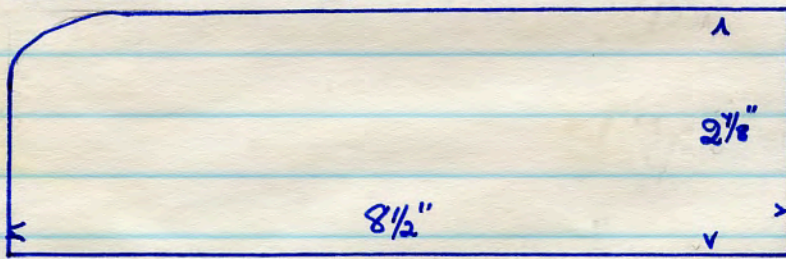

4060

No name 33 MC red T.C. 3 lbs.

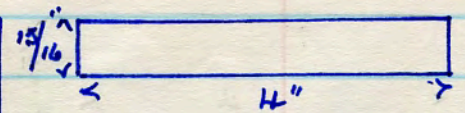
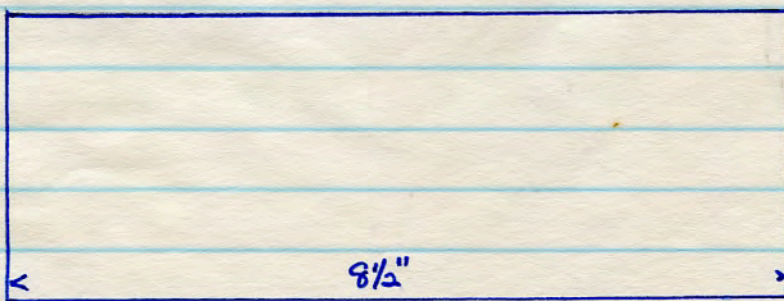

4061

Acc/ton Moni
 dem. site
 1. 12. 88.

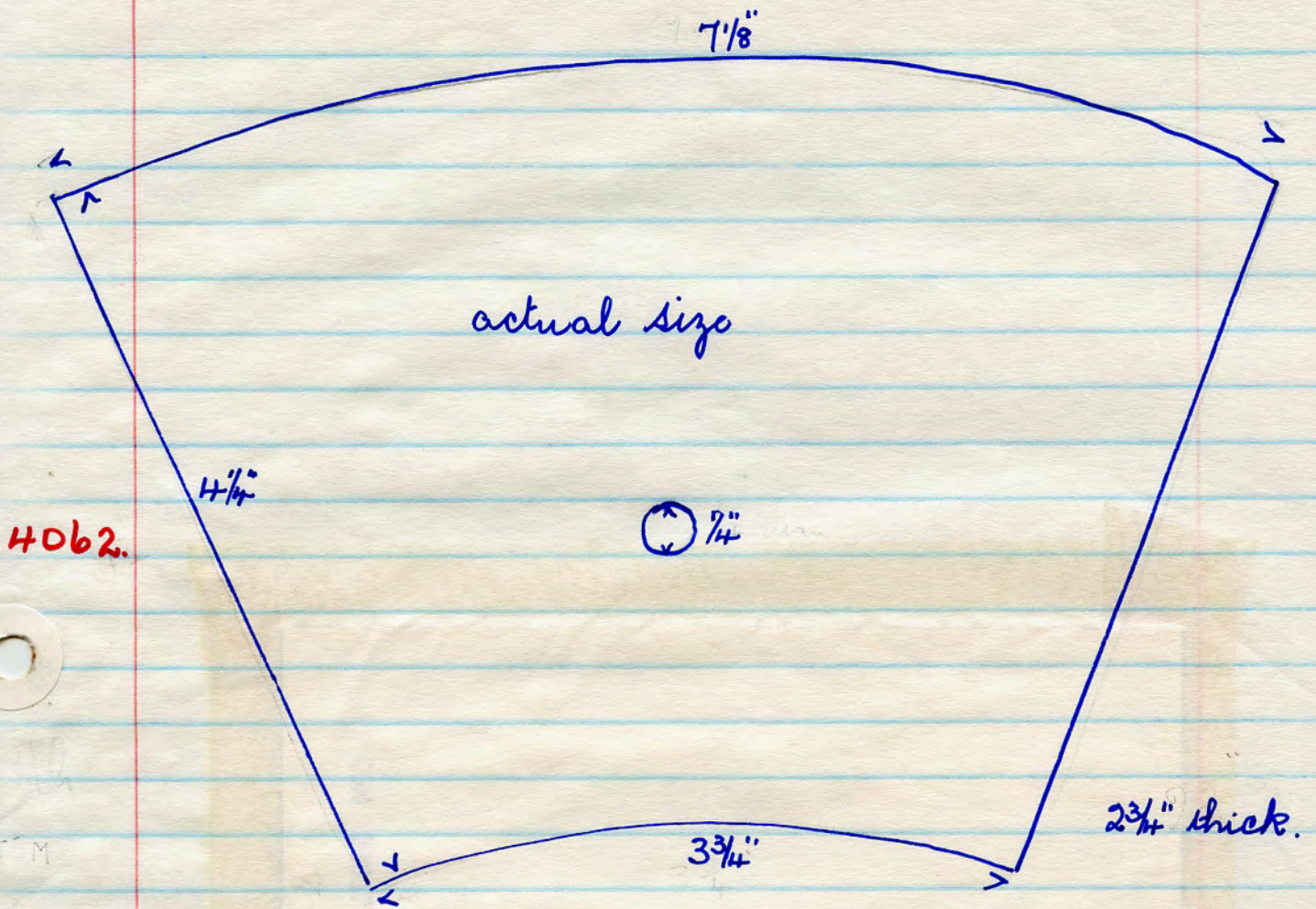

No name 55 M 53 red T.C. 6 lbs.
 Acpton Hosi dem. site 2. 12. '88

1/18

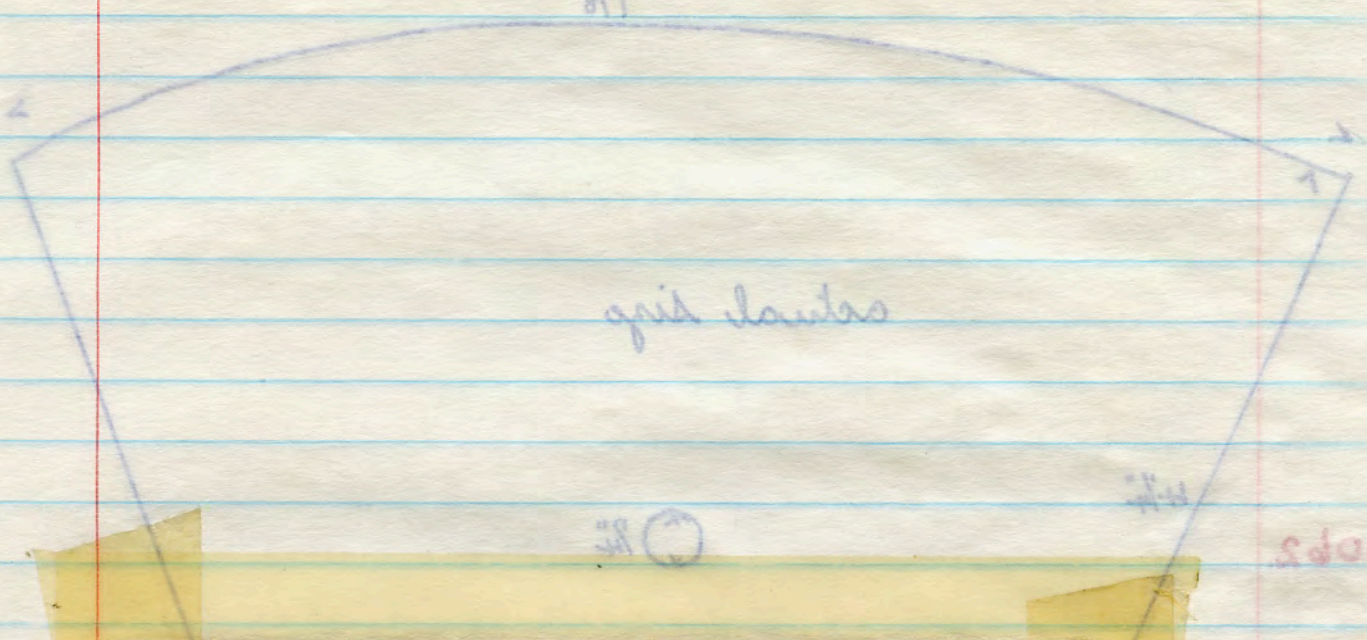

grid lautas

1/18

1/18

Hops



all
load

4063

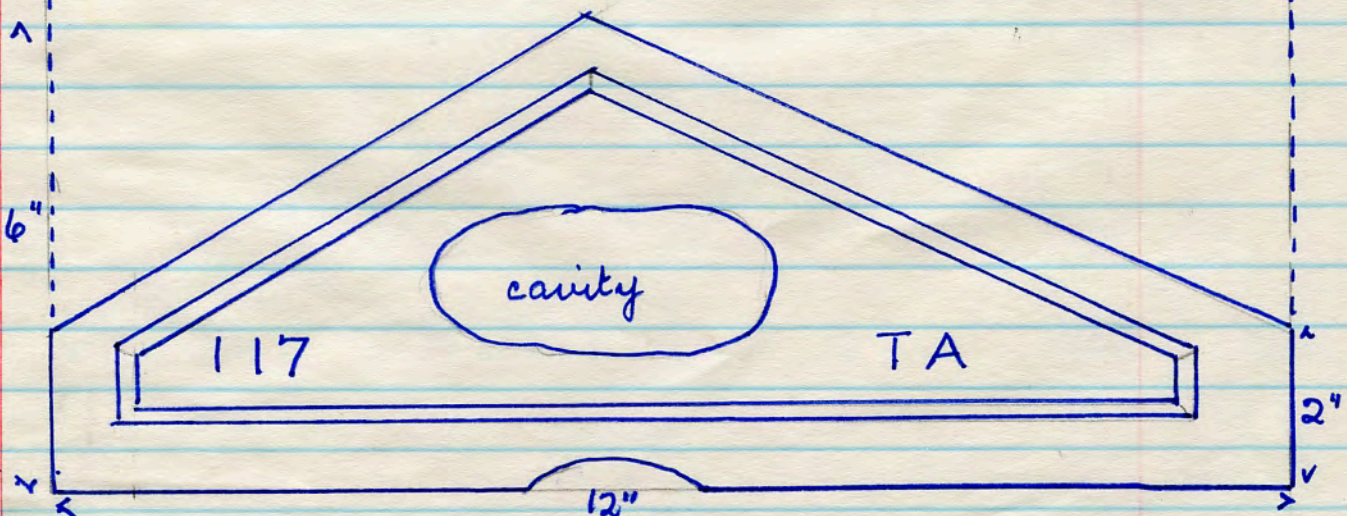
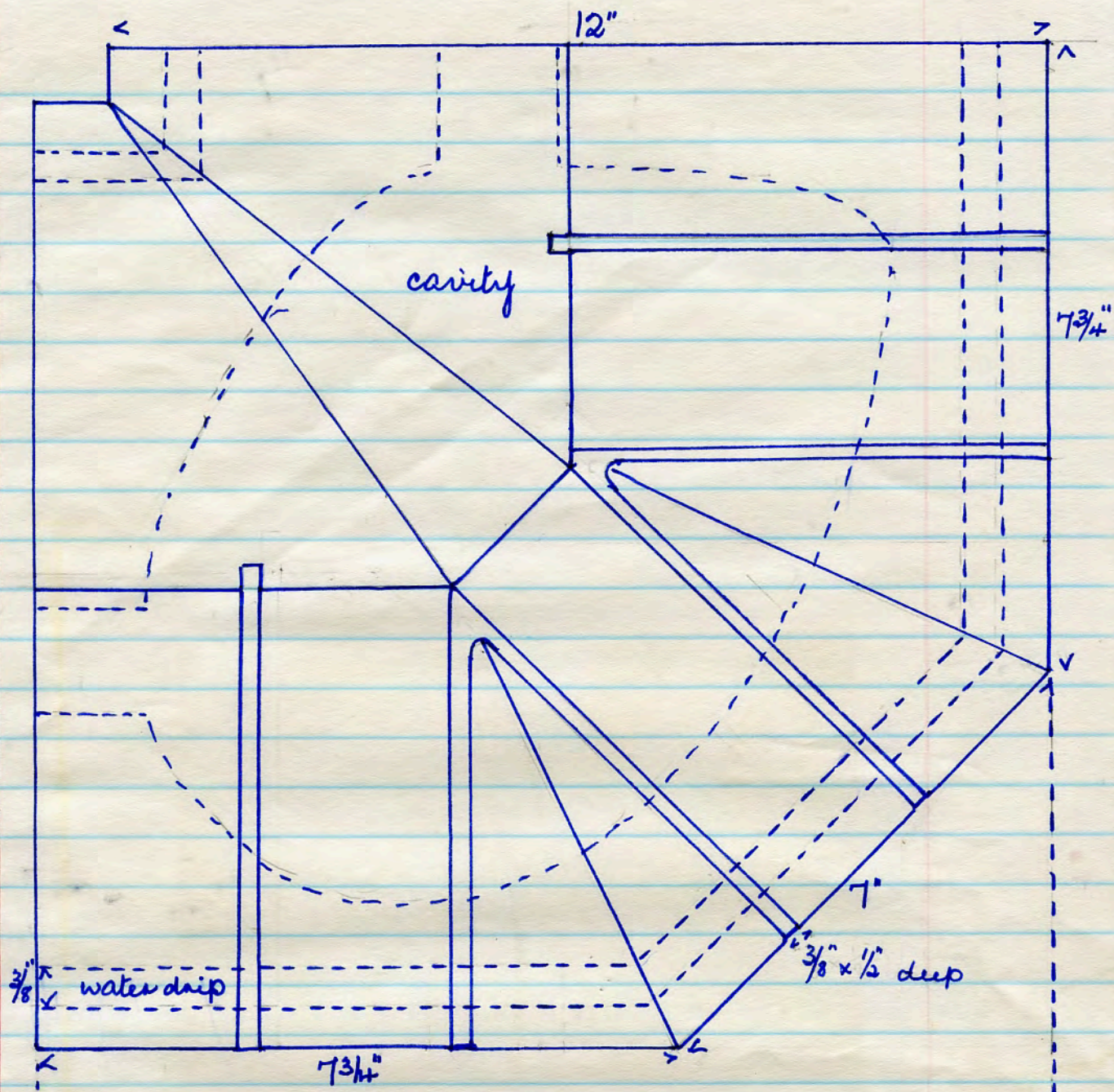

No name 117 TA red T.C. wall return. 32 lbs.

4064

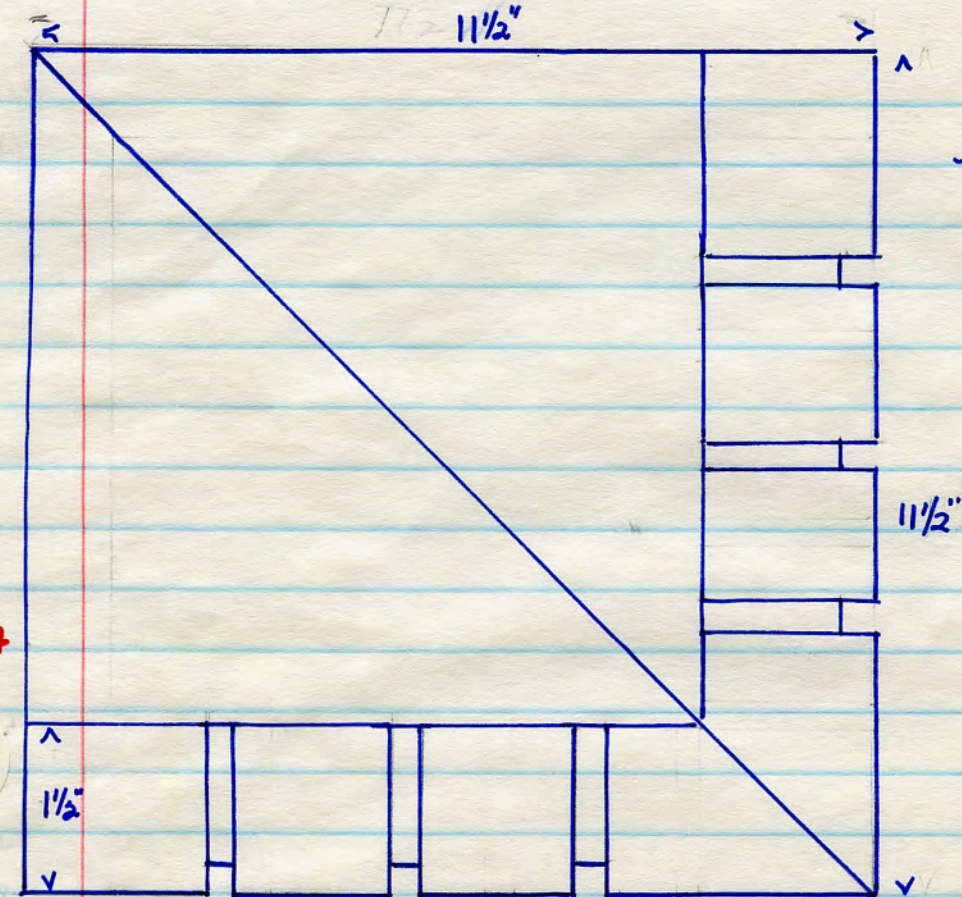

No name
 129 TA
 red T.C.
 28 lbs.

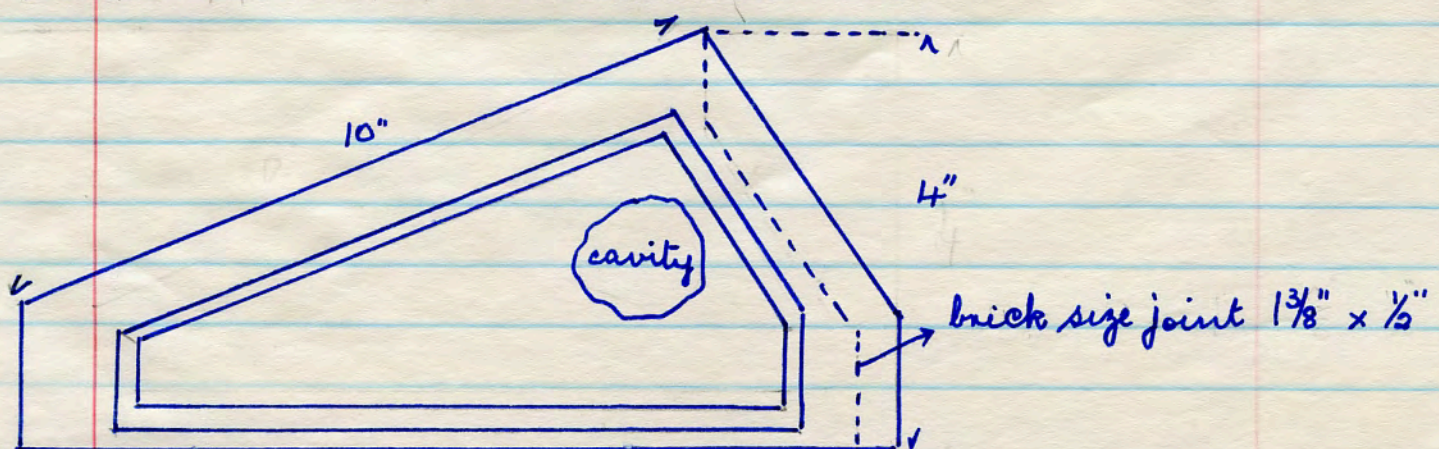
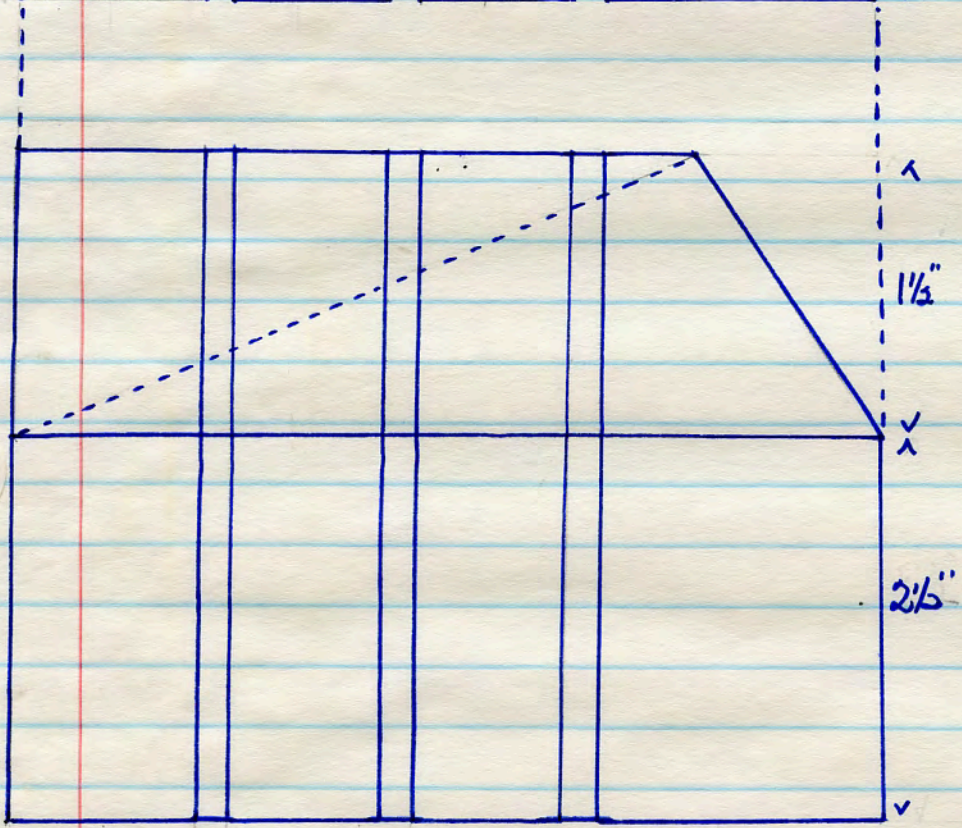

brick size joint $1\frac{3}{8}'' \times \frac{1}{2}''$

4065

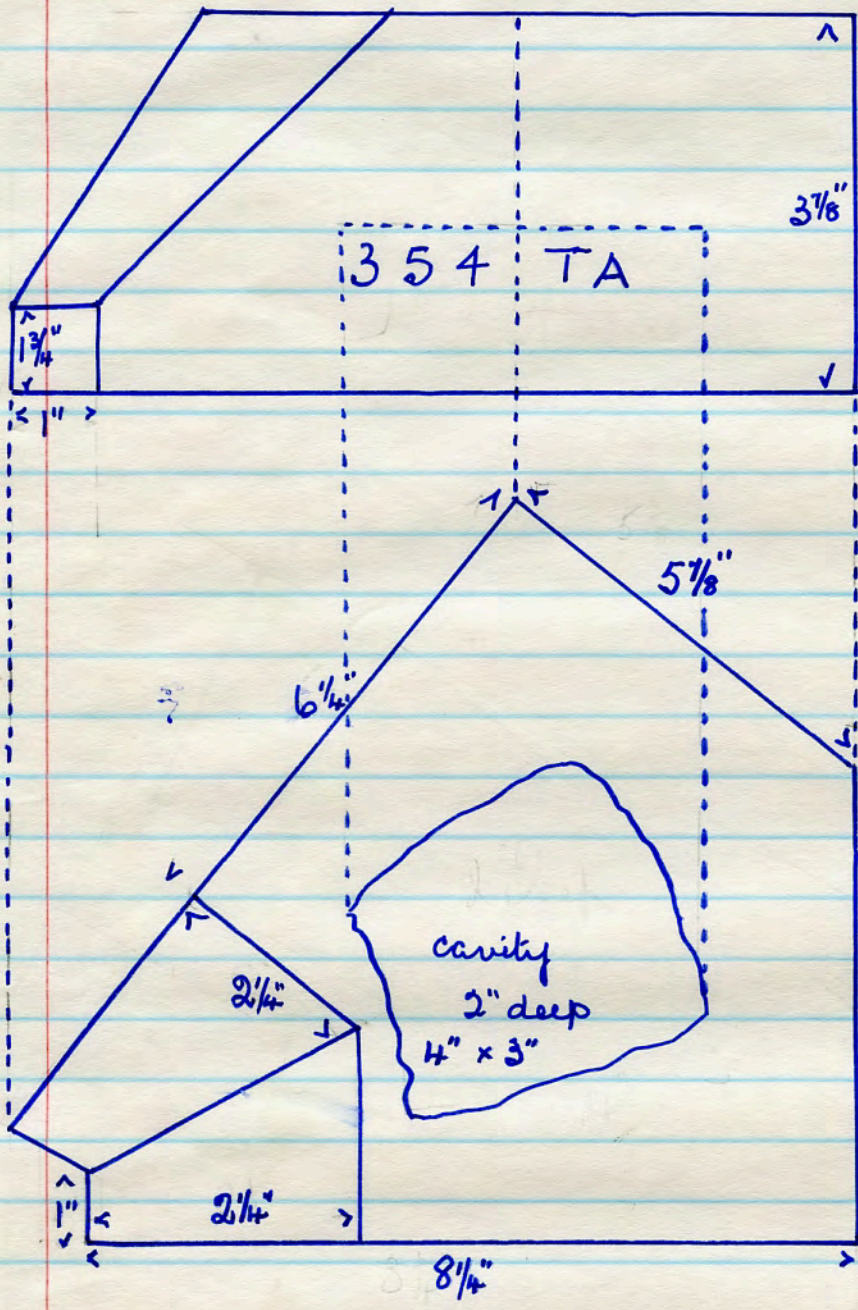

No name
 354 TA
 red T.C
 16 lbs.

4066

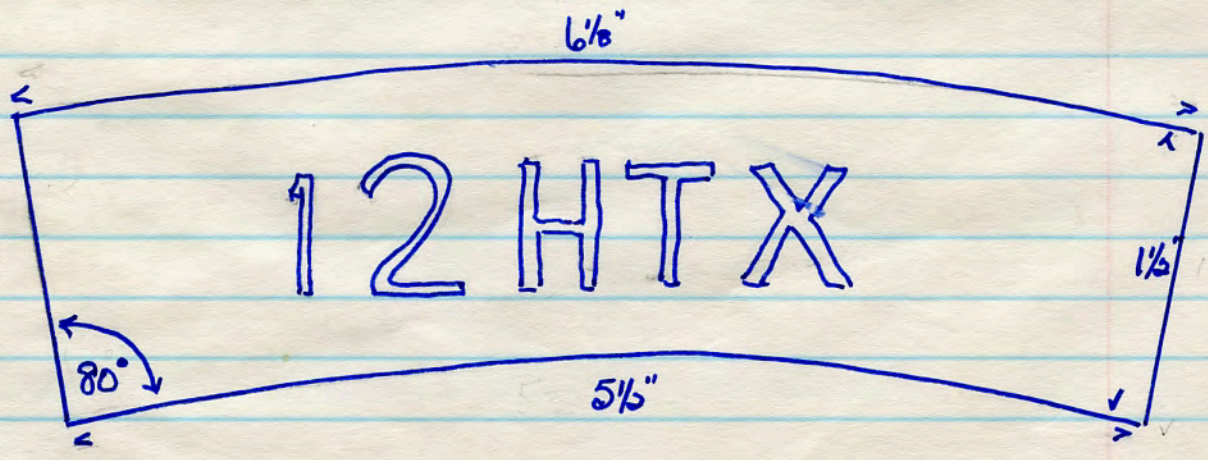

No name 12 HTX red T.C. 2 1/2 lbs 2 7/8" wide
 Acopton Mori dem. site 3. 12. '88

4067

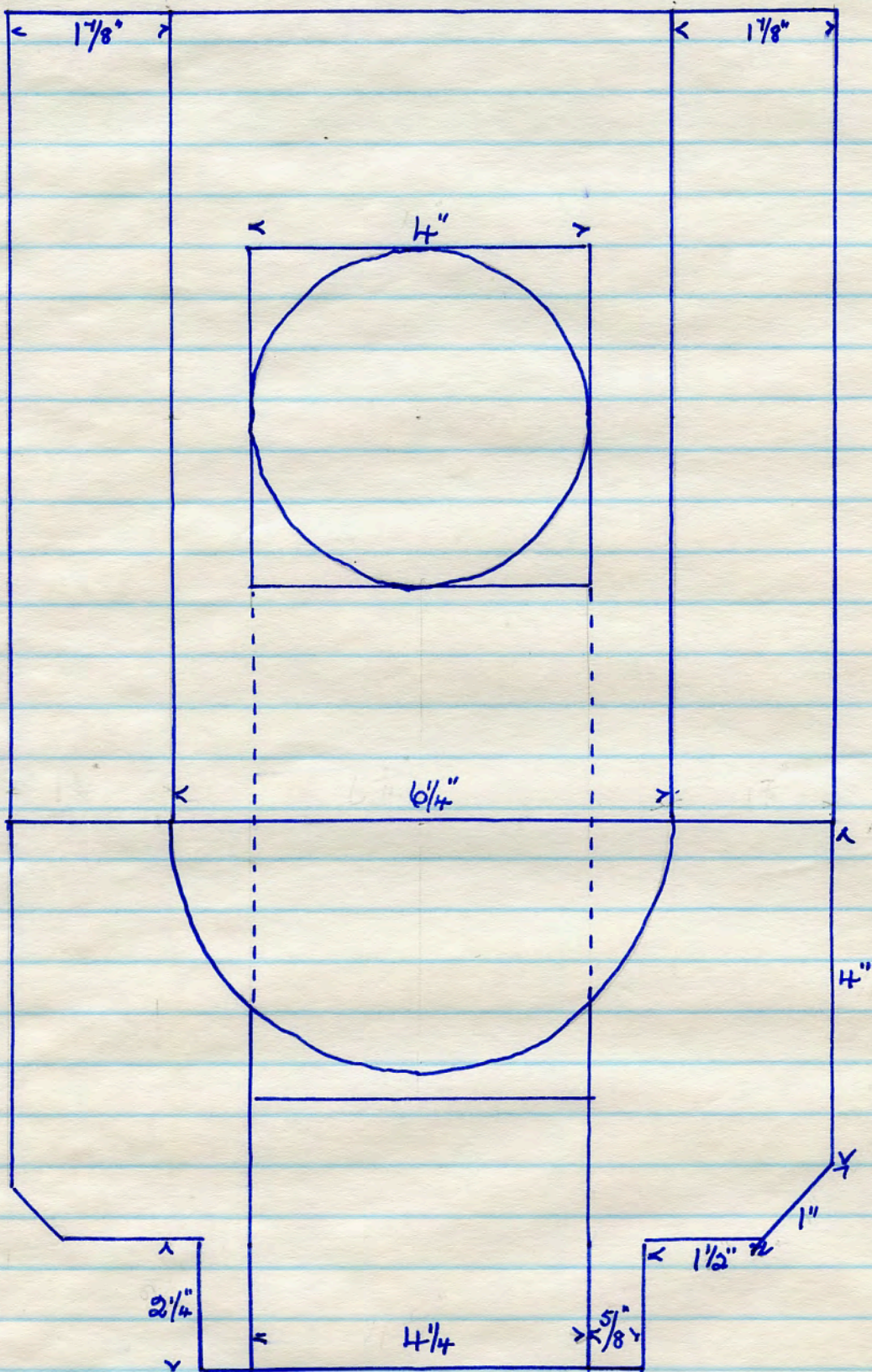

No name. 6 RS red T.C. 28 lbs.
Acc/ton Mari dem. site 10. 11. '88

4068

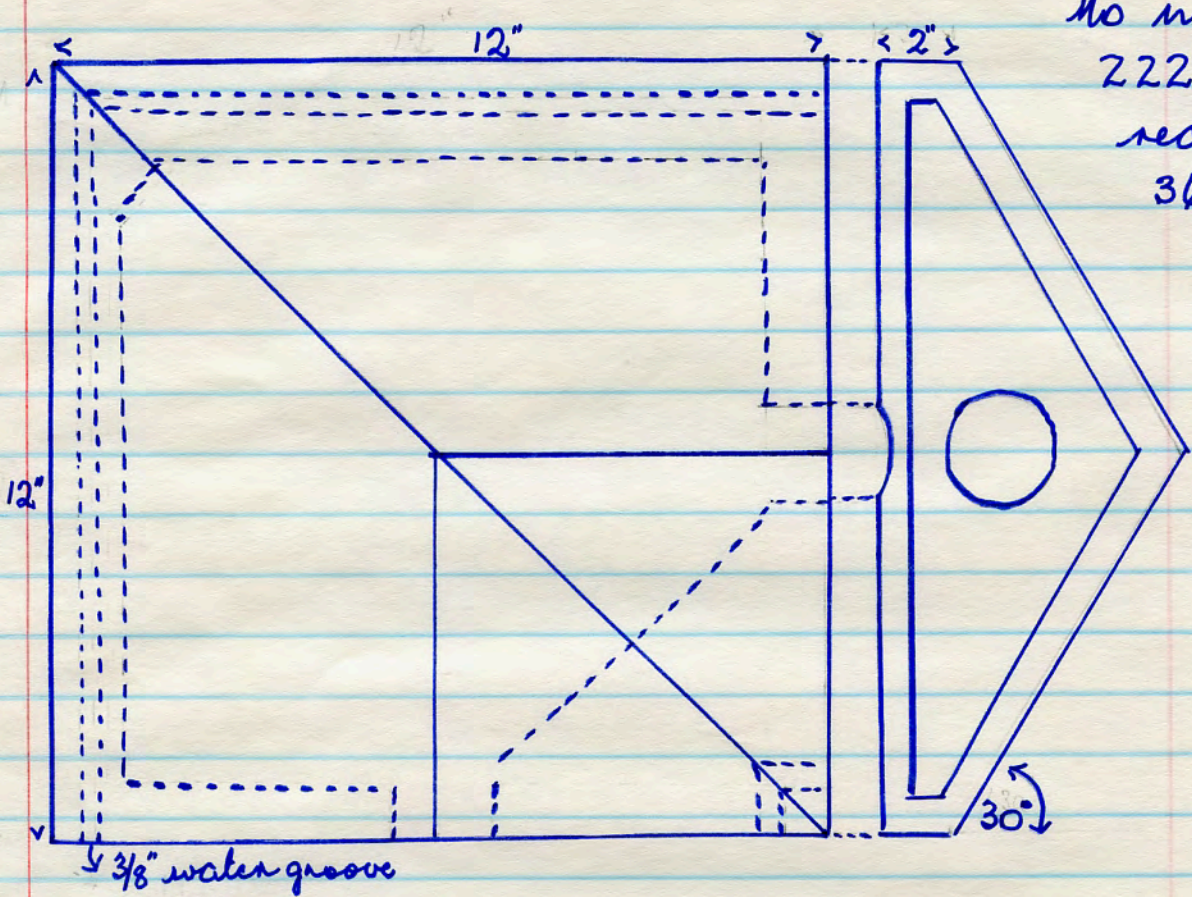

No name
 222 9Q
 red T.C.
 36 lbs.

4069

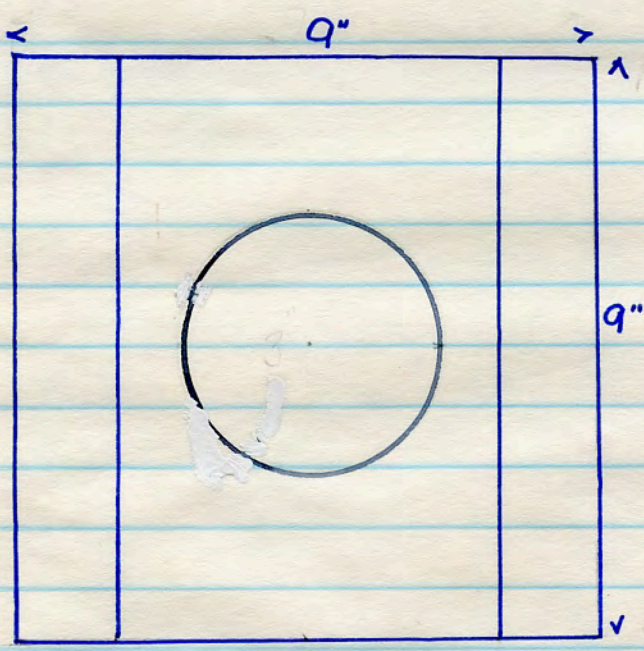

No name PP573
 red T.C. 16 lbs.

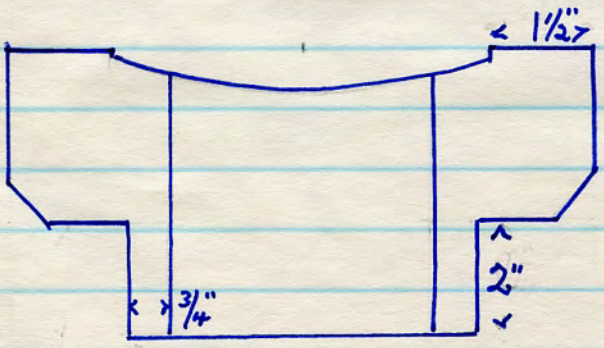

No name 676 red T.C. 29 lbs J1 moulder's stamp.

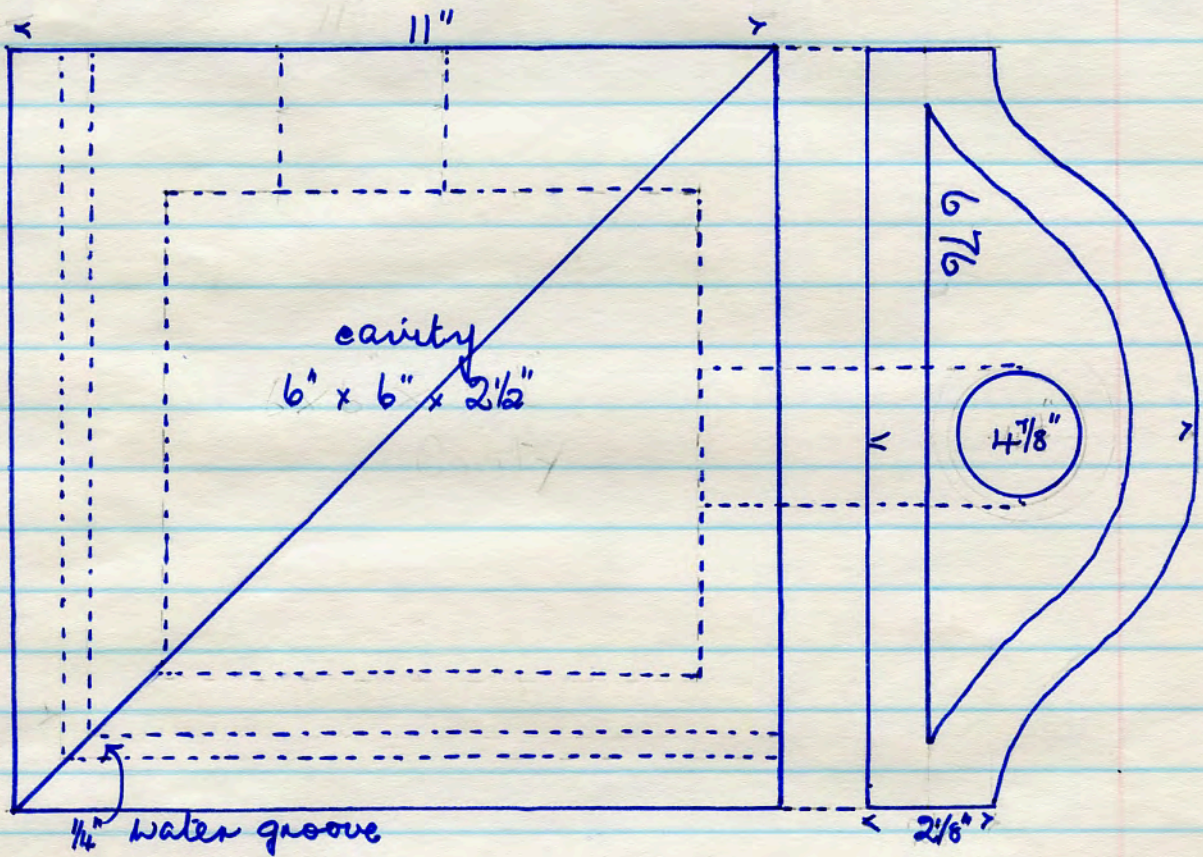

4070

Acpton Mori dem. site 20. 11. '88

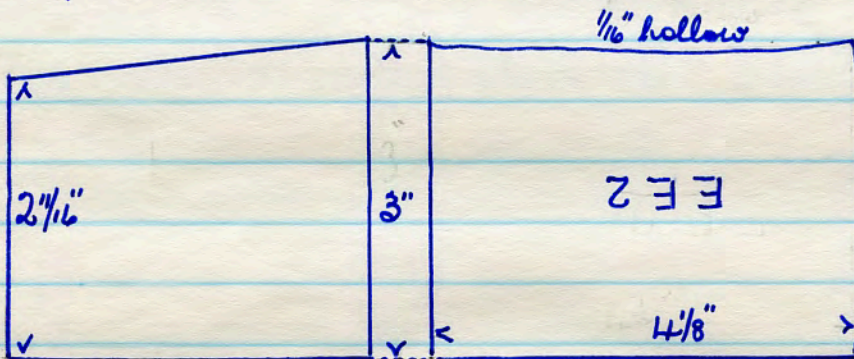

No name EE2
red T.C. 4 lbs

4071

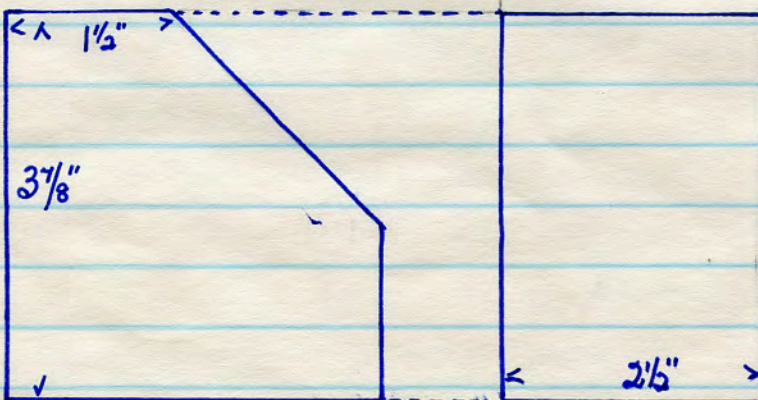

No name. RM BG
dark brown T.C.
3 lbs.

4072

Acpton Mori dem. site 4. 12. '88

4073

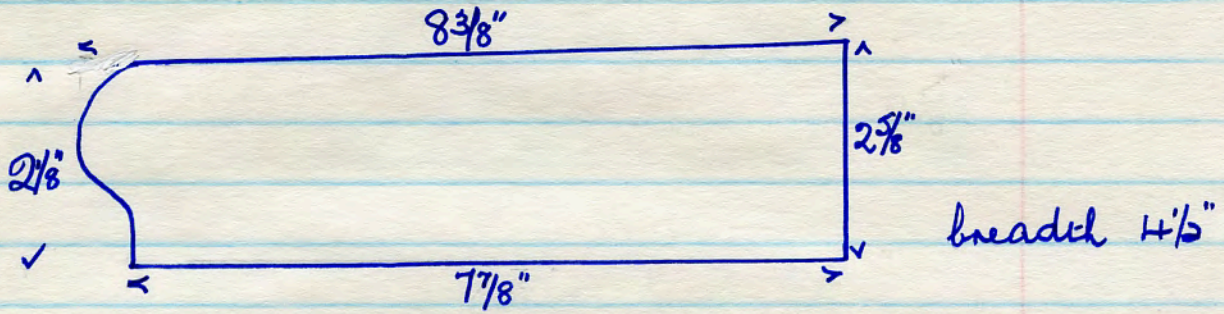

No name 222 TBX red T.C. 8 lbs.

4074

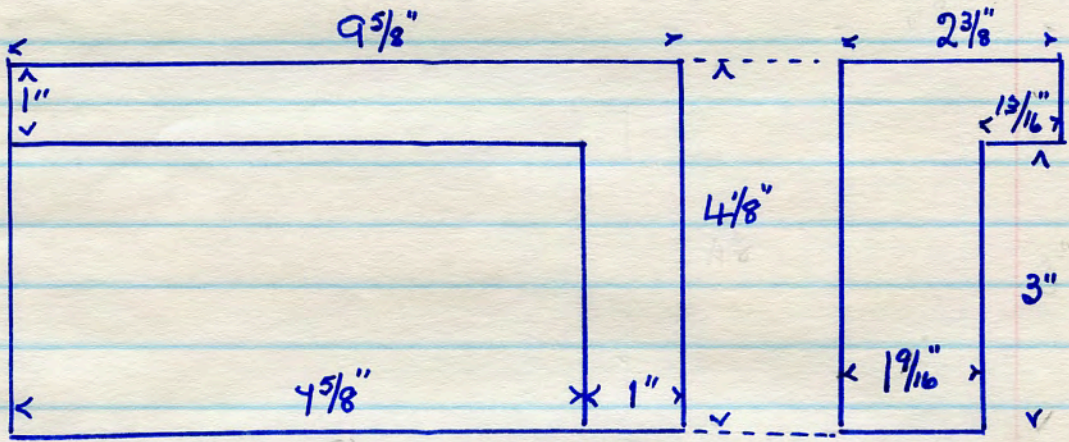

No name 982 VYL red T.C. 6 lbs.

4075

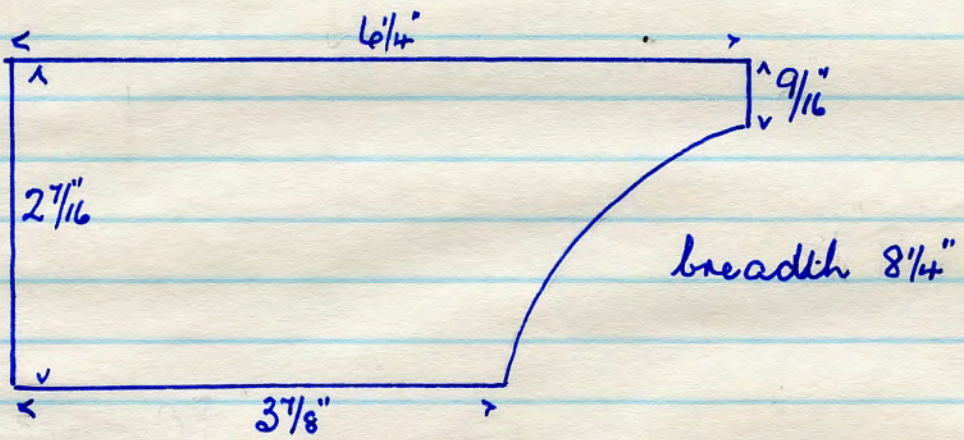

No name 129 T.C red T.C 9 lbs.

Acfton Mari dem. Site 4. 12. '88

4076

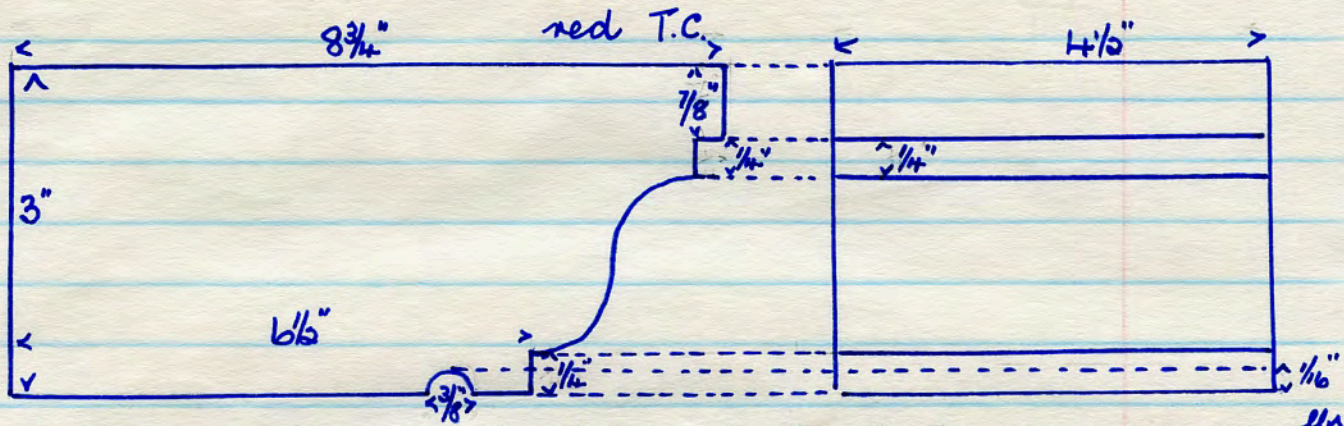

No name. No 89 in Tomfield Bk + J. L. Co. Ltd. catalogue. 10 1/2 lbs.

4077

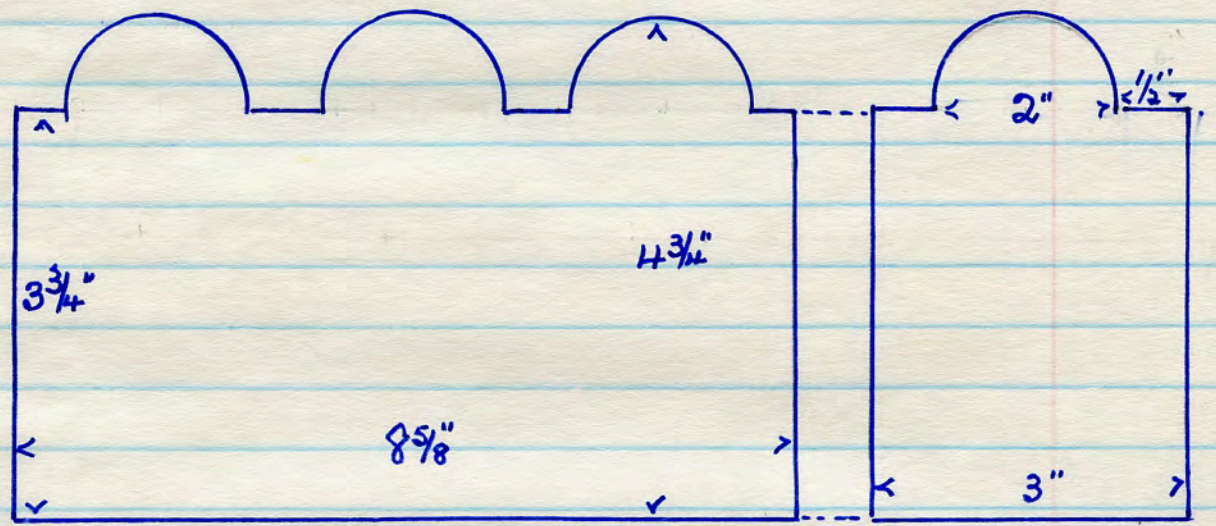

No name. No 95 in Tomfield Bk + J. L. Co. Ltd. catalogue. 10 1/2 lbs. red T.C.

4078

No name. 329 U2 red T.C. 12 1/2 lbs

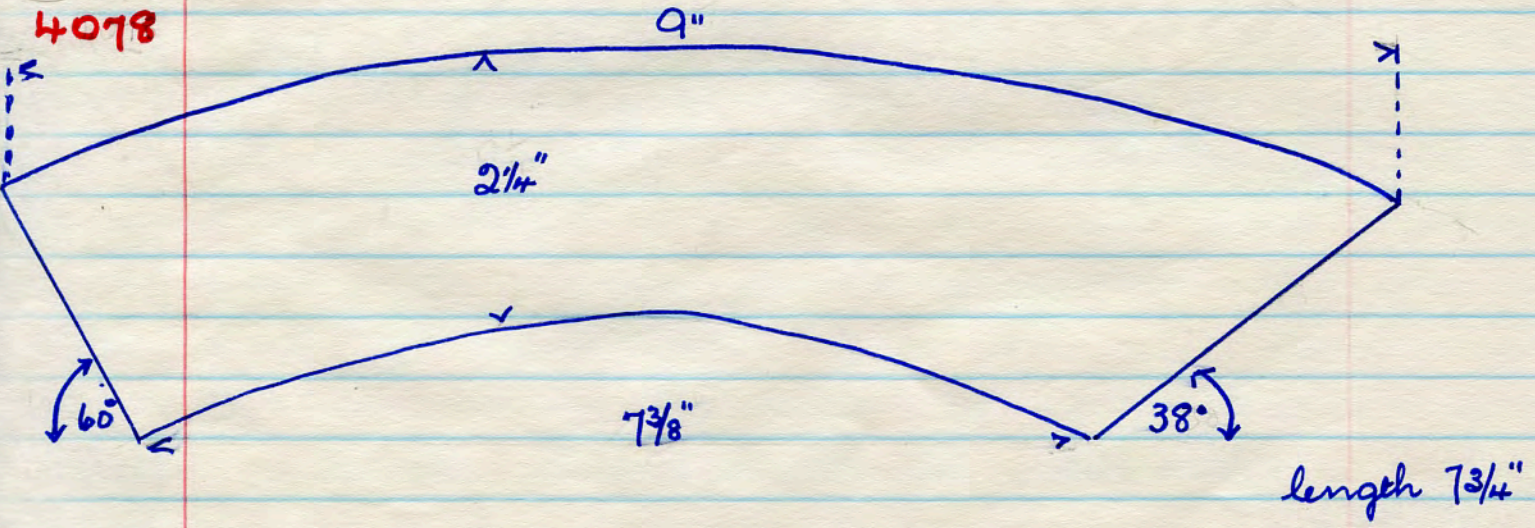

Rec/ton Hosi dem. site 5. 12. '88

4079

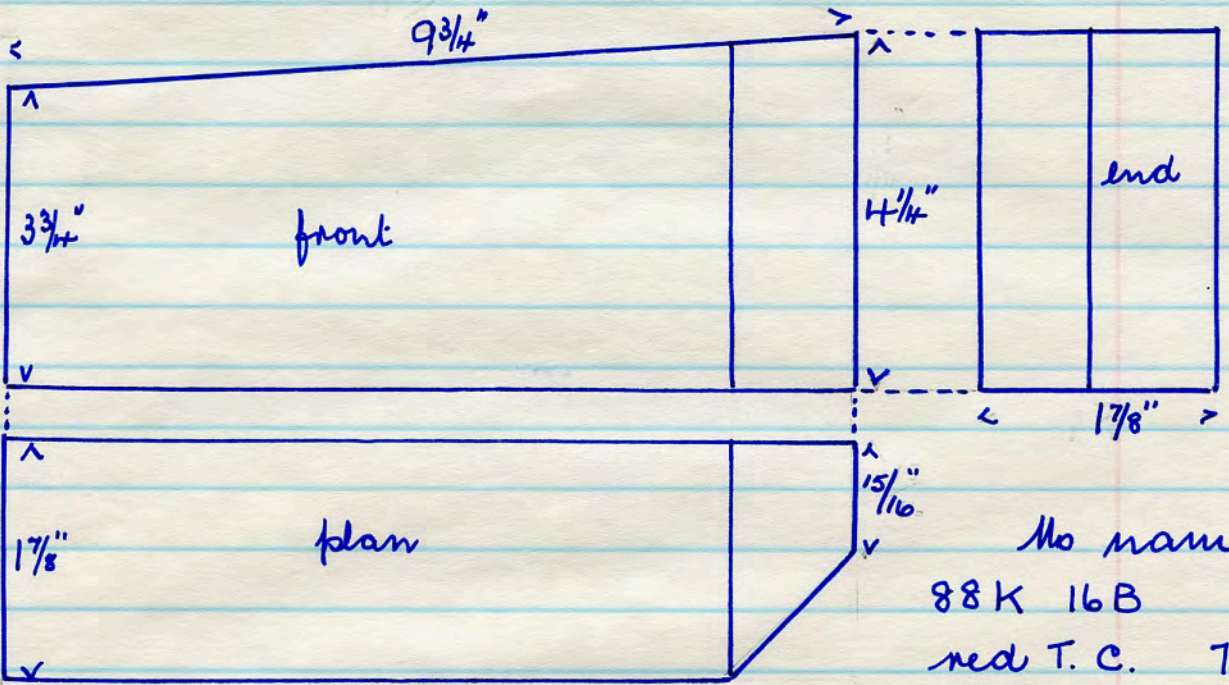

No name
 88 K 16 B
 red T.C. 7 lbs.

specifications as to 4079. but no chamfer on end.

4080

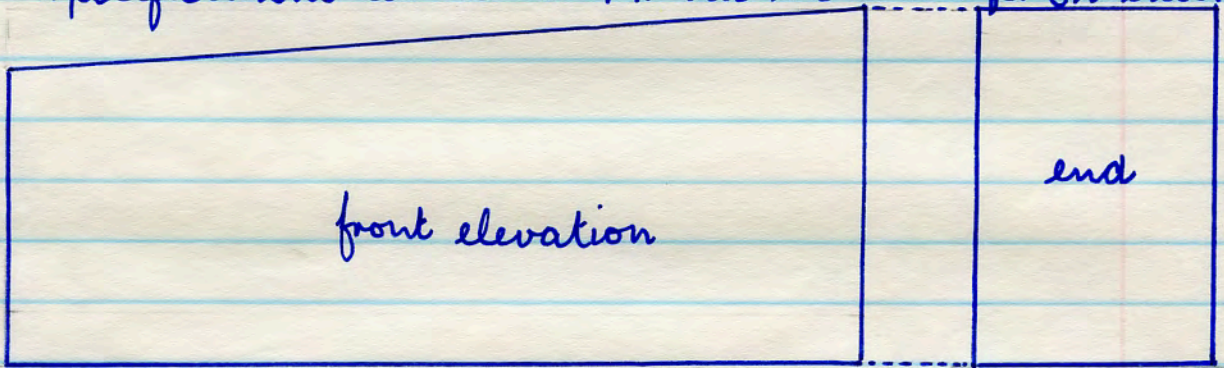

No name
 88 K 15 B.
 red T.C. 7 lbs.

No name 79 L11 red T.C. 8 1/2 lbs HB moulder's mark.

4081

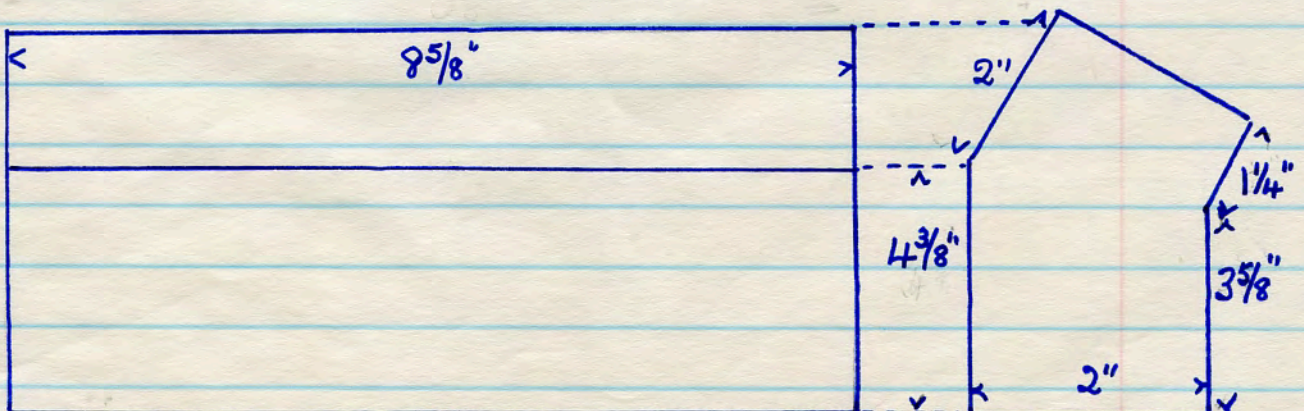

Acpton Mori dem. site 5. 12. '88

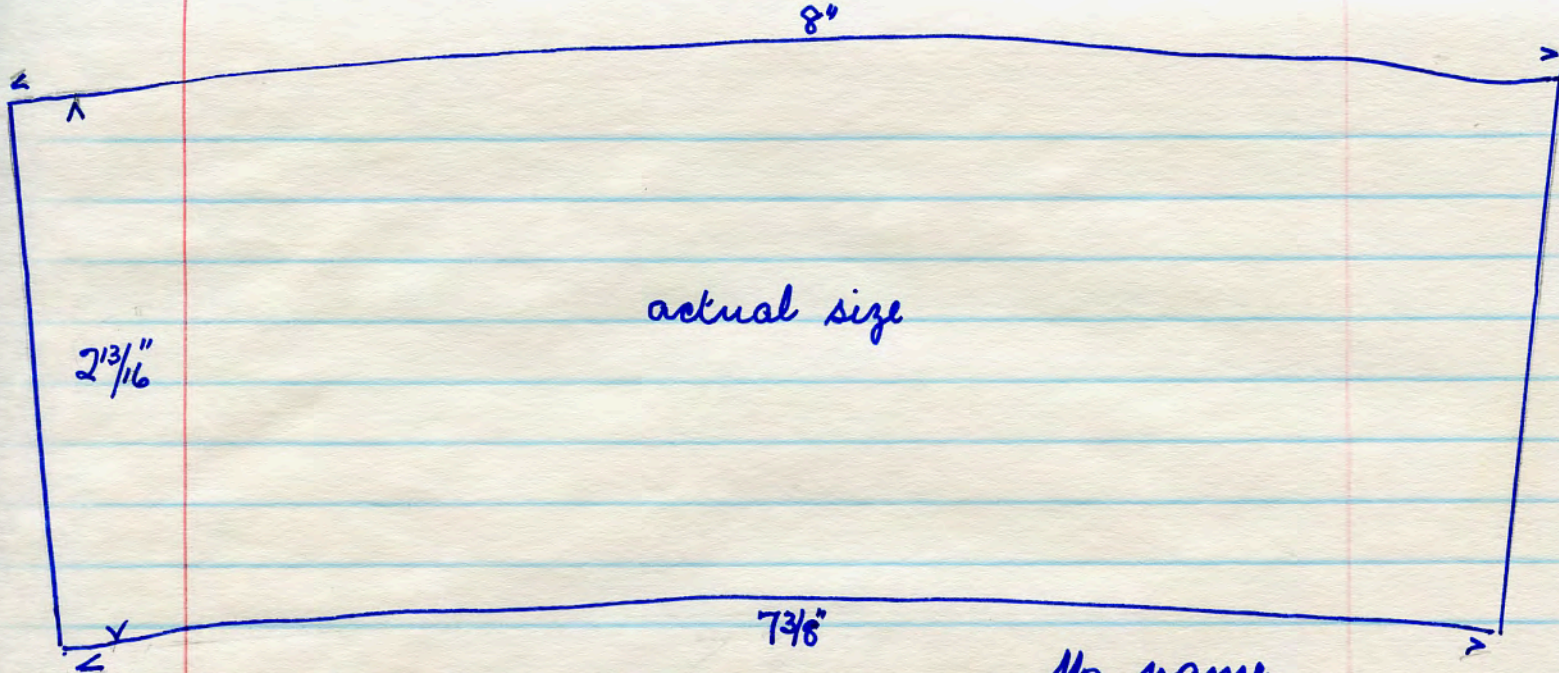

4082

the section is 2⁵/₁₆" square

No name
35 J4
red T. C. 6¹/₂ lbs.

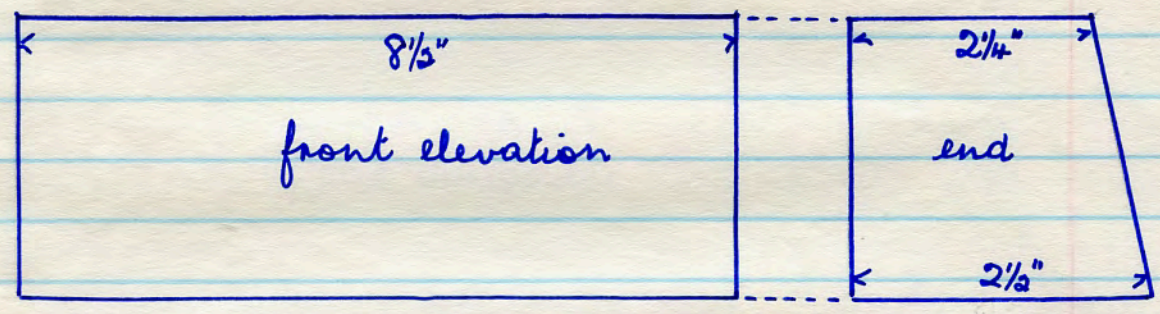

4083

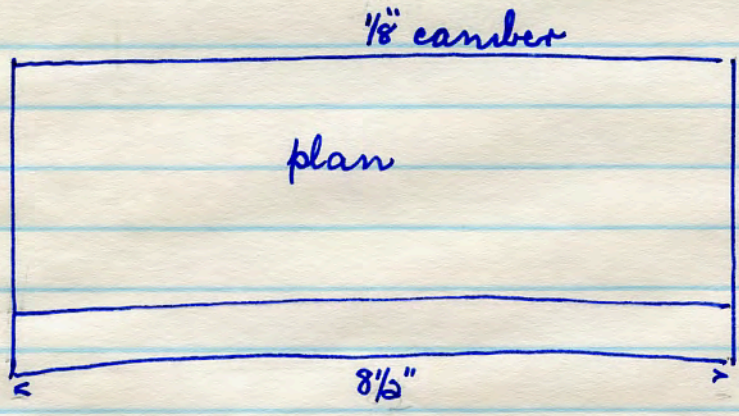

No name
78 K 13
red T. C. 5¹/₂ lbs.

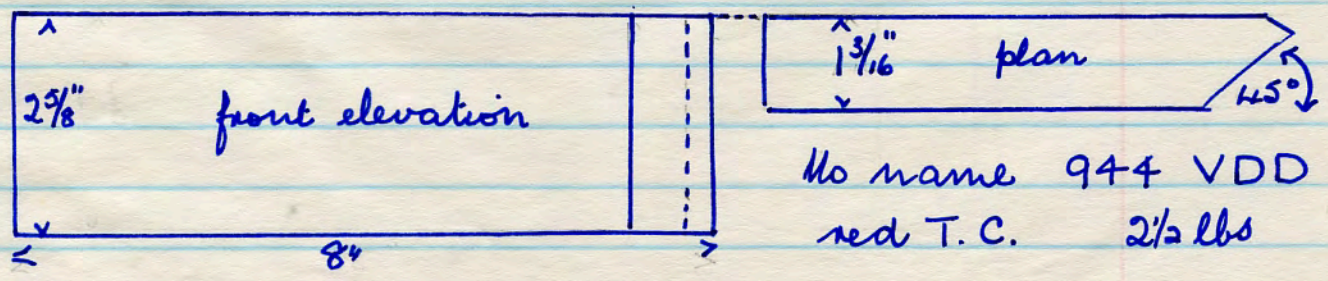

4084

No name 944 VDD
red T. C. 2¹/₂ lbs

Rec/ton Mori dem. site 5. 12. '88

No name. 575 W. red T.C. 28 lbs. J1 moulder's mark.

4085

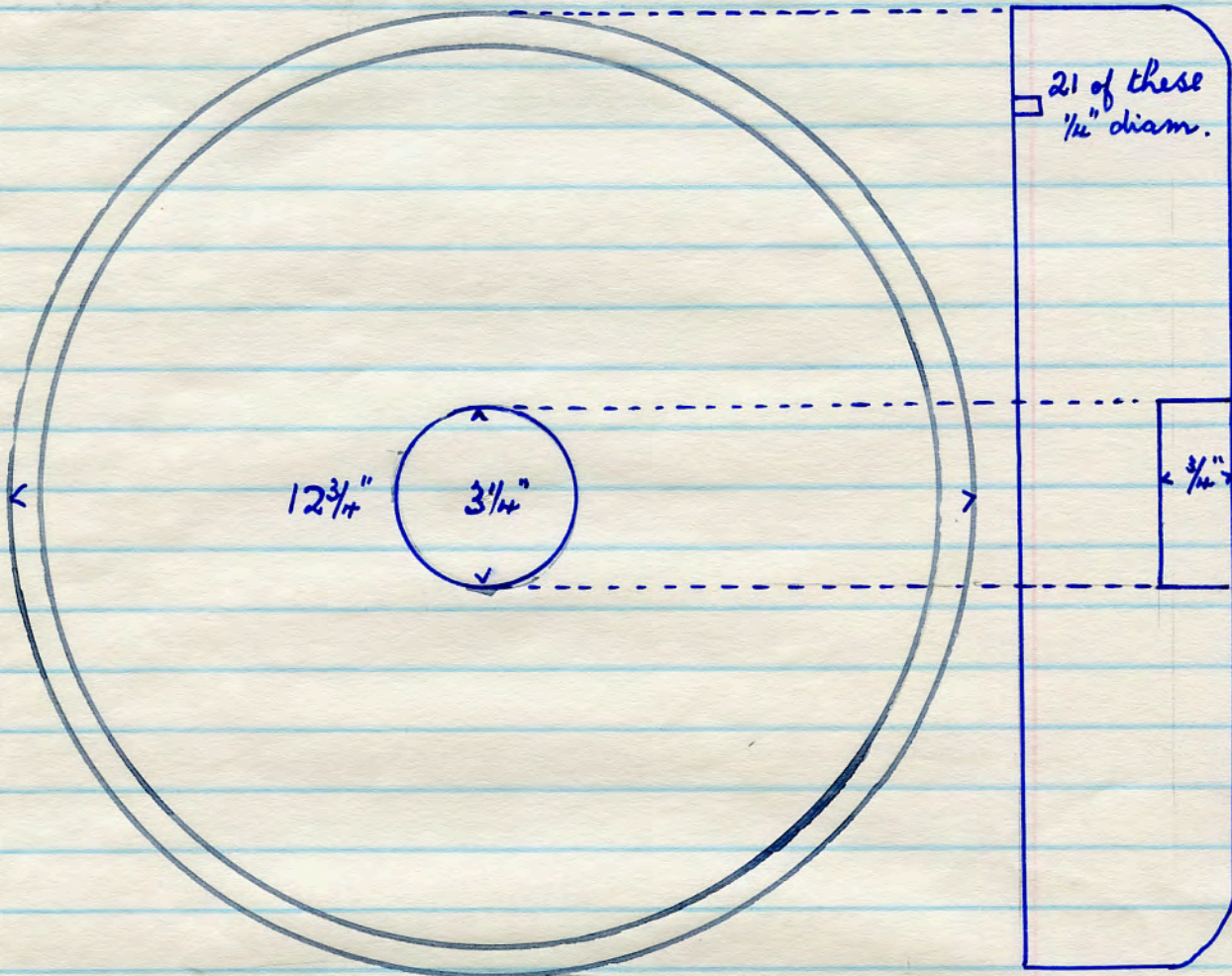

4086

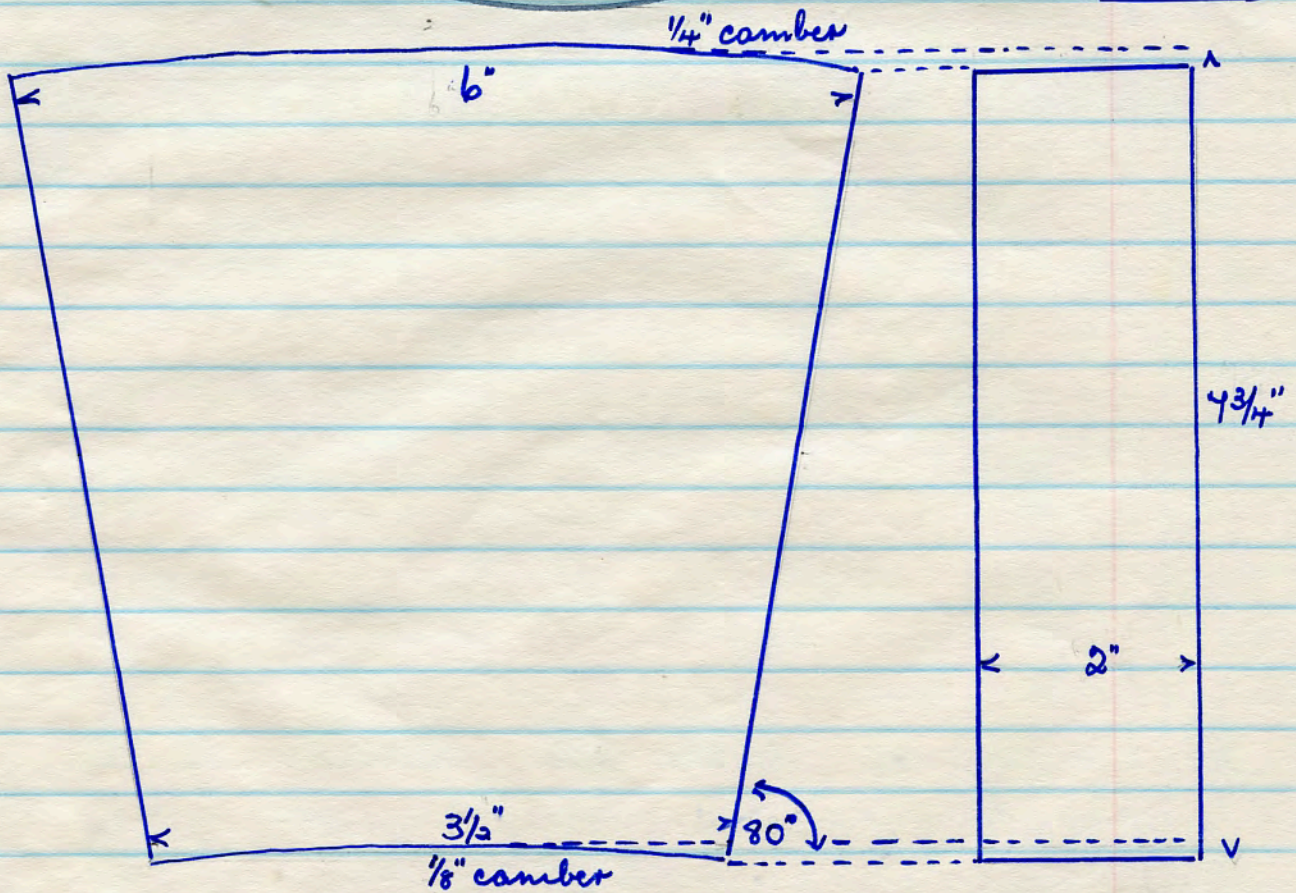

No name. 71 C9 red T.C. 7 lbs. NJ moulder's mark
Acfton Hosi dem. site 6. 12, '98

H087

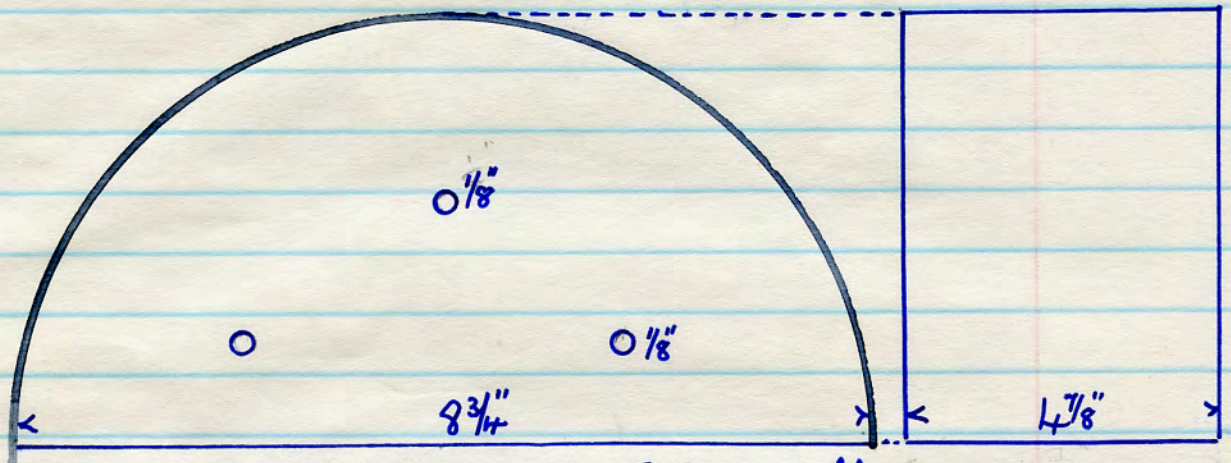

No name. 78 K 29 red T.C. 13 lbs
 moulder's marks DW

H088

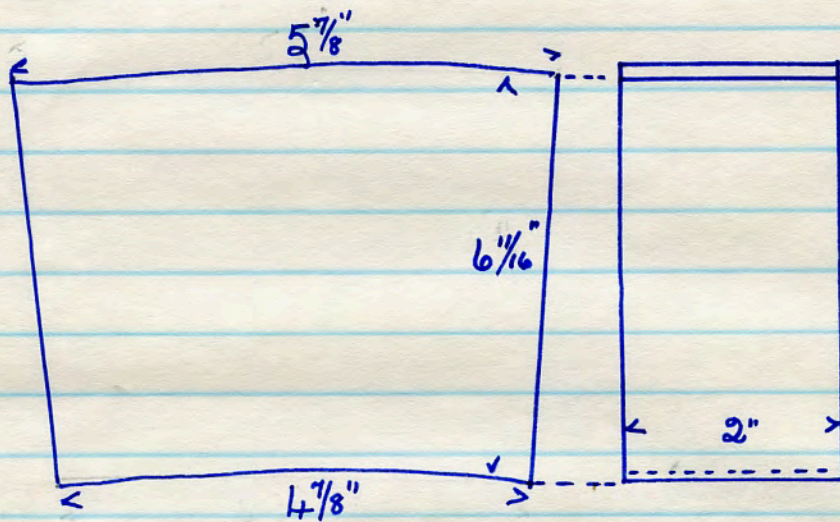

No name
 71 C 12
 red T.C
 7 lbs

H089

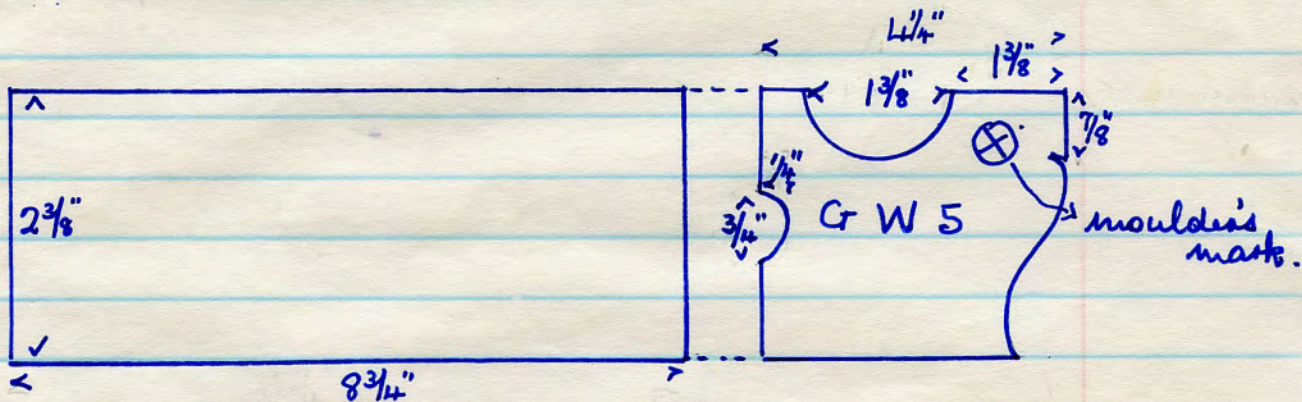

No name GW 5 red T.C. 7 lbs.

4090

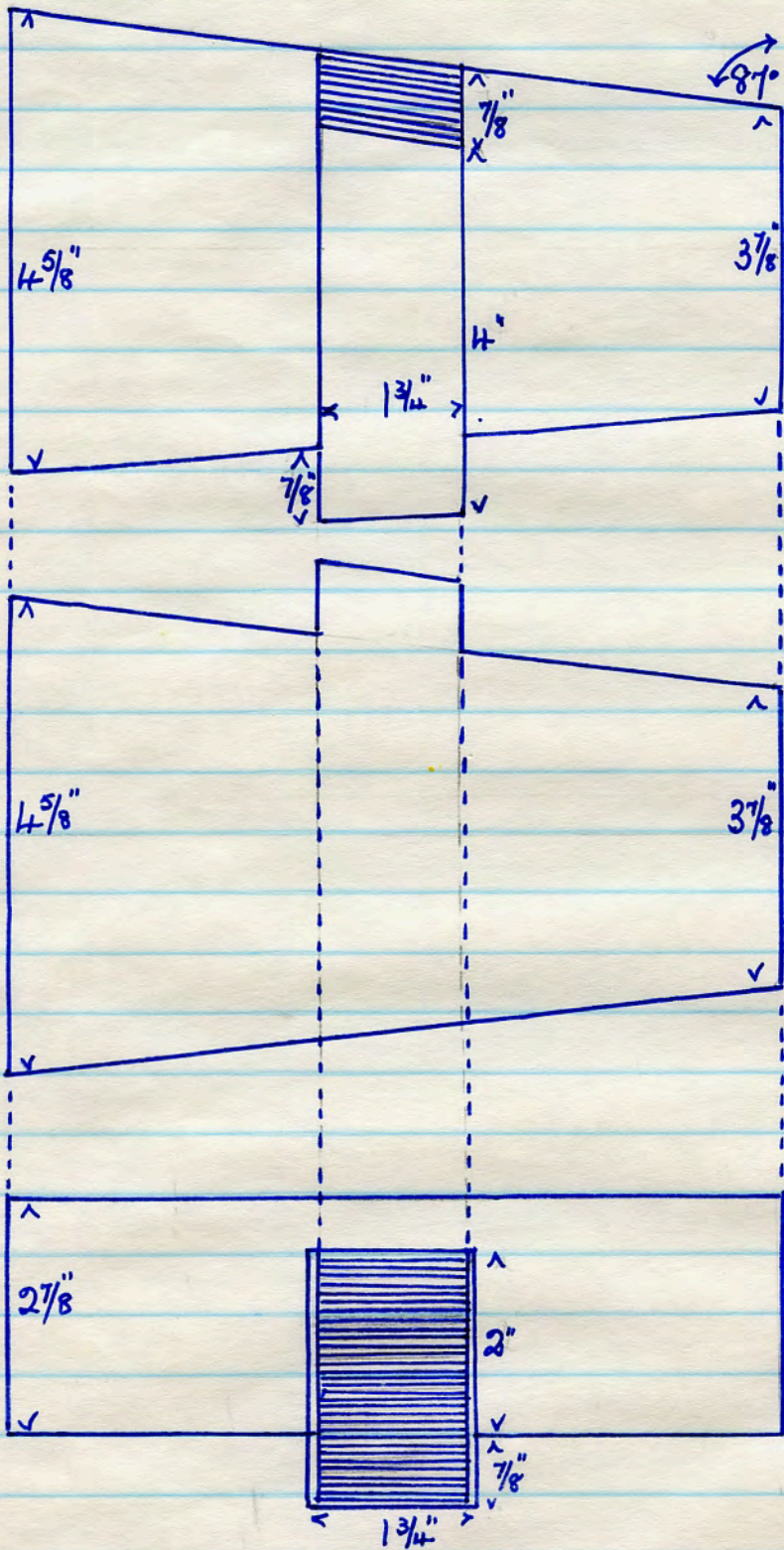

No name
71C 379
red T.C.
9 lbs

JC moulder's mark.

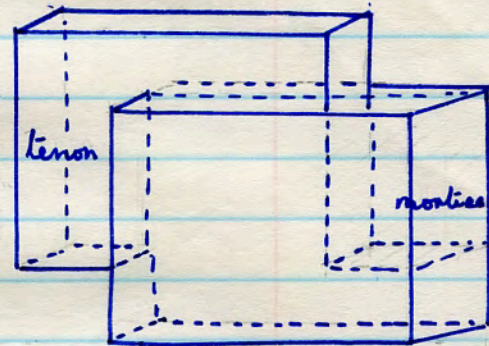

Acclton Mori dem. site 6. 12. '88

4091

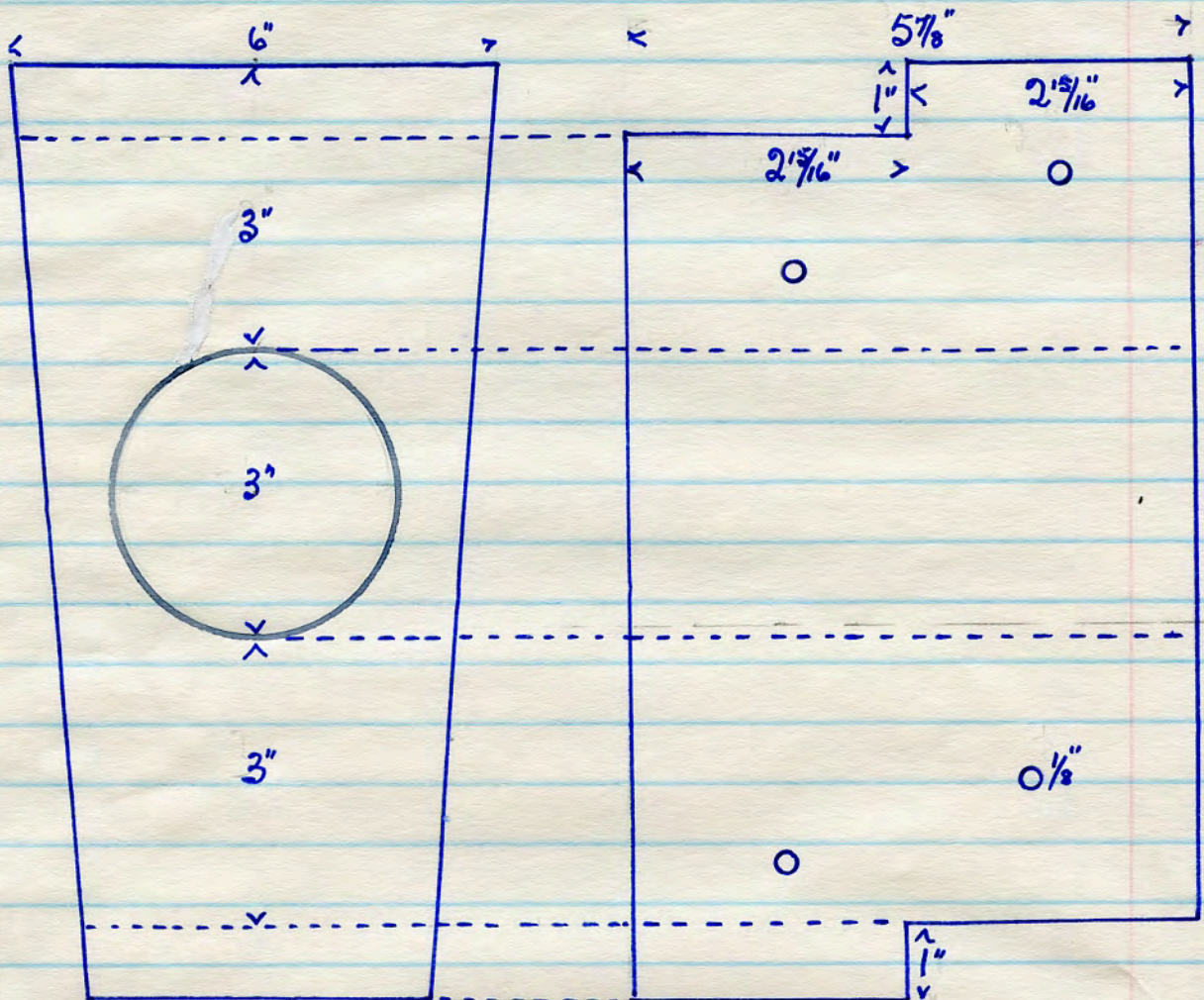

No name 71 C 382 red T.C. 20 1/2 lbs.

HB moulder's mark.

Acpton Mori dem. site 6. 12. '88

4092

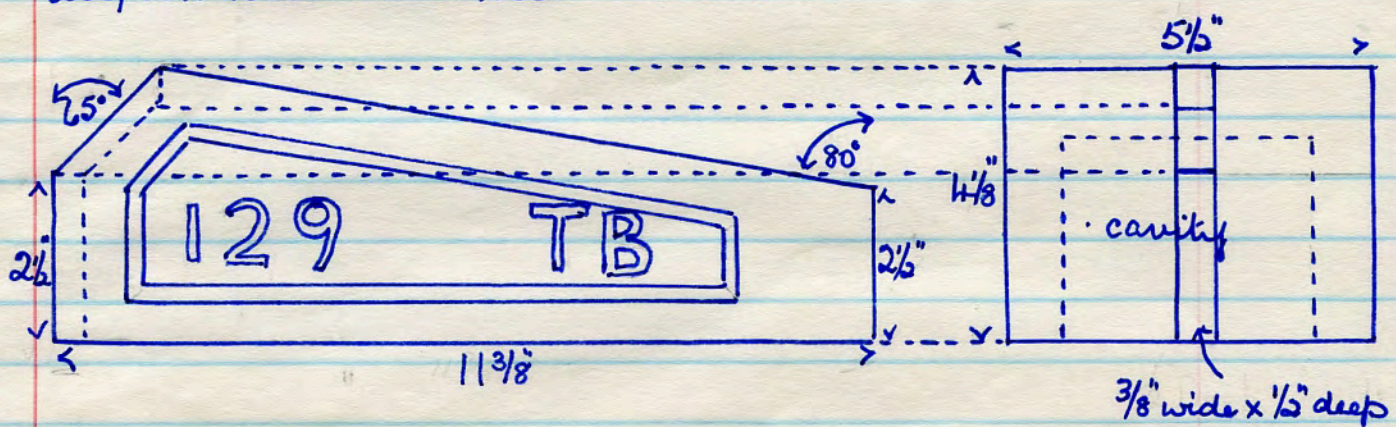

No name 129 TB red T.C 14 lbs

Acpton Mori dem. site 7. 12. '88

4093

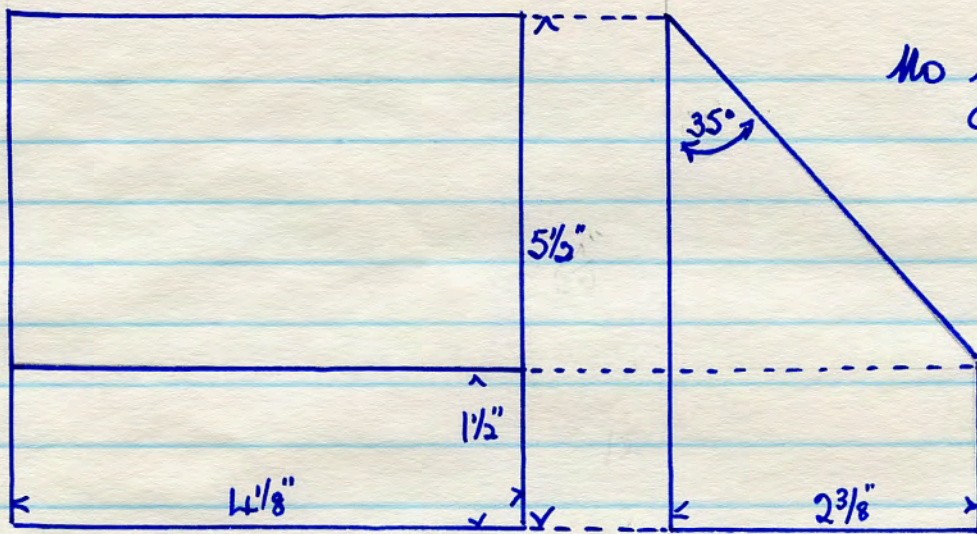

No name
 99B 241
 red T.C.
 4 lbs.

4094

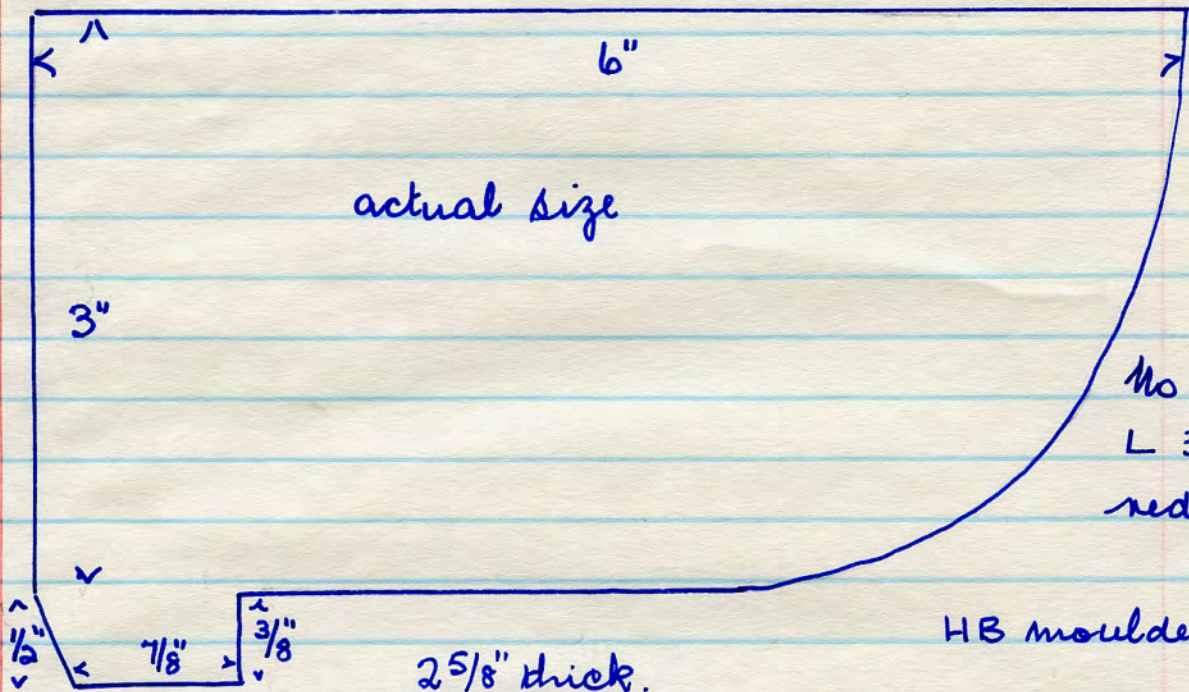

No name
 L 36 U
 red T.C.
 4 lbs.

HB moulder's mark

4095

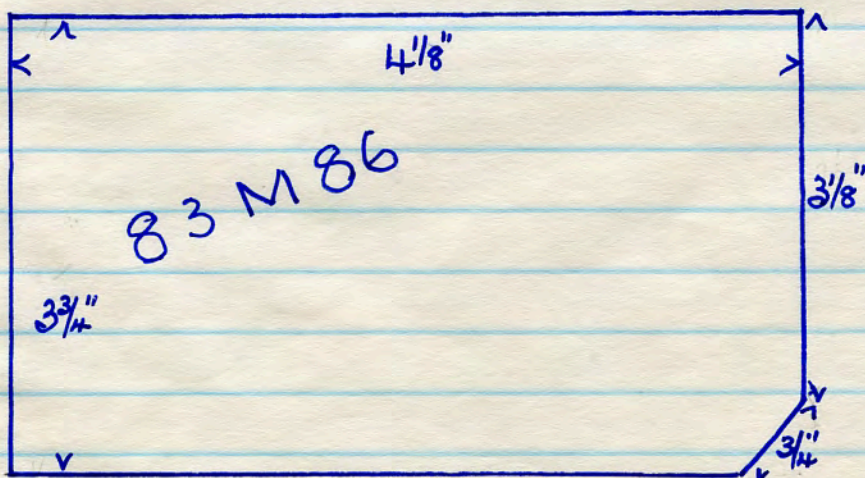

No name
 83 M 86
 red T.C.
 4 lbs
 2 3/4" thick.

All from Acpton Mori dem. site 7. 12. 88

No name 99B 230 red T.C. 10 lbs.

4096

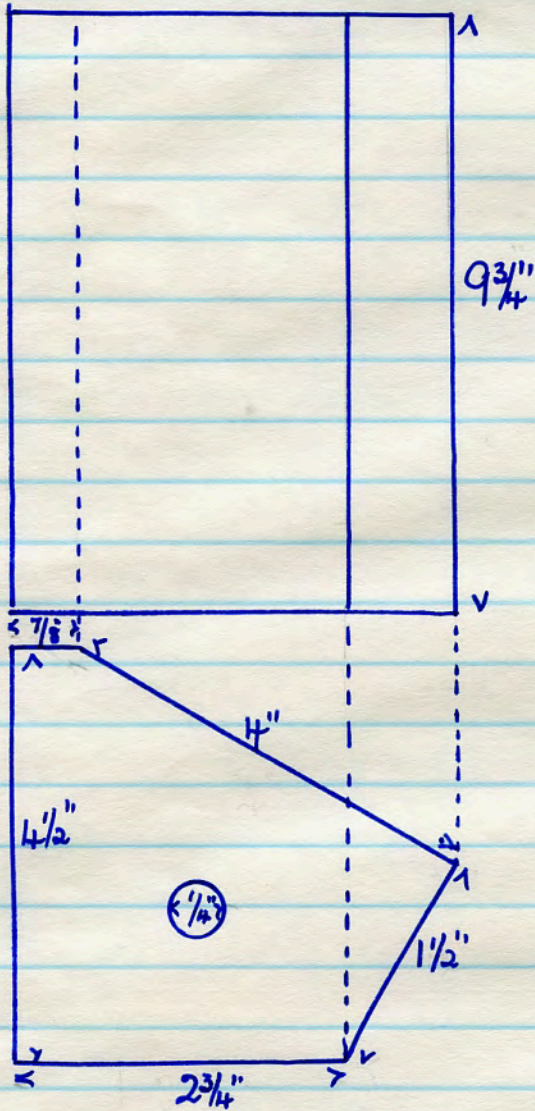

Acclton Mori dem. site
7. 12. '88

No name 813 Z7
red T.C. 4 lbs

4097

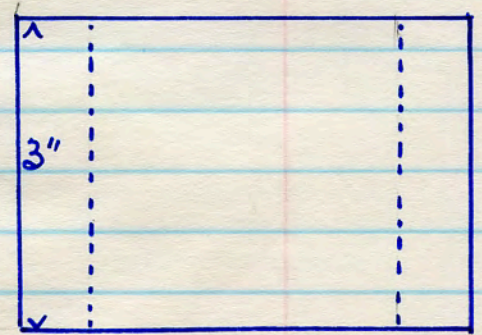
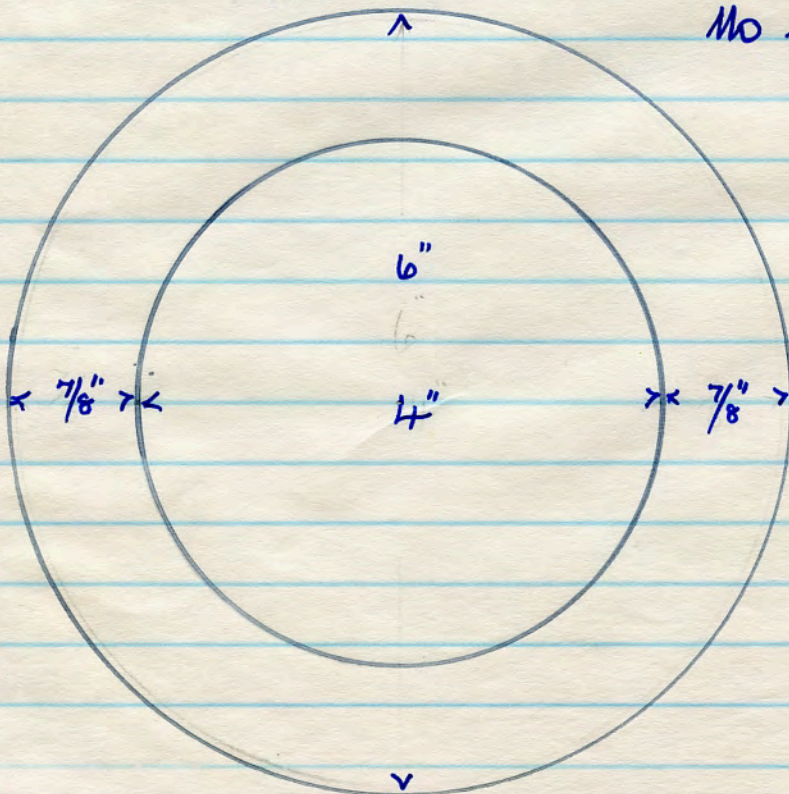

Acclton Mori dem. site
7. 12. '88

4098

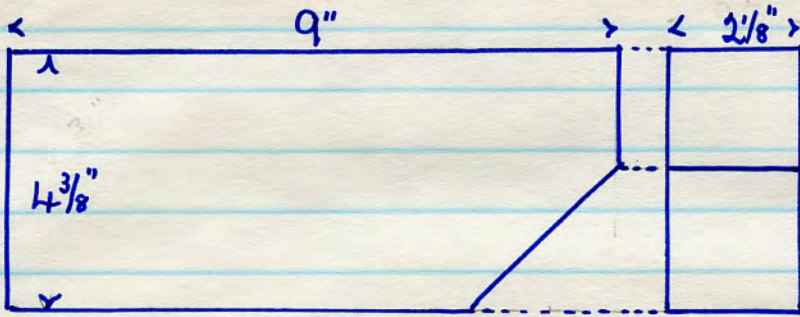

No name 5R2
red T.C 7lbs.

4099

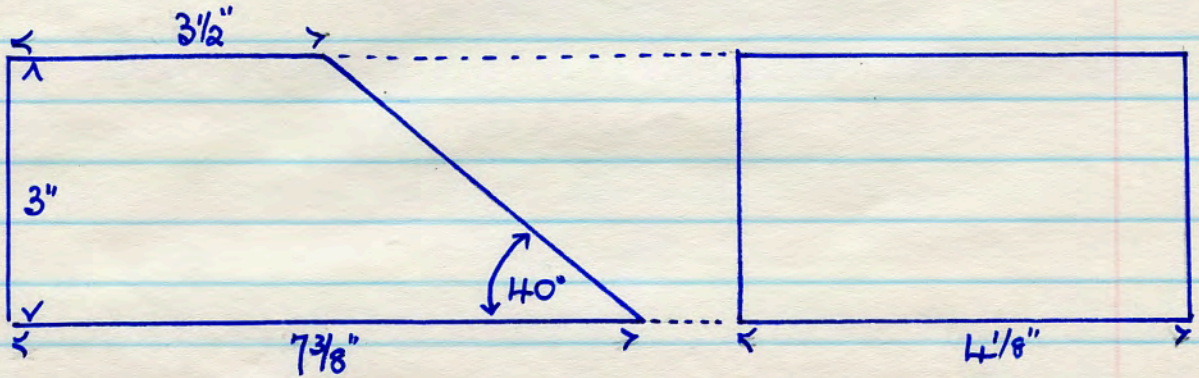

No name 99B 234 red T.C 7lbs

4100

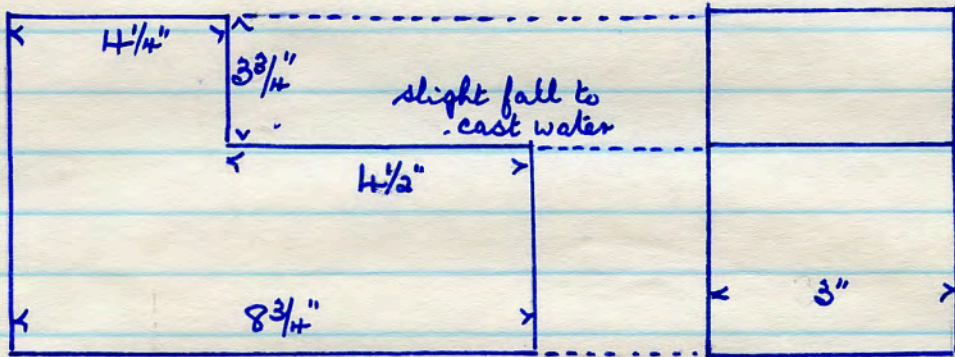

No name 99B 279 red T.C

14 lbs.

Acfton Moss dem. site 7. 12. '88

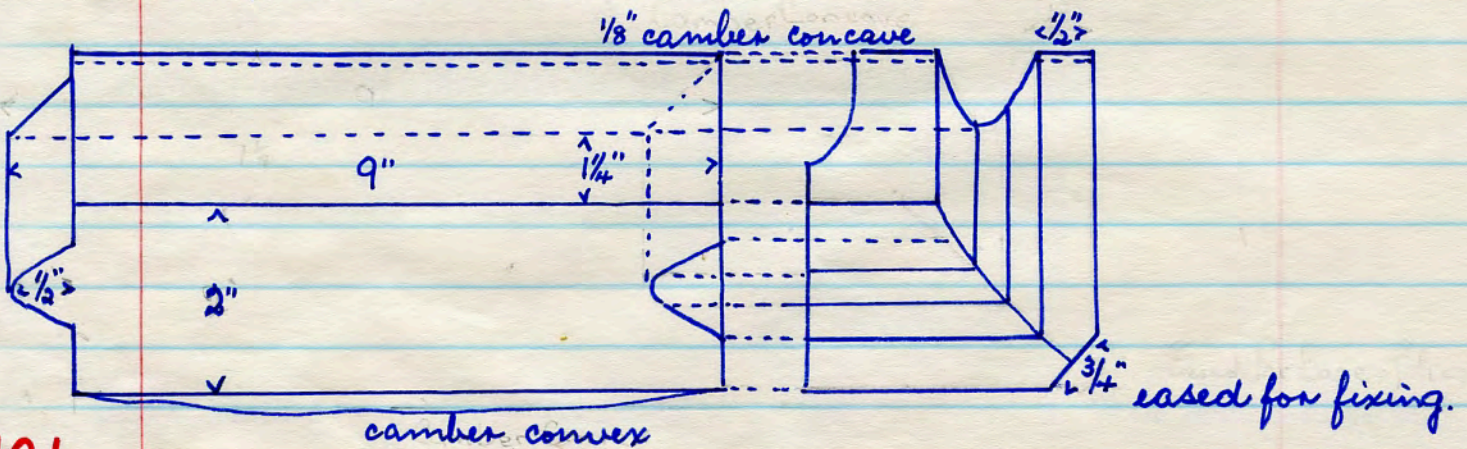

4101

No name 17L1 red T.C. 6 1/2 lbs. JC moulder's mark.

4102

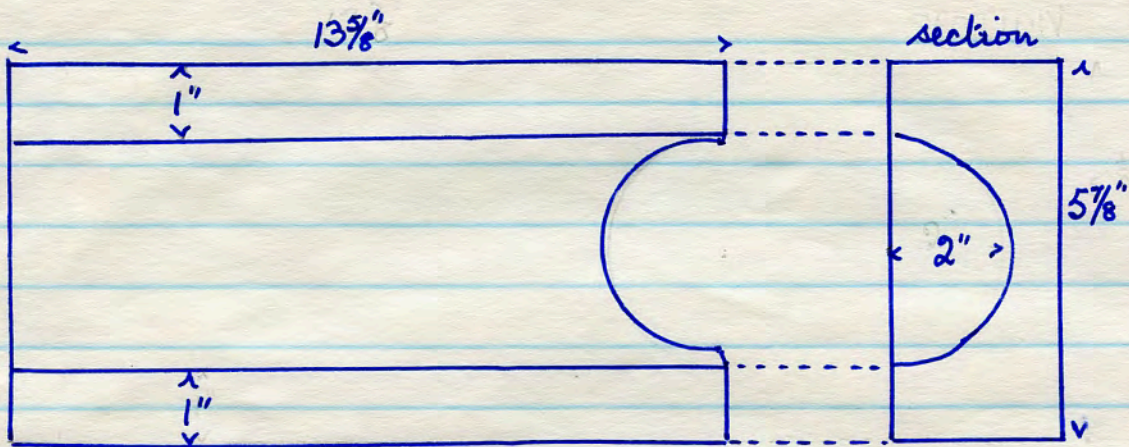

No name
76 OW
red T.C
trough
14 lbs.

4103

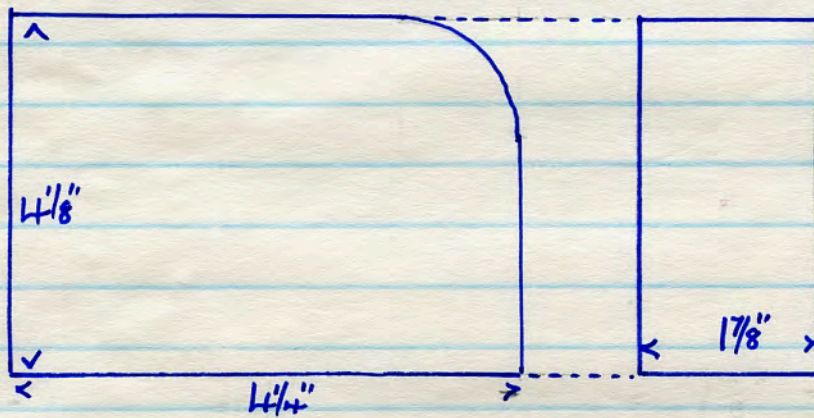

No name
99B 249
red T.C
3 lbs

4104

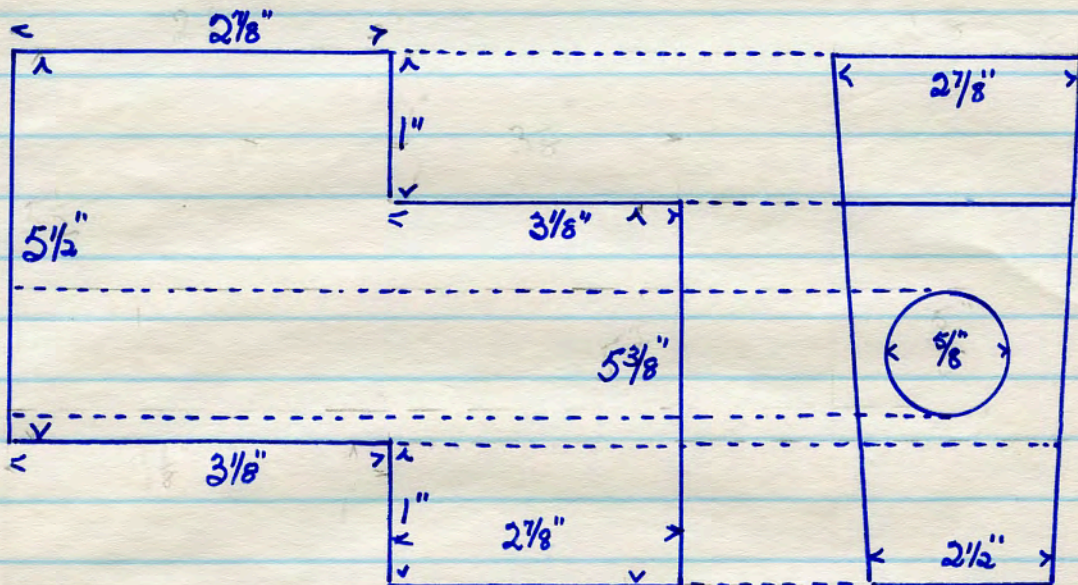

No name
71C 383
red T.C
7 lbs.

No name 38 H 29 X red T.C. 6 lbs.

4105

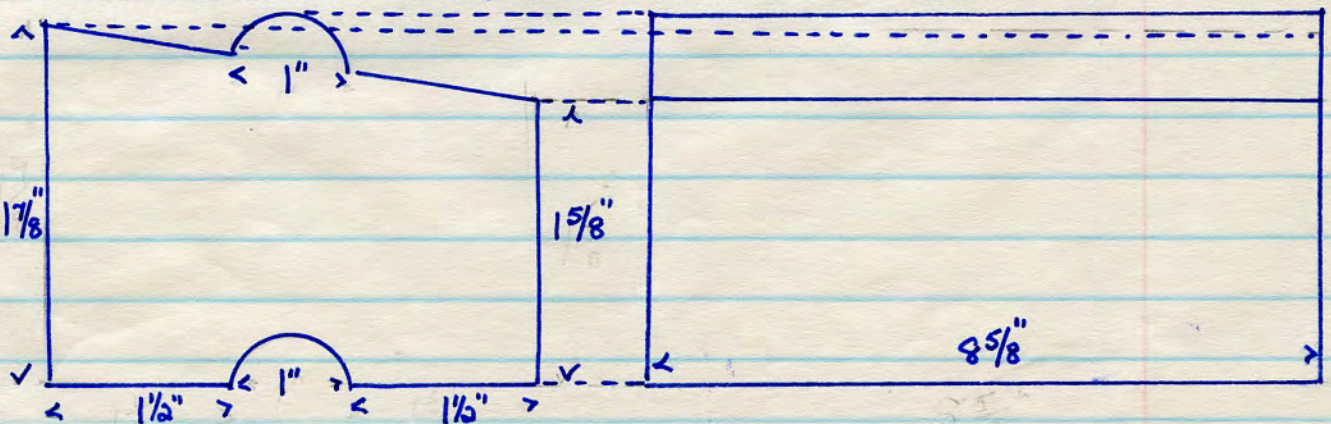

Acceptor Mori dem. site 8. 12. '88

No name 24H2
red T.C 12 lbs

H106

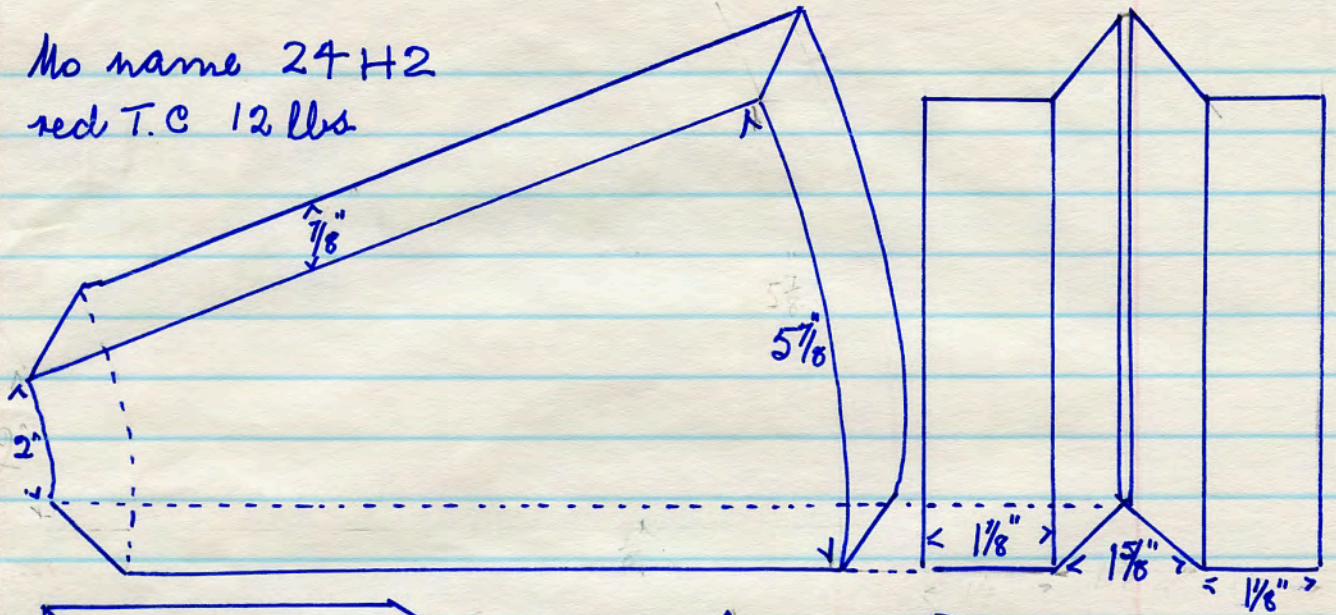

H107

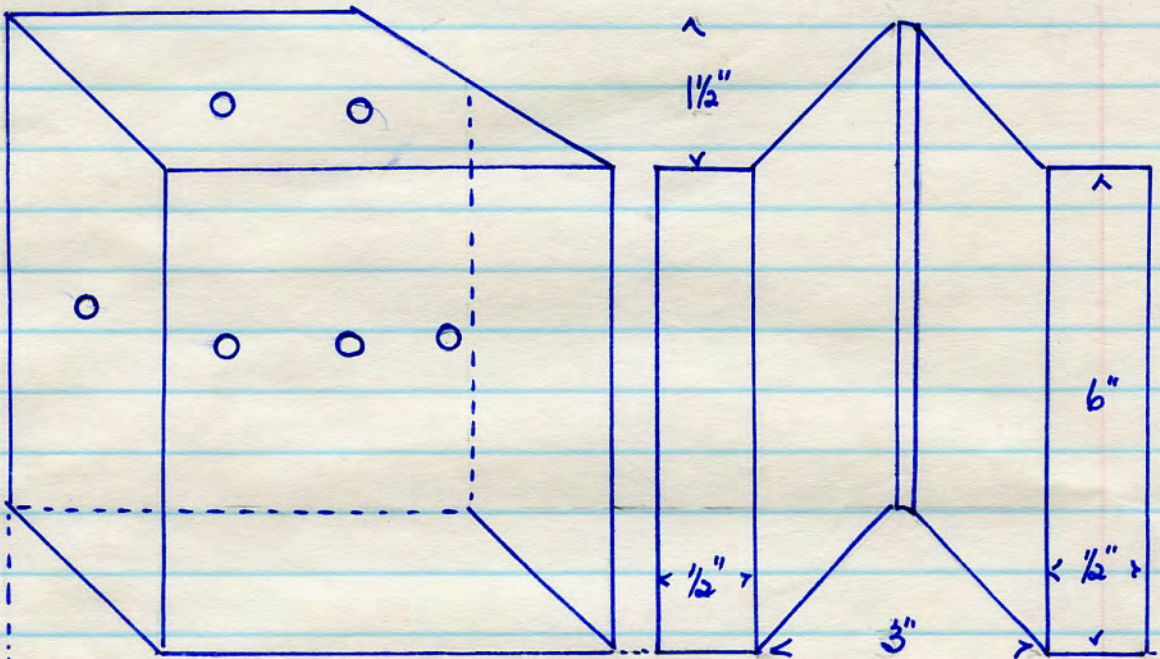

5/16" camber

No name 4PK
red T.C 17 lbs.
DW moulder's mark.

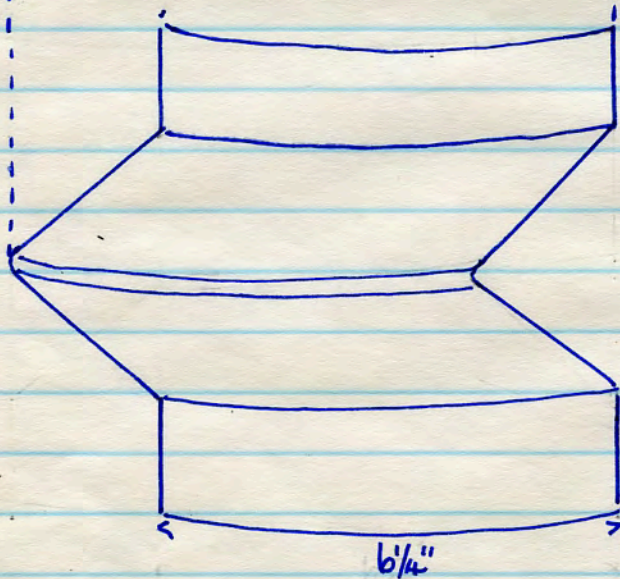

Acclon Mori dem. site 8. 12. '88

4108

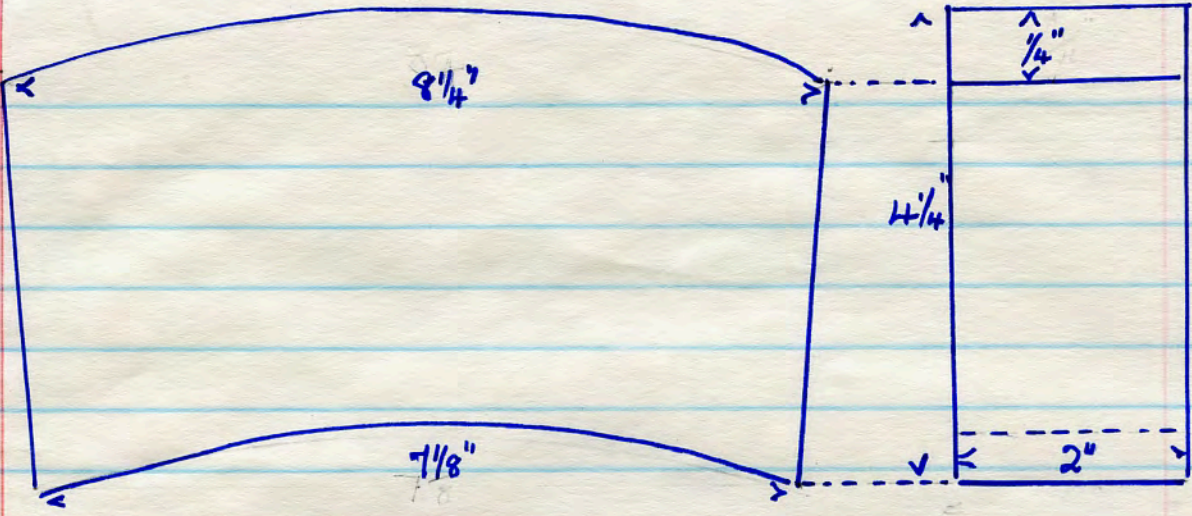

No name
 38/43
 red T.C
 5 1/2 lbs

No name
 183 U 21
 red T.C.
 12 1/2 lbs

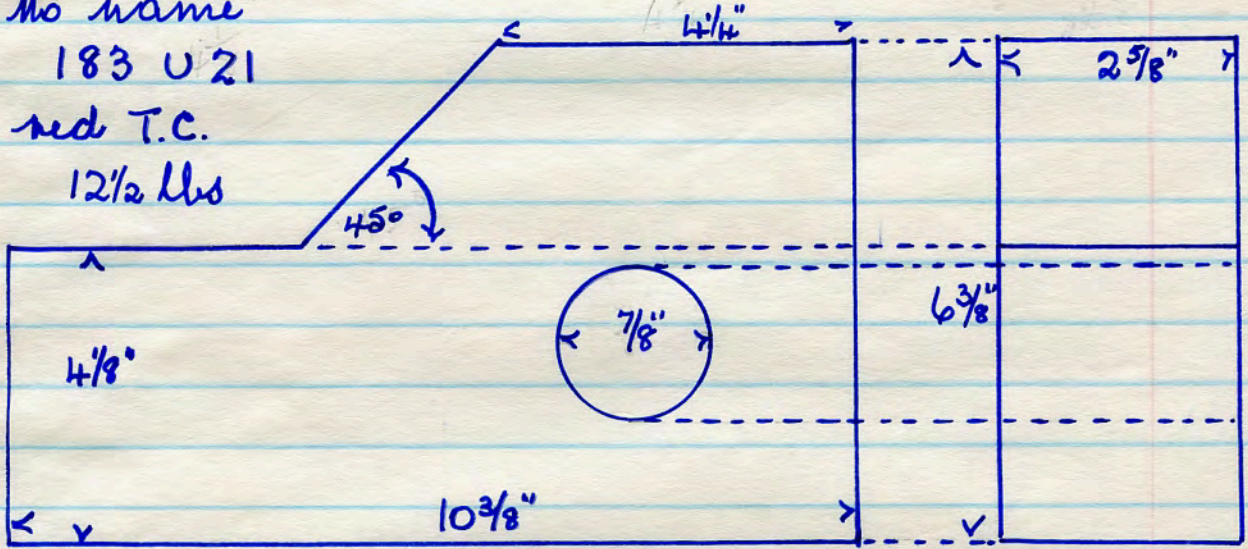

4109

No name
 3 H 1 A
 red T.C
 4 lbs

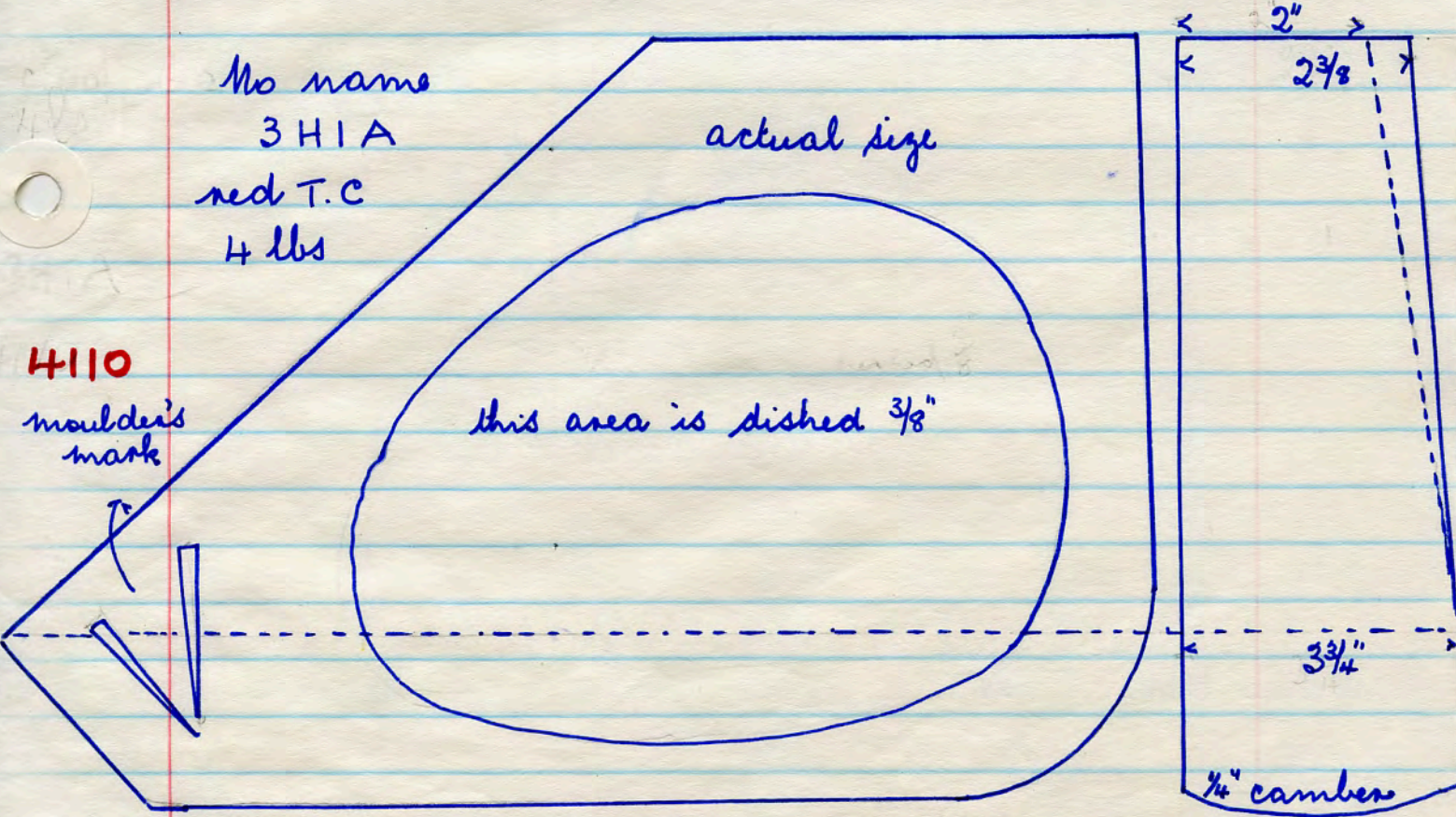

4110

moulder's mark

Acpton Mori dem. site 8. 12. '88

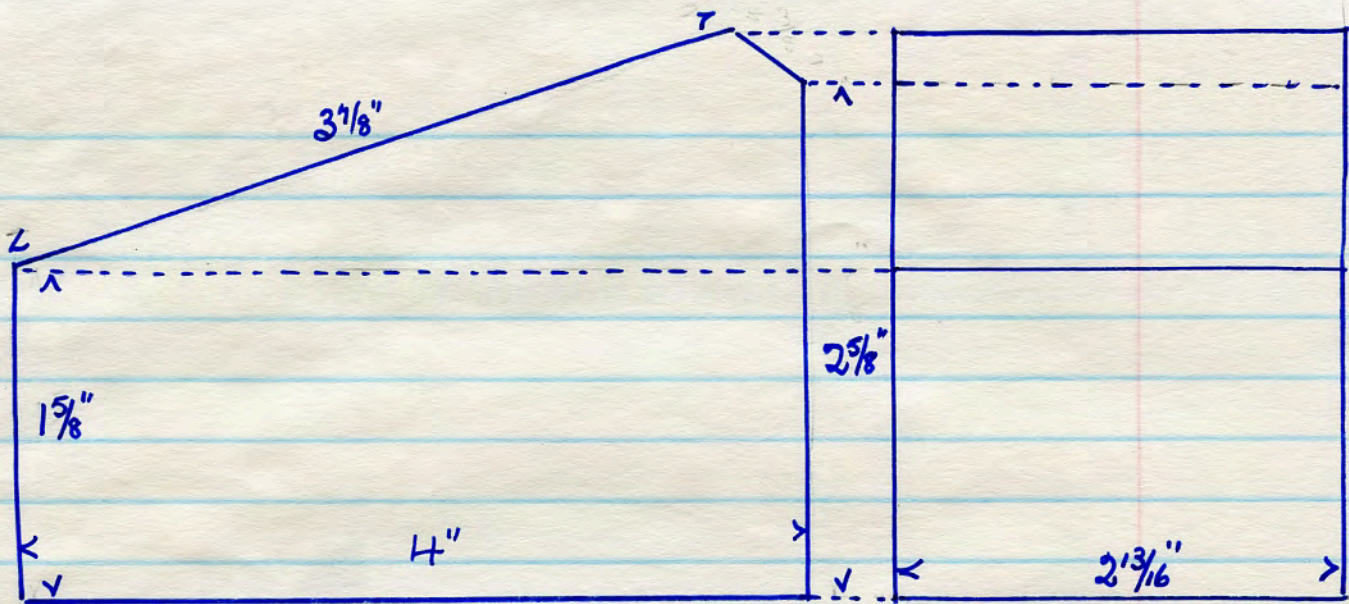

4111

No name 10C 210 red T.C. 2 1/2 lbs

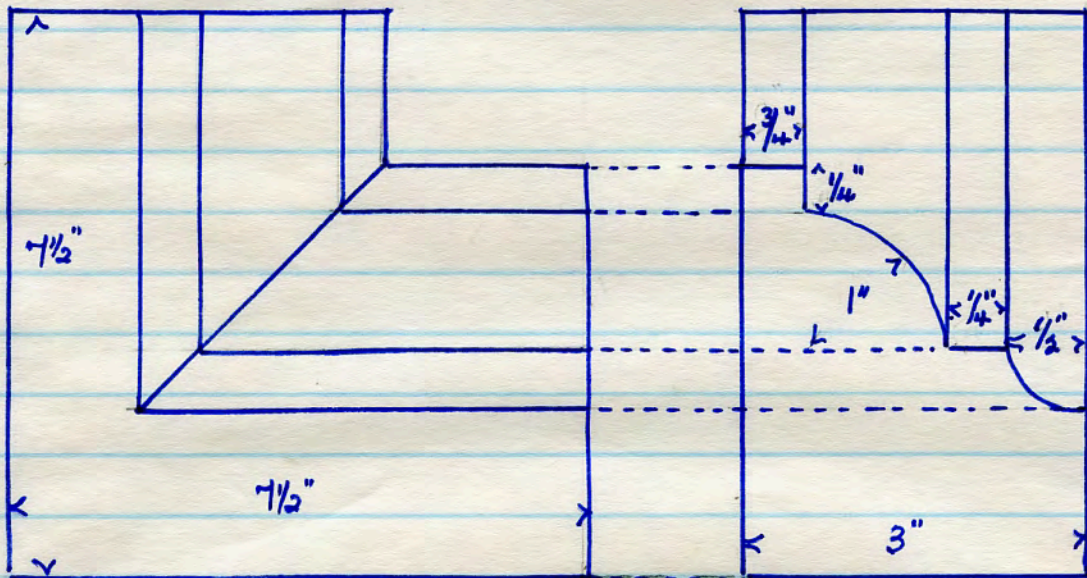

4112

No name 26 red T.C. 12 lbs

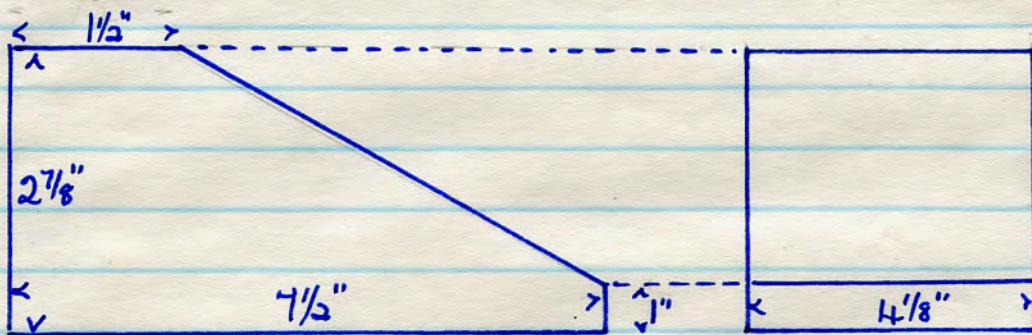

4113

No name 78 K 24 red T.C. 5 3/4 lbs

Acpton Mori dem. site 9. 12. '88

No name 86 TIL red T.C. $12\frac{3}{4}$ lbs.

4114

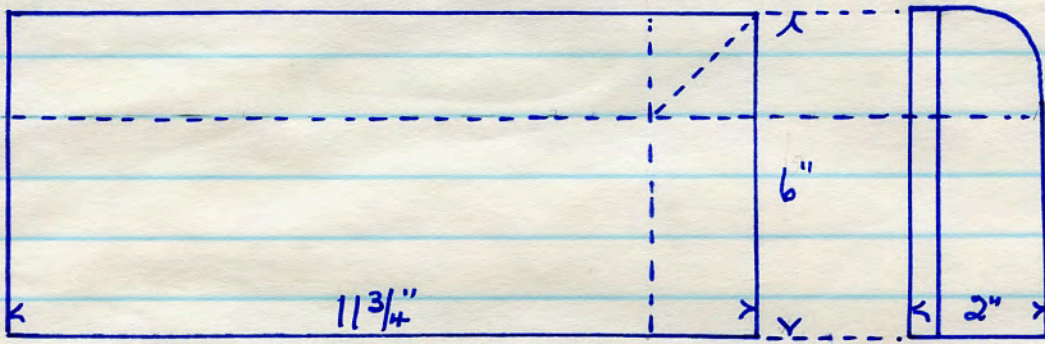

No name TIC 74
red T.C. 20 1/2 lbs
J1 moulder's mark

4115

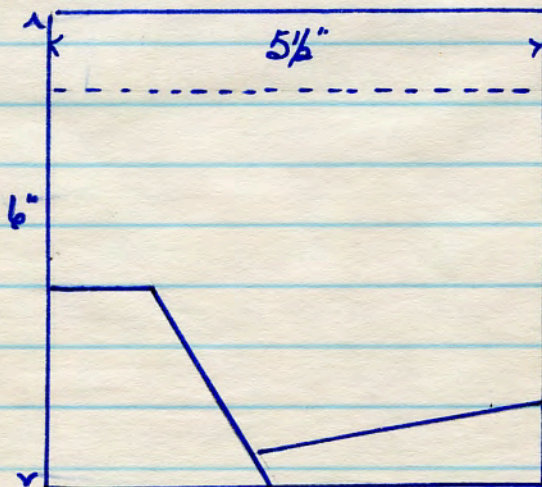
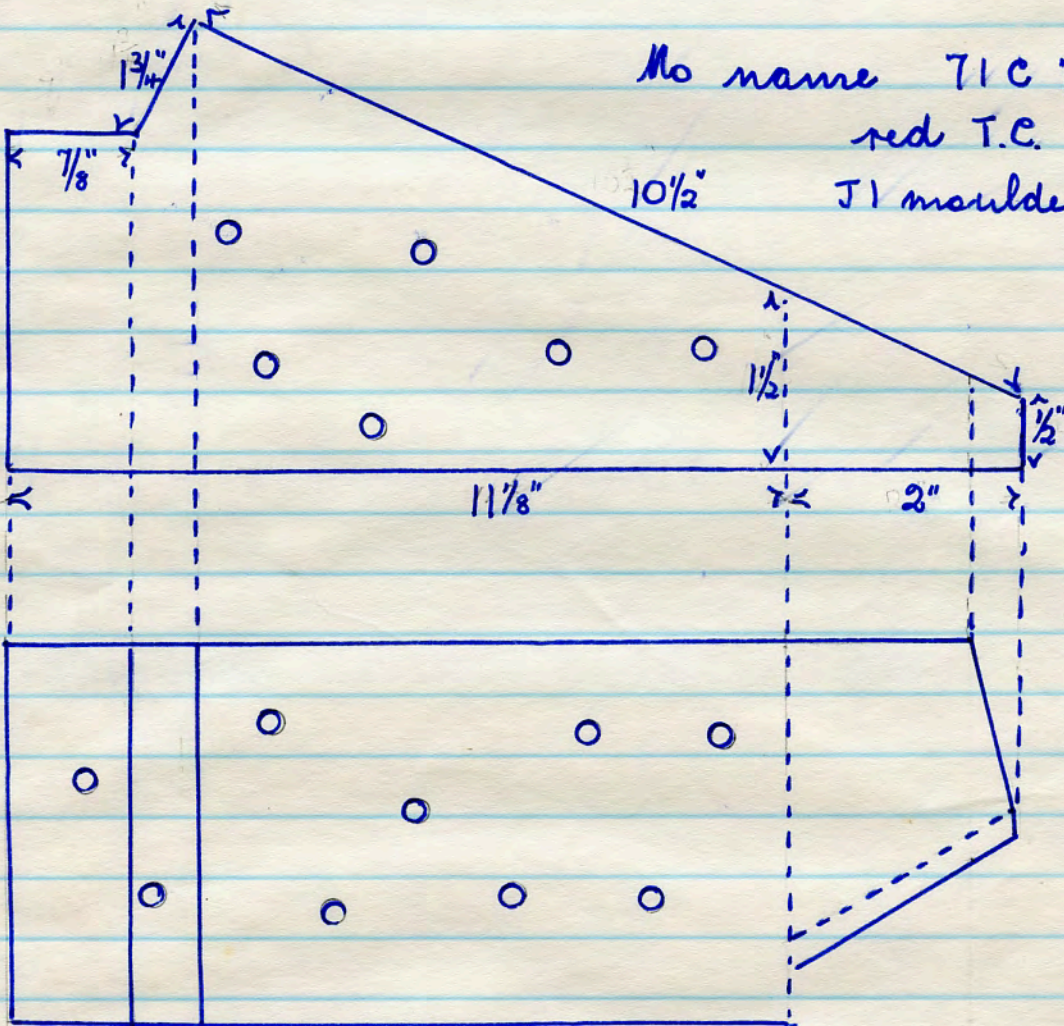

no name 235 Y red T.C 21 lbs
 one of a pair which fit together by half lap joints

4116

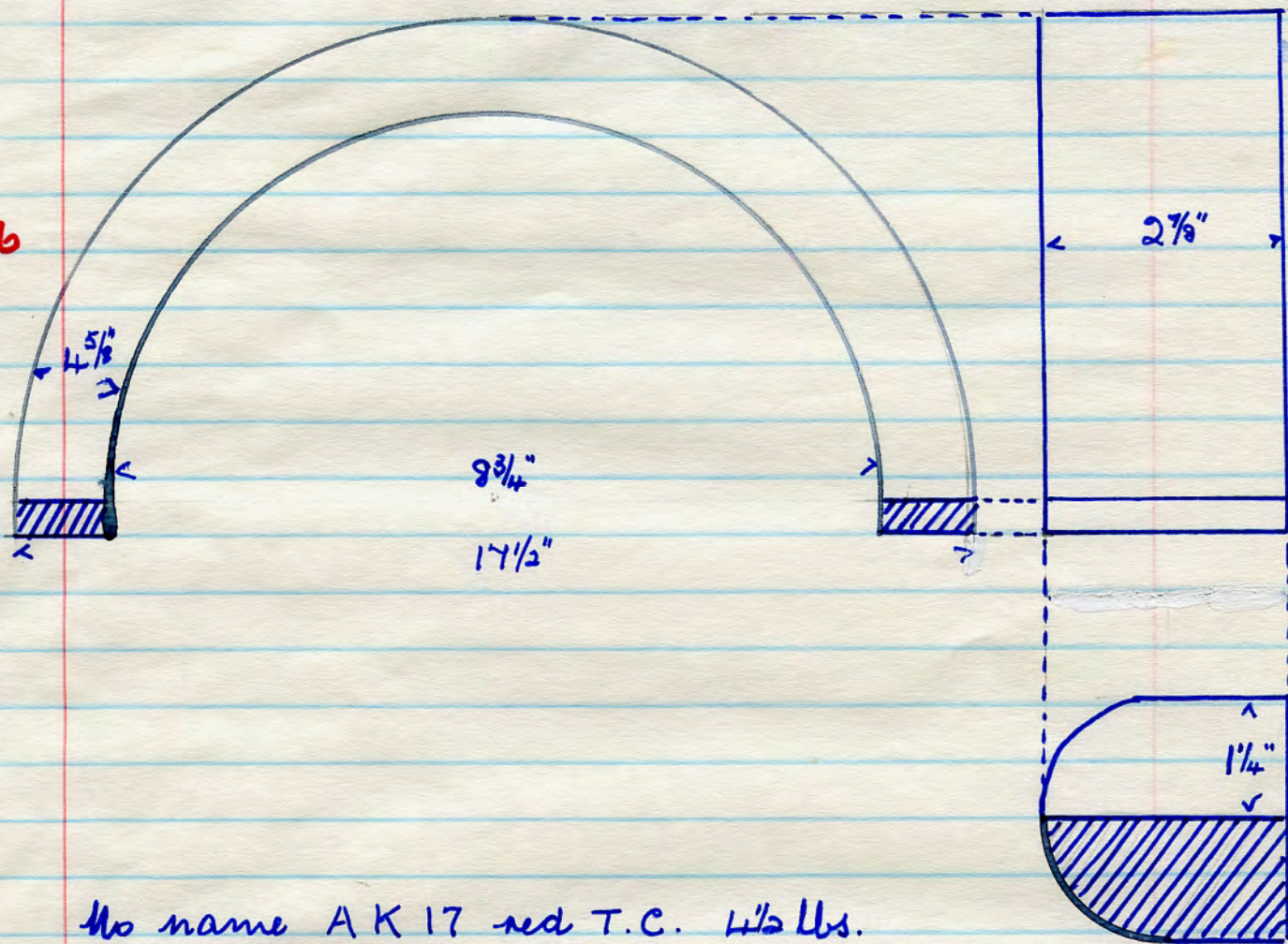

no name AK 17 red T.C. $4\frac{1}{2}$ lbs.
 Acepton Kosi dem. site 12. 12. '88

4117

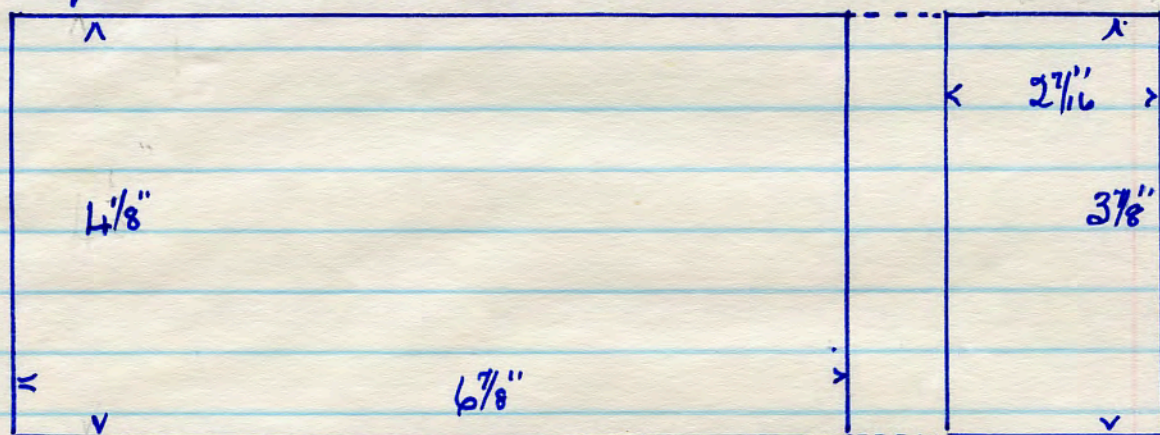

4118

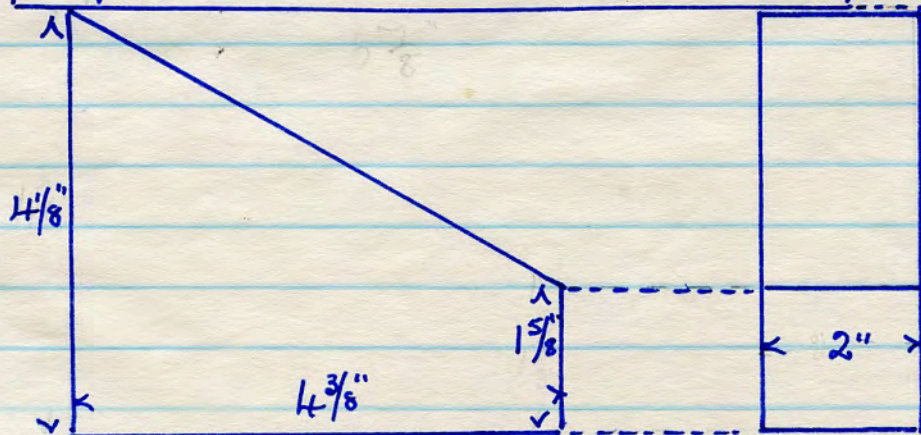

no name
 19 K J 21
 red T.C
 2 lbs.

4119

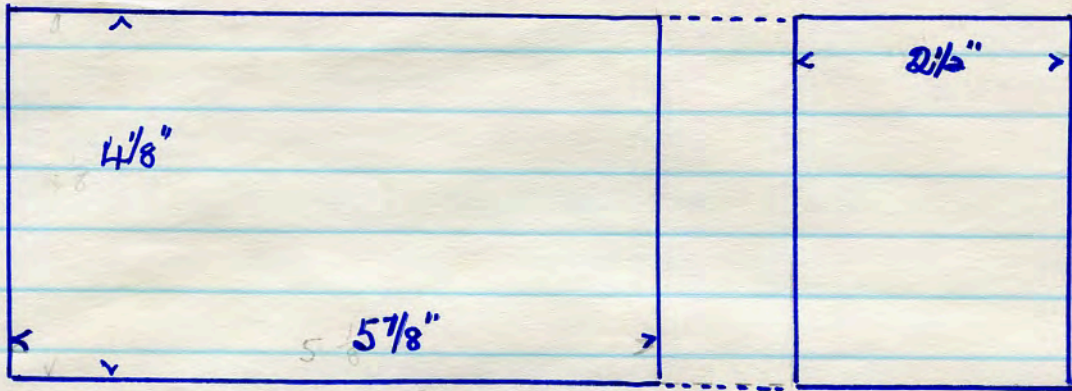

No name CBA red T.C. $5\frac{1}{2}$ lbs.

Accpton Nori dem. site. 12. 12. '88

ACCRINGTON NORI red jamb or corbel

9 lbs $9" \times 4\frac{3}{8}" \times 3"$

single panel obv. only, plain rev.

letters incised obv

Accpton Nori dem. site 30. 10. '88



4120

ACCRINGTON NORI $2\frac{5}{8}$ red closer, made of T.C.

9 lbs $9" \times 4\frac{3}{8}" \times 2\frac{5}{8}"$

single panel obv. only.

2 large pressure points rev

letters incised obv. note N changed to V
 $2\frac{5}{8}$ in relief.

Accpton Nori dem. site 8. 12. '88

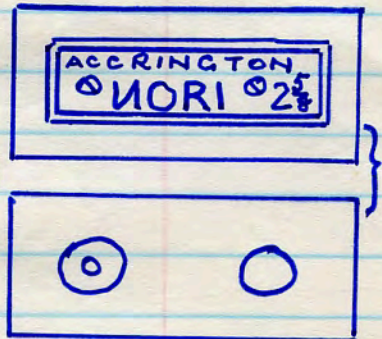

4121

HAWORTH red T.C.

10 lbs. $9" \times 4\frac{3}{8}" \times 3"$

no panels

letters incised 5 times obv.

Accpton Nori dem. site 8. 12. '88

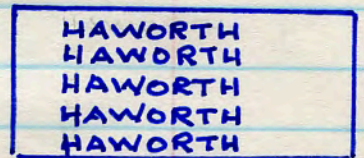

4122

C B D red T.C.

11 lbs. $10" \times 4\frac{1}{2}" \times 3"$

single shallow panel rev. $\frac{1}{16}$ " deep
letters scribed obv.

Accpton Nori dem. site 8. 12. '88

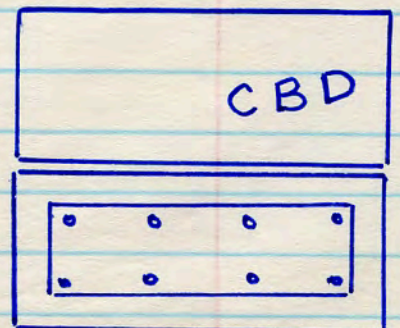

4123

CHK red T.C

8 1/2 lbs 8 3/4" x 4 3/8" x 3"

H124 small panel obv 2 1/4" x 1 1/4" x 1/8" deep.
letters incised obv.

Acpton Mori dem. site 8. 12. '88

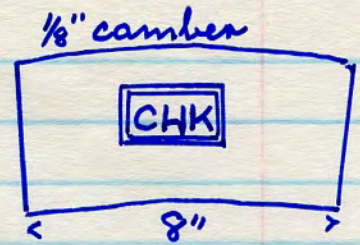

CHH red T.C

8 1/2 lbs 8 5/8" x 4 1/8" - 3 1/2" x 2 7/8"

H125 small panel obv. 2 1/4" x 1 1/4" x 1/8" deep
letters incised obv.

Acpton Mori dem. site 8. 12. '88



E red T.C.

9 1/2 lbs. 8 3/4" - 8 3/8" x 4 3/8" x 2 7/8"

H126 small panel obv. 2 1/4" x 1 1/8" countersunk
letter incised deeply, obv.

Acpton Mori dem site 9. 12. '88

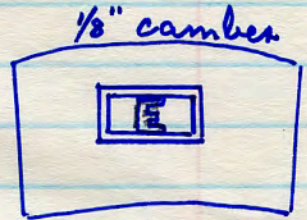

No name 19QP red T.C.

8 1/2 lbs

H127

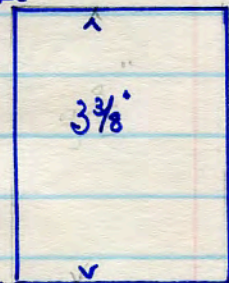
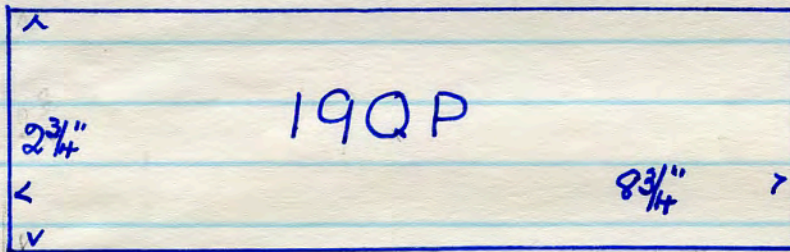

H128

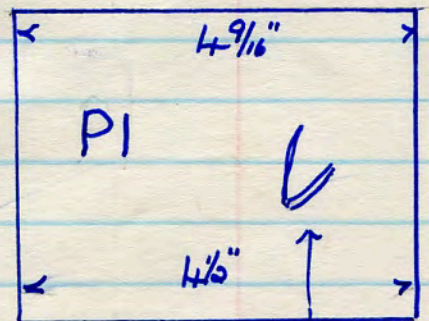
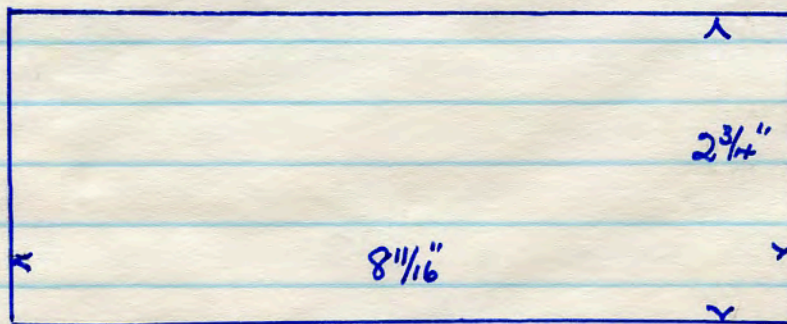

No name PI red T.C. 10 1/2 lbs.

Acpton Mori dem. site 13. 12. '88

4129

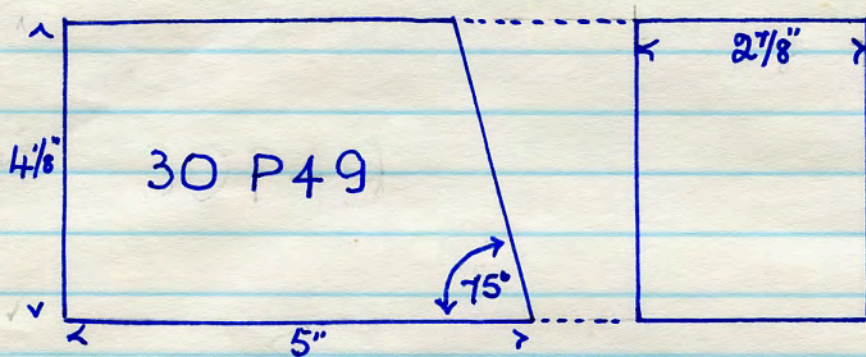

No name
 30 P 49
 red T. C.
 5 1/2 lbs.

4130

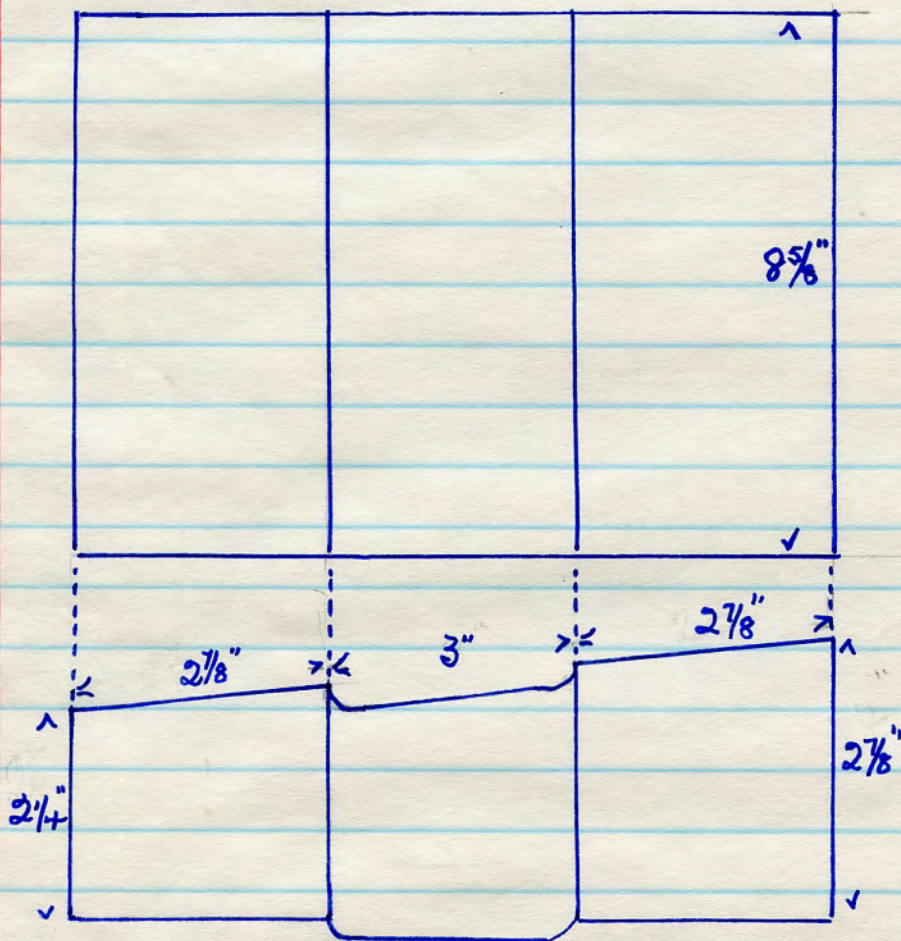

No name
 43 N 7 22
 red T. C
 16 lbs.
 J1 moulder's mark.

Accepton Mori dem. Site 13. 12. '88

4131

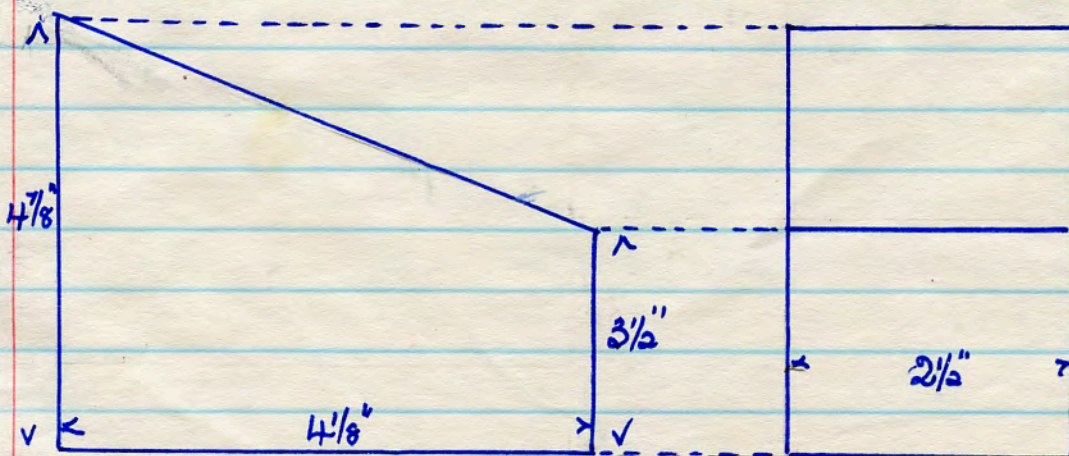

No name
 FDD 19
 red T. C
 4 lbs.

No name 130 TA 8 lbs
dark brown T.C.

4132

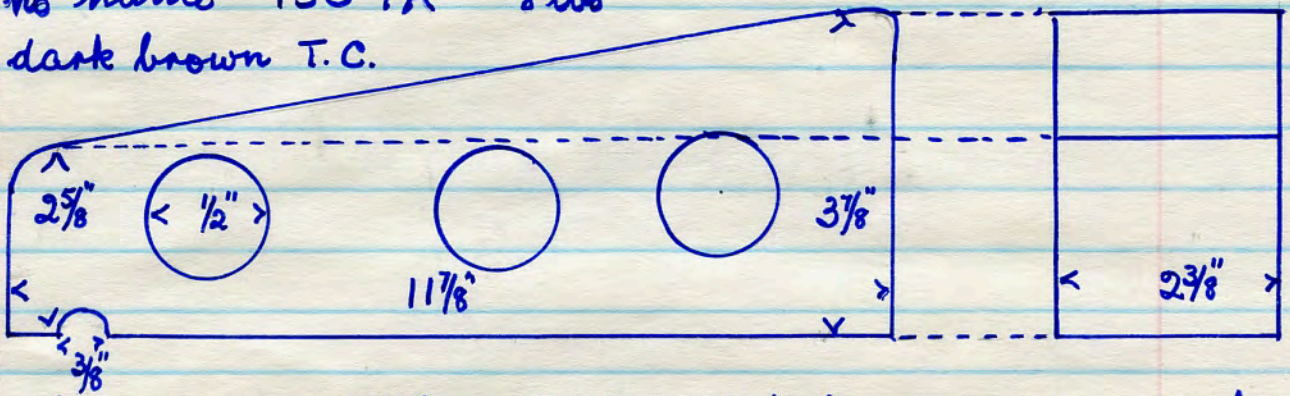

No name 249 TG 4R dark brown T.C. 10 lbs.

4133

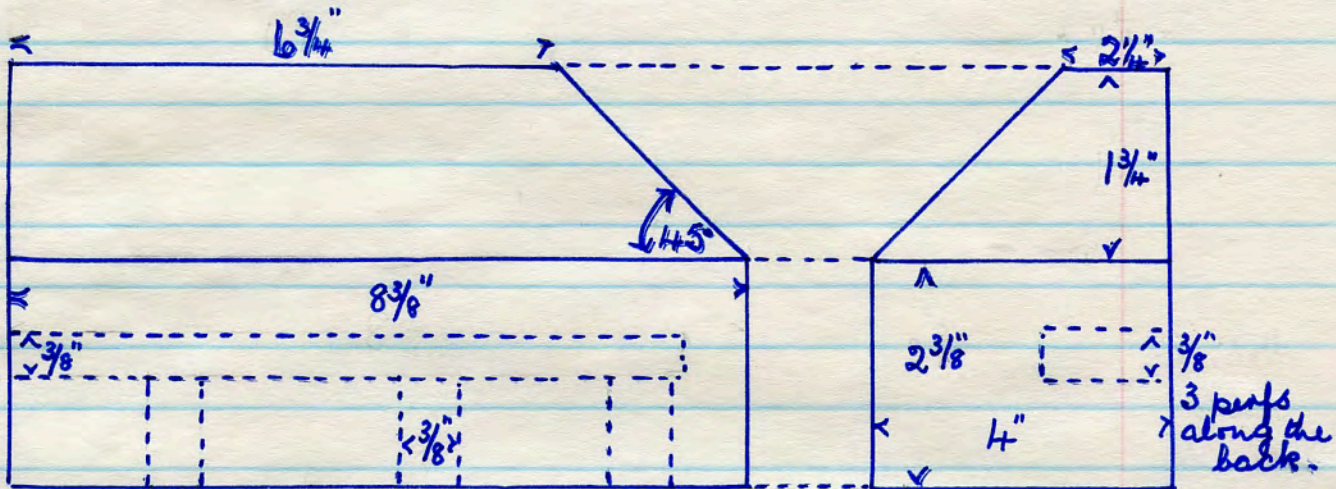

4134

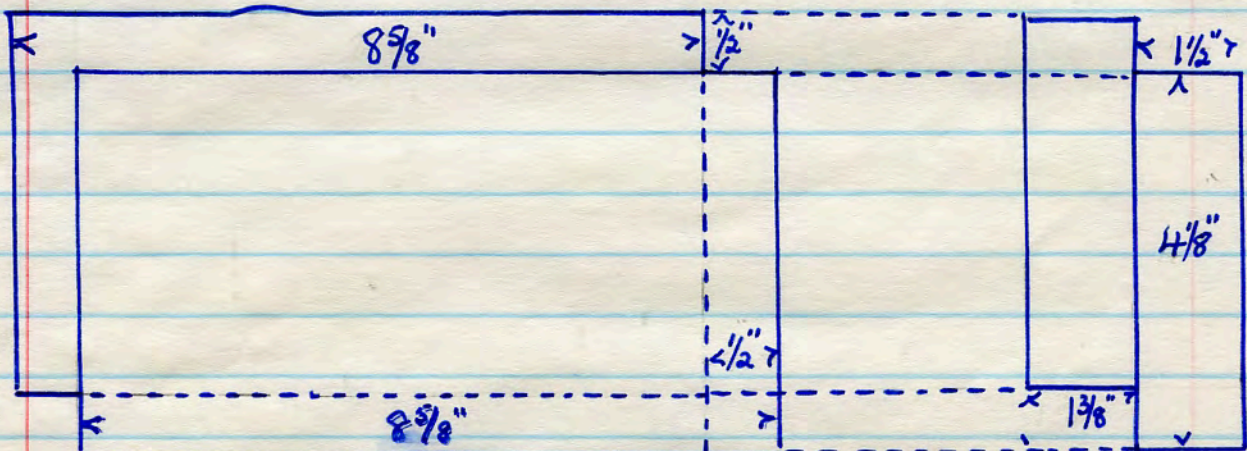

No name 32 G1 red T.C. 9 lbs

4135

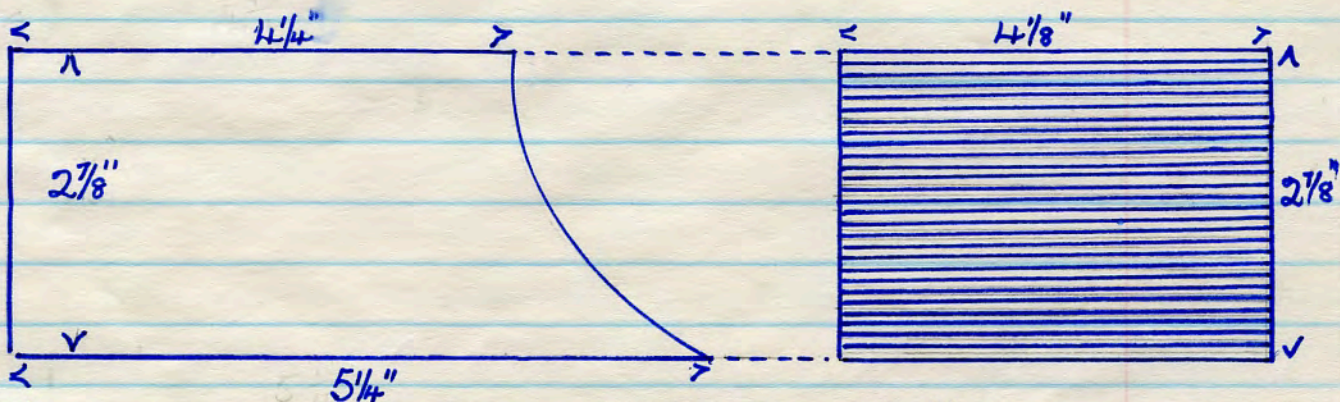

No name 14 E 656 red T.C. 5 1/2 lbs.
Acc/ton Mori dem site. 14. 12. '88

No name 52 B 21 red T.C. 5 1/2 lbs.

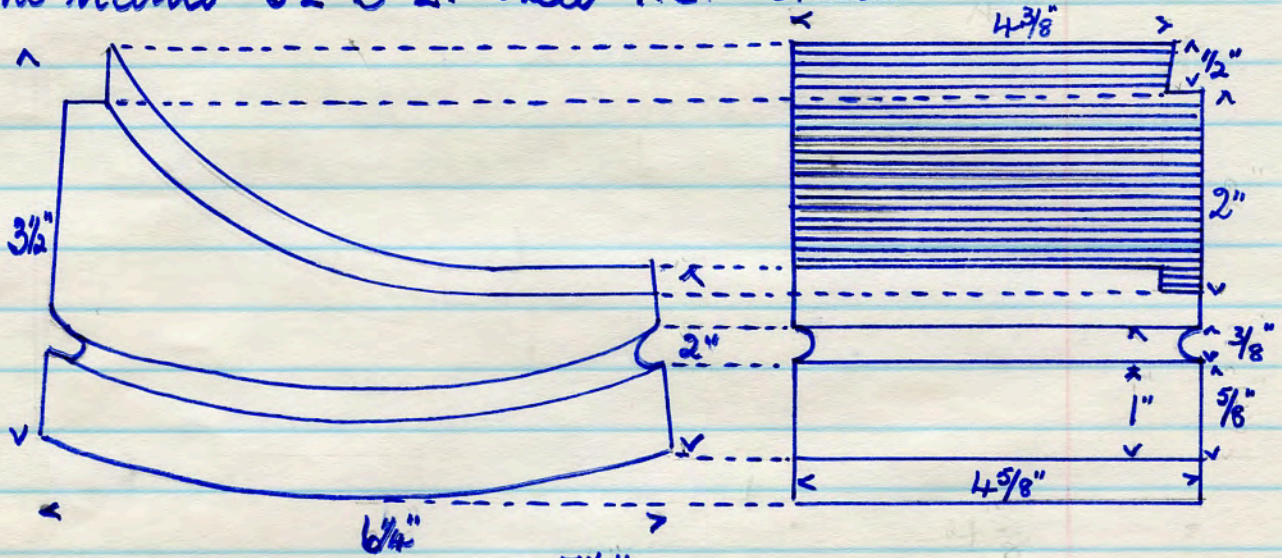

4136

No name 10P red T.C. 7 lbs.

actual size

10P

2 7/8"

4" long.

4138

Acc/ton Mossi dem. Site 16. 12. 88.

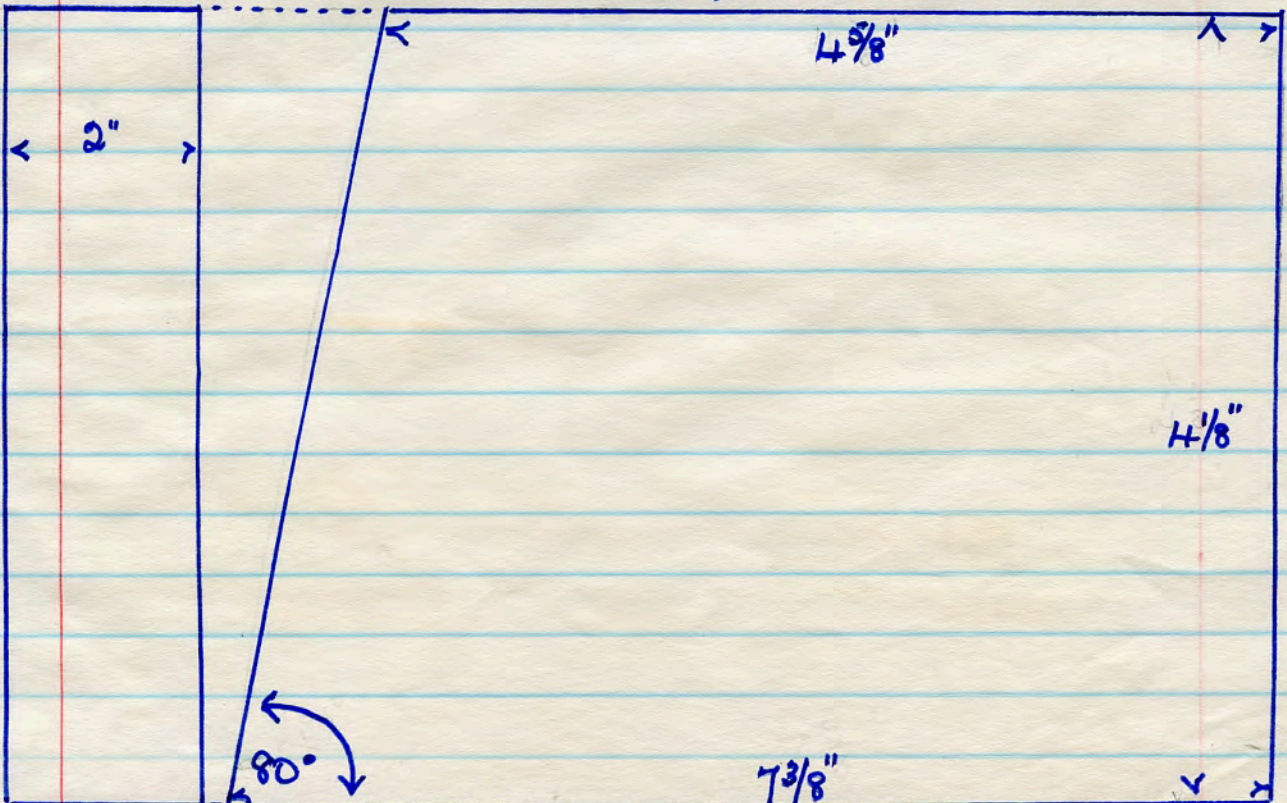

No name
FBB3
red T.C.
5 lbs

4 1/8"

7 3/8"

4139

No name. no number. red T.C. trough 43 lbs.

4137

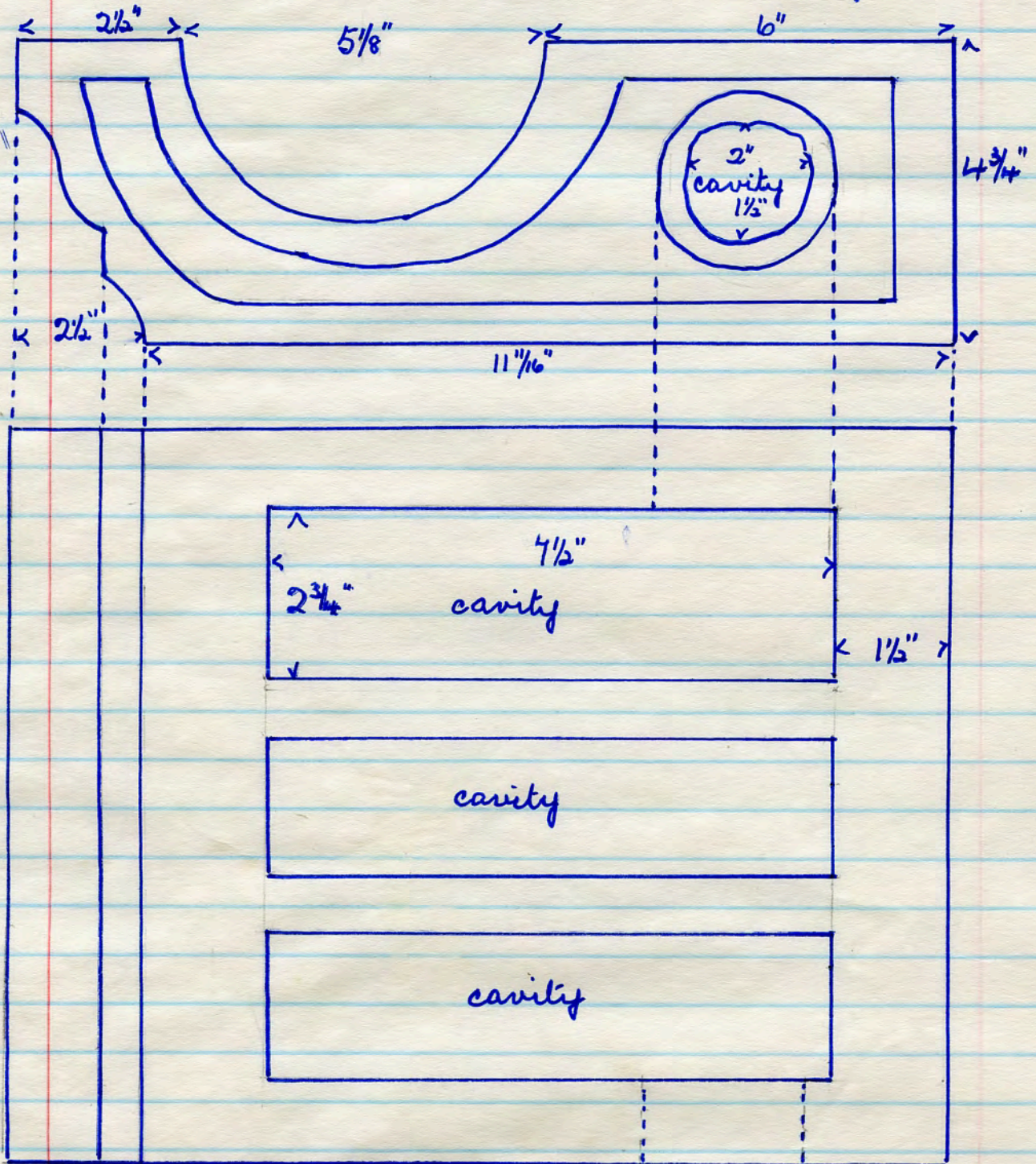

Acclton Mori dem. site 2. 11. '88



All from Acc/Ton Moni dem. site 16. 12. '88

No name. no number red T.C. 7 lbs.

4140

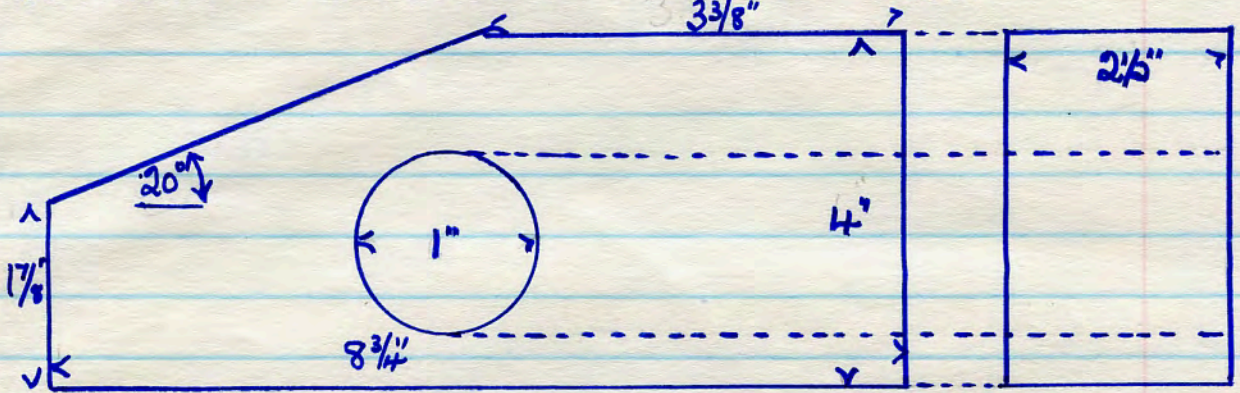

No name 26 12 red T.C. 9 1/2 lbs.

4141

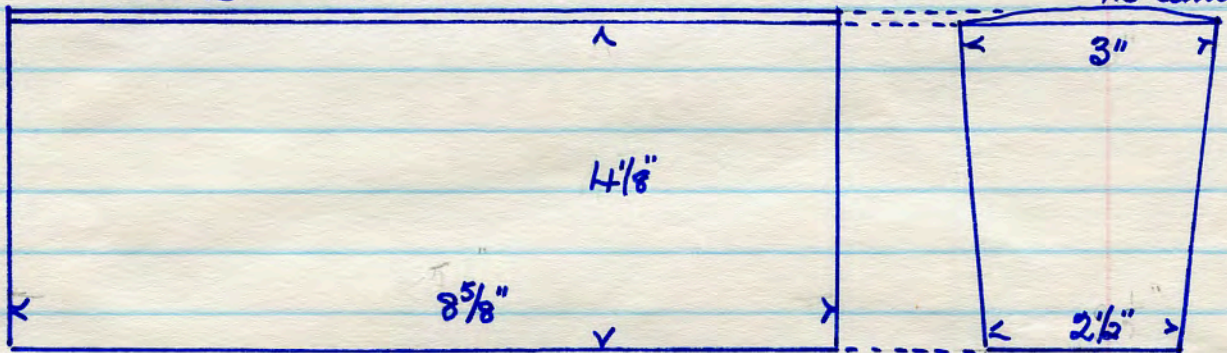

4142

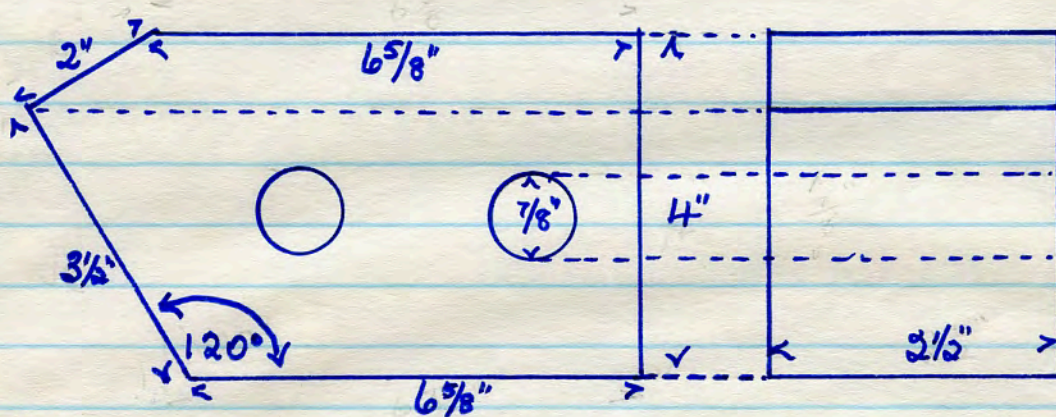

No name
2411L
red T.C.
7 lbs

All edges are rustic finish except one 6 5/8" edge.

4143

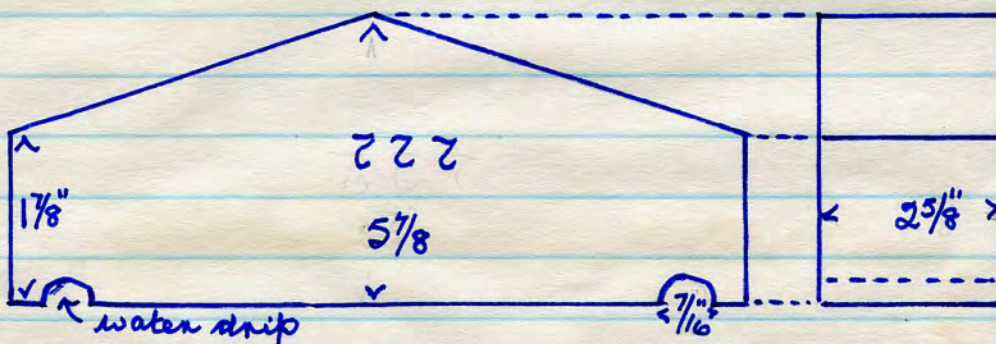

No name
222
red T.C.
12 lbs.

4144

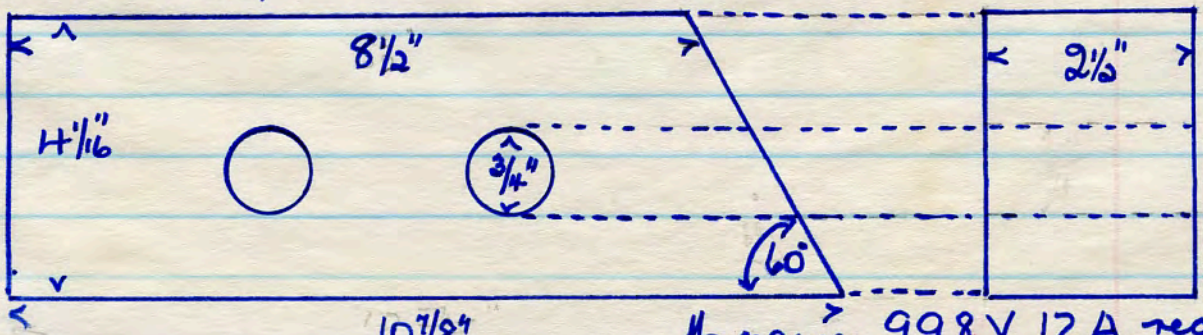

No name 998V 12A. red T.C. 9 lbs

4145

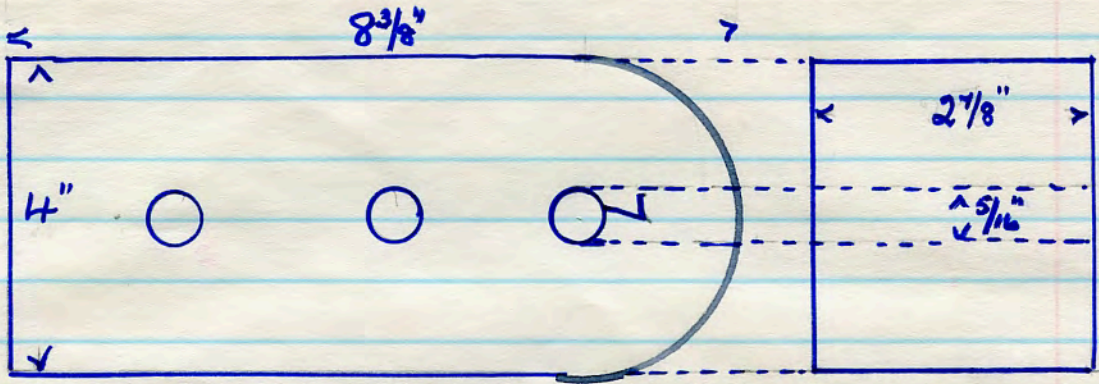

No name 7 red T.C. 9 lbs.

4146

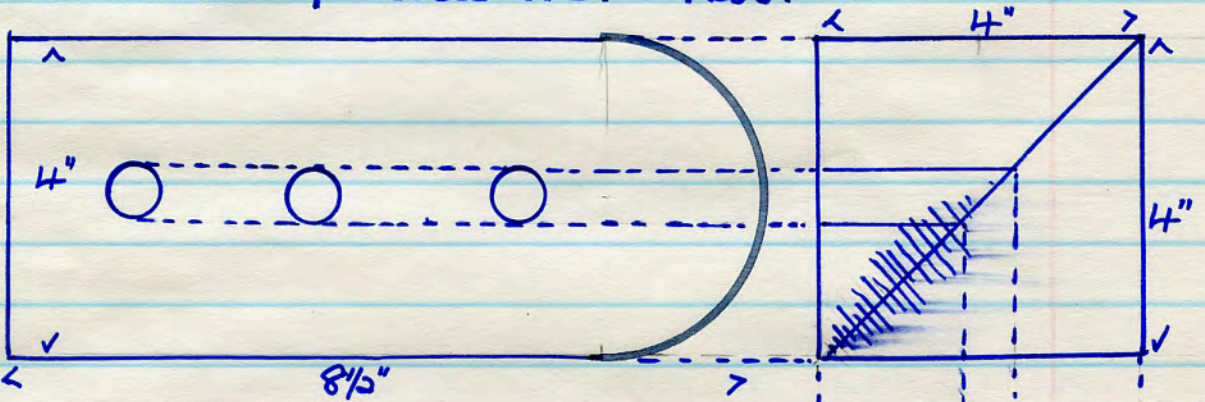

No name 269 TA red T.C.
12 1/2 lbs.

Acfton Mass dem. site 16. 12. '88

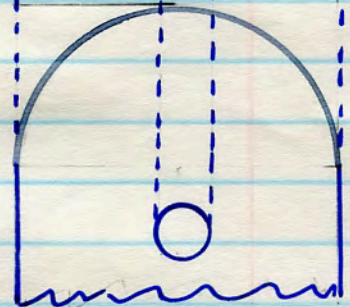

No name 95 VO red T.C. smooth face 6 1/2 lbs.

4147

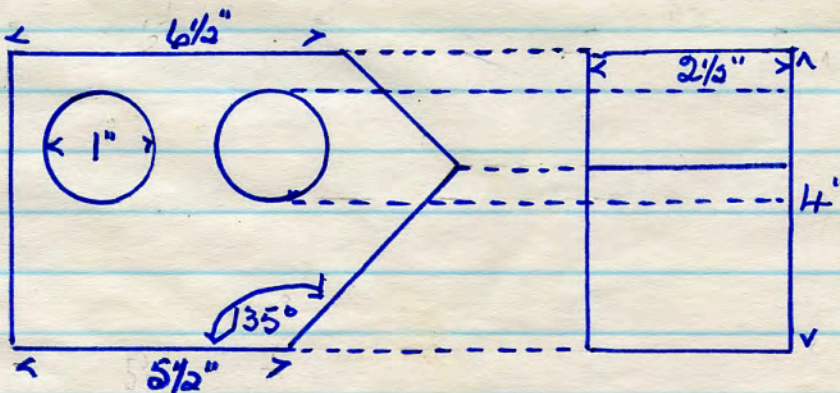
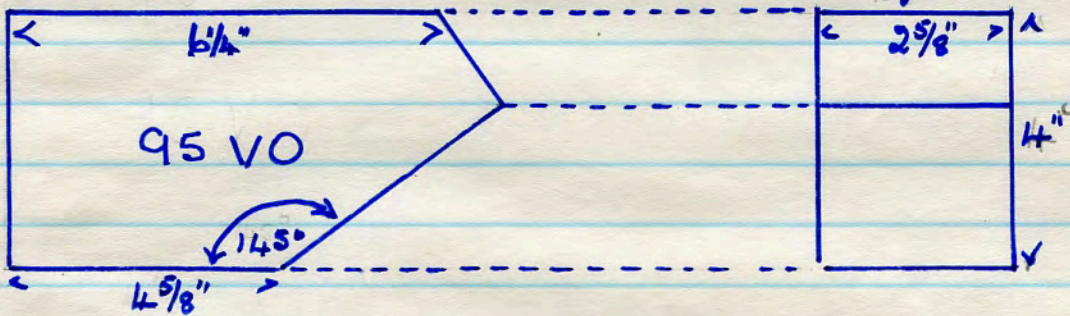

4148

No name
24 12C
dark brown T.C.
smooth finish
7 lbs

Acfton Mass dem. site 19. 12. 88

No name PL 795 red T.C. 7 lbs.

4149

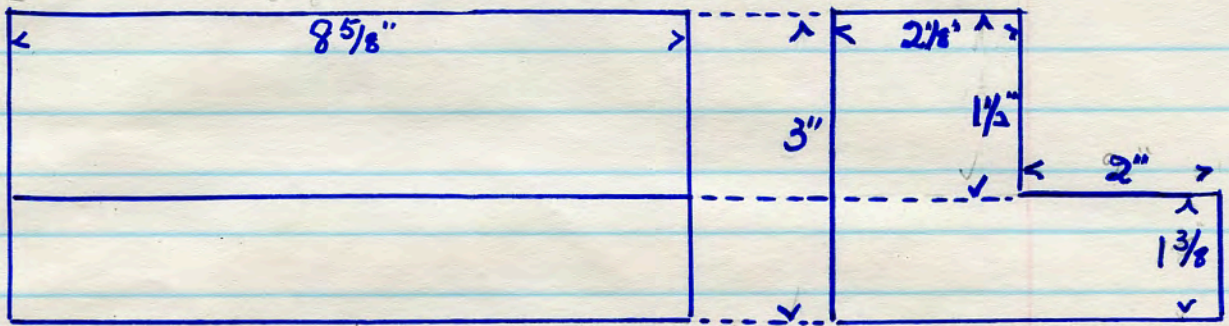

4150

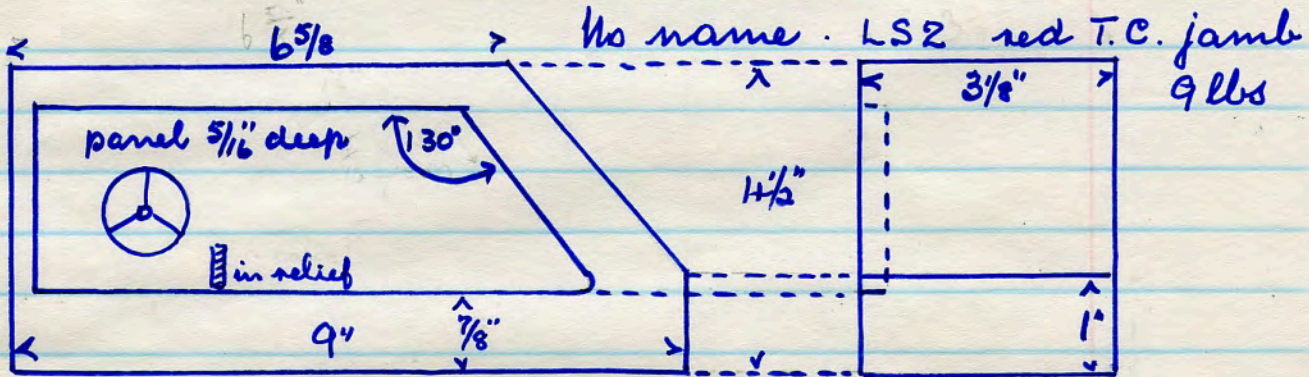

4151

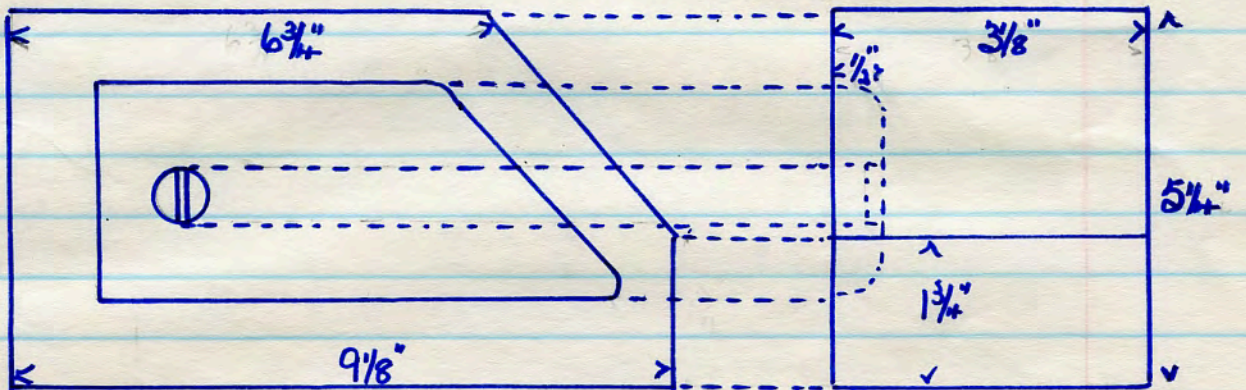

No name LS3 red T.C. jamb. 11 lbs.

4152

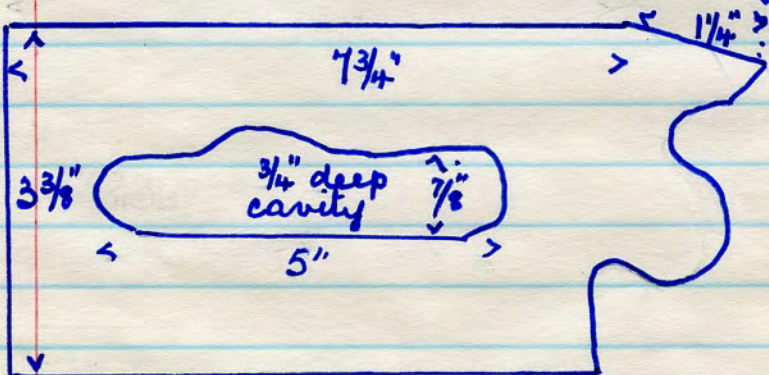

No name 16
red T.C dec. return
9" x 5 7/8"
12 lbs.

Accton Mori dem. Site 19. 12. '88

No name. 258 Z2 red T.C. 6 lbs

H153

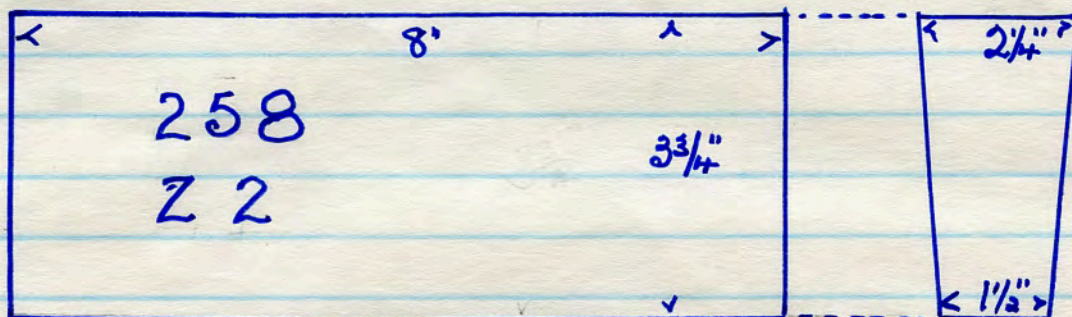

No name 245 1-7 red T.C. 8 lbs.

H154

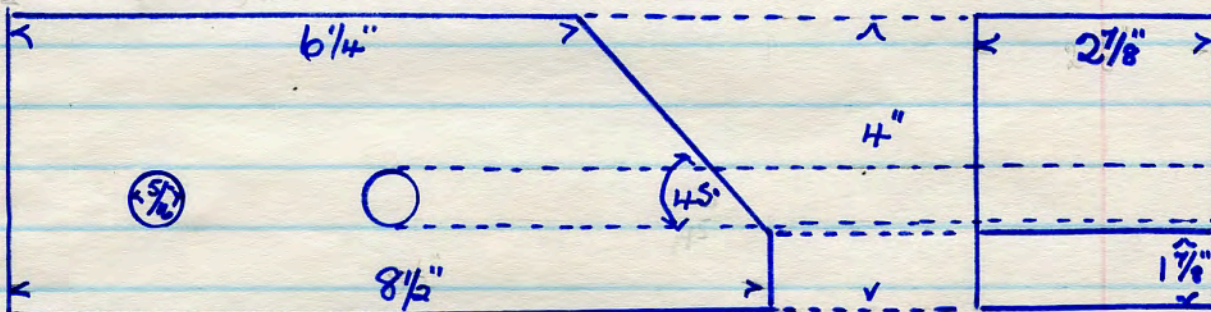

No name 225 T red T.C. 9 lbs.

H155

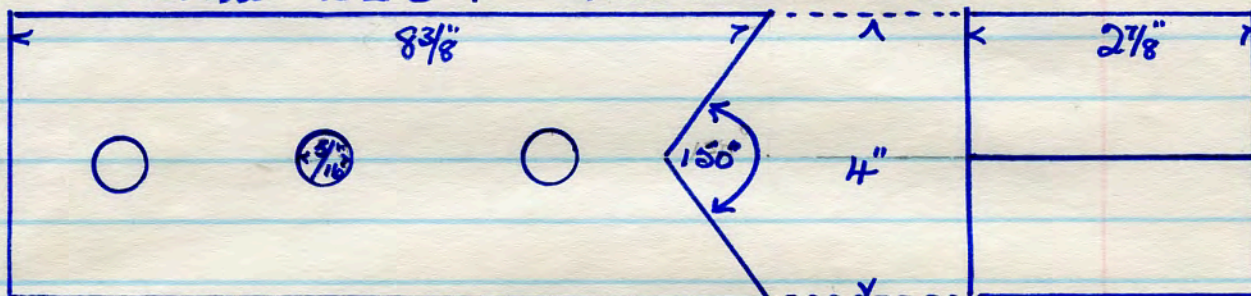

H156

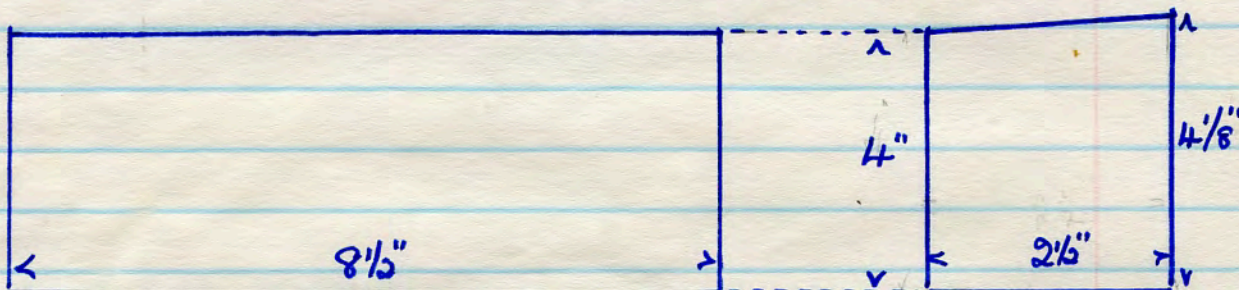

No name AIS red T.C. 7 1/2 lbs.

No name. 251 2LB red T.C. 8 lbs

H157

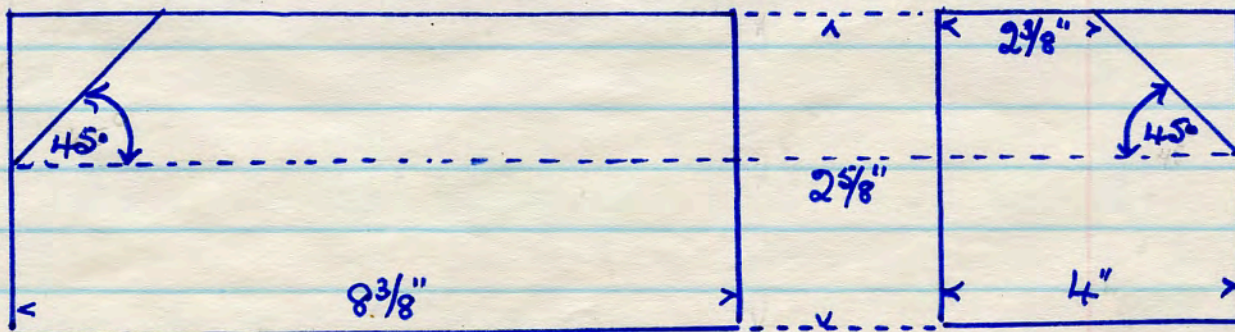

1 face edge + 1 face side - rustic finish
Acclon Moir dem. Site 20. 12. '88

No name 50 R 3 red T.C. 2 1/2 lbs.

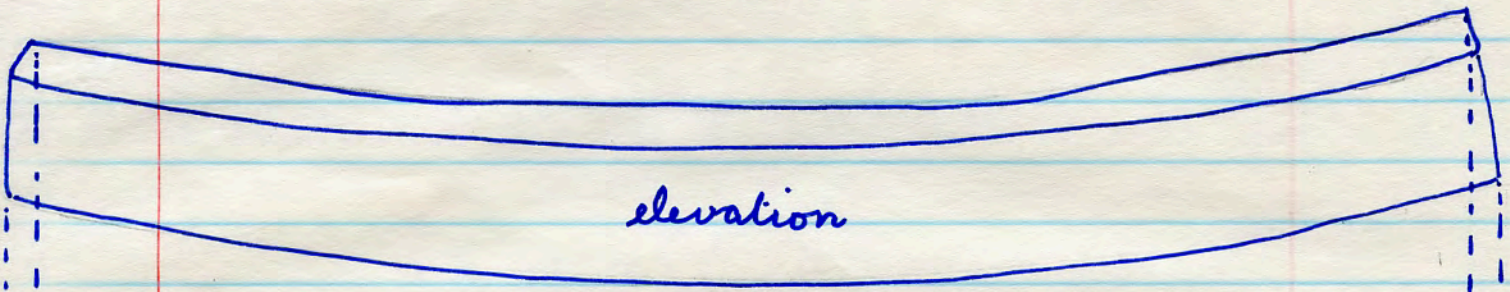

4158.

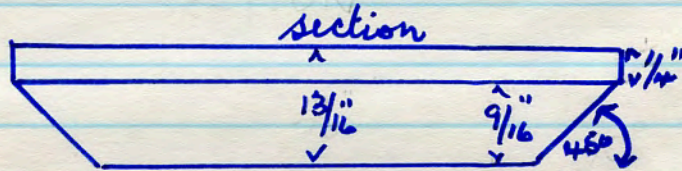

plan

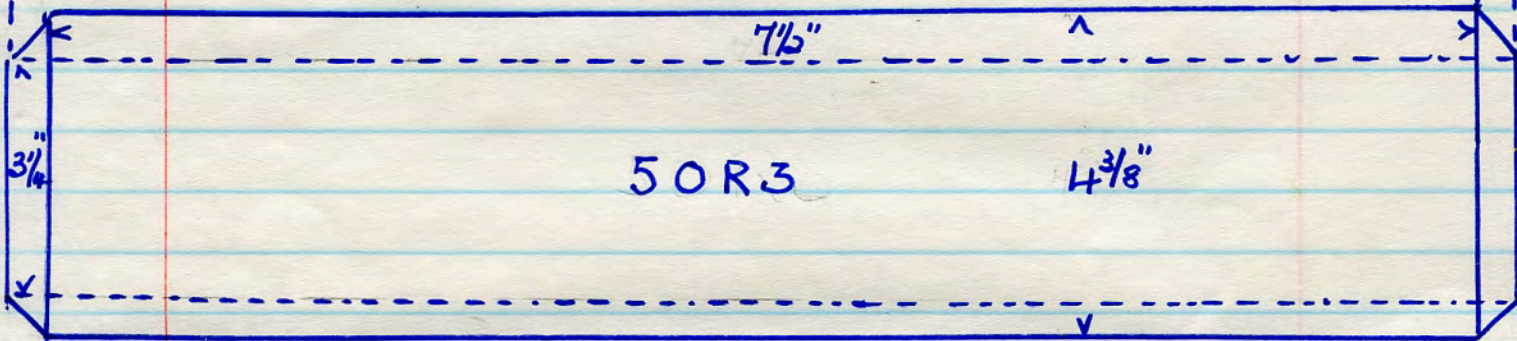

Acpton Mori dem. site 20. 12. 88.

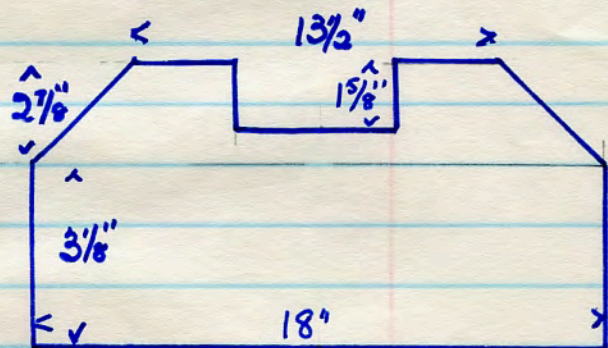
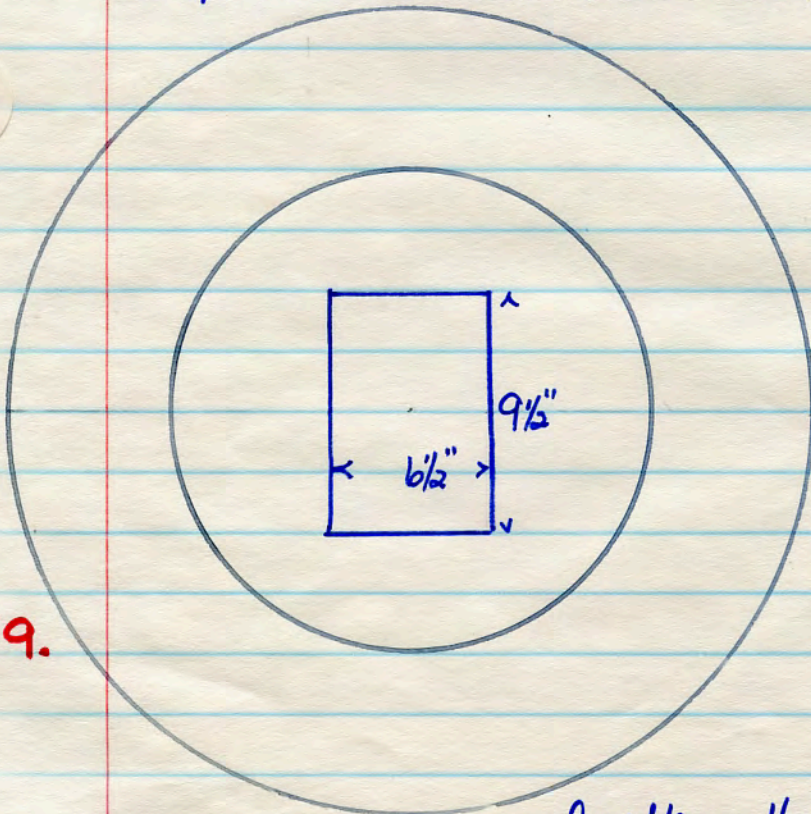

No name,
red T.C.

4159.

Acpton Mori dem. site 22. 12. '88

Acc/ton Mori dem. site 3. 1. '89

4160

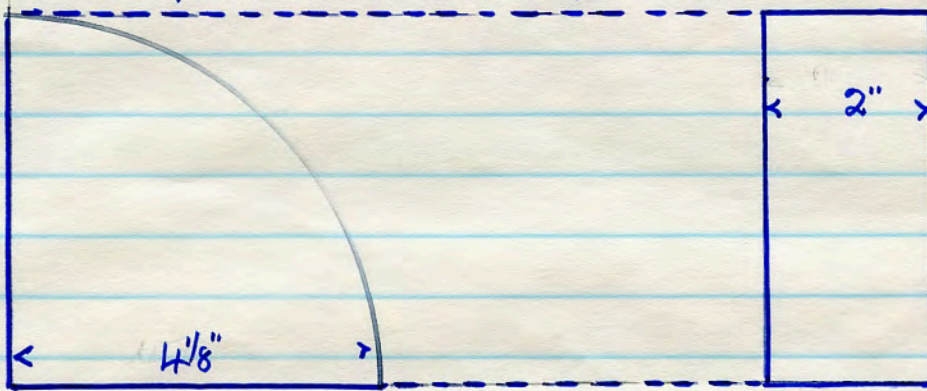

No name

603 U36
red T.C.
2 1/2 lbs

4161

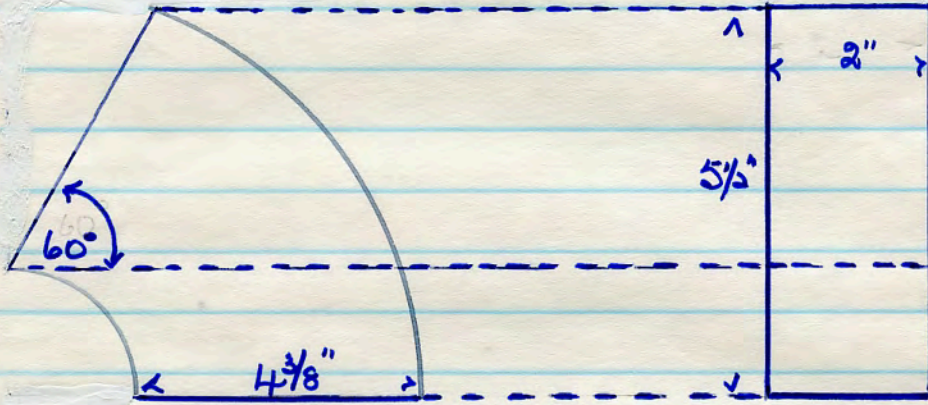

No name

23 Q2
red T.C.
4 lbs.
HT moulder's
marks.

No name. SR 39 red T.C. 16 1/2 lbs. HB moulder's marks
3/16" concave

4162

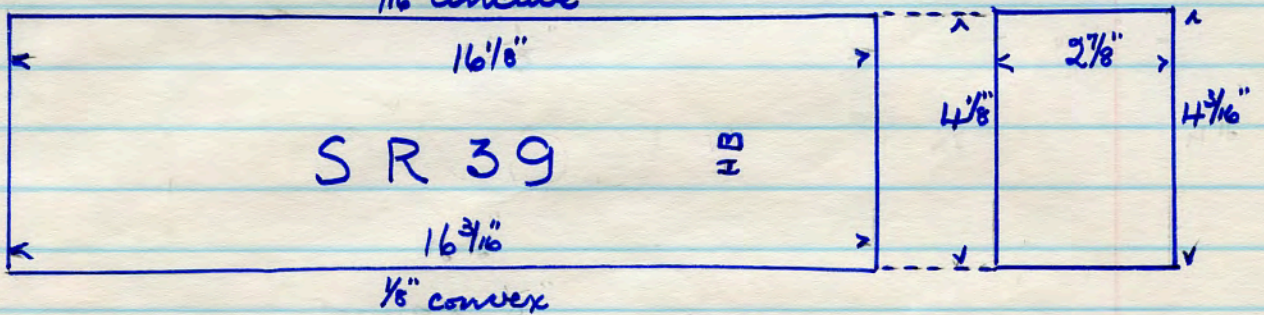

Acc/ton Mori dem. site 4. 1. '89

4163

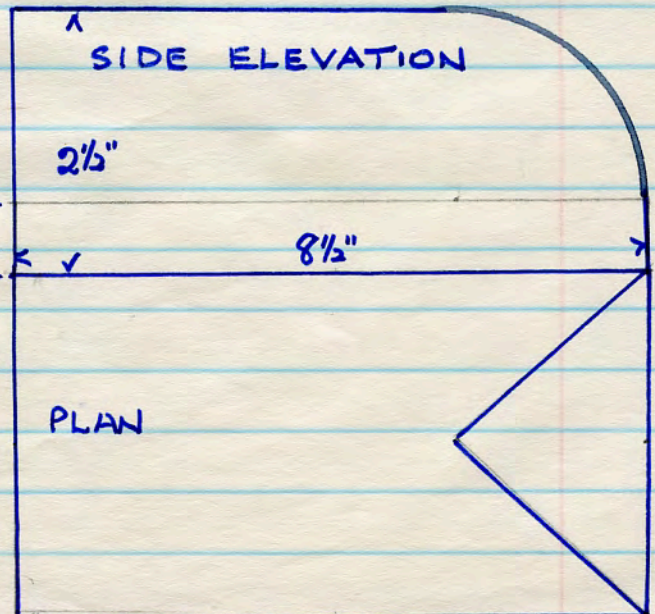
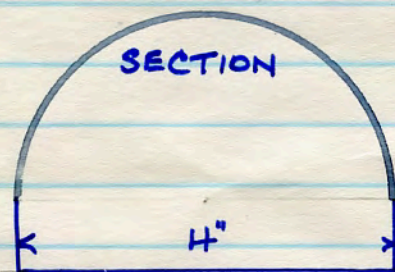

No name 231 428
red T.C. 7 lbs.

4164

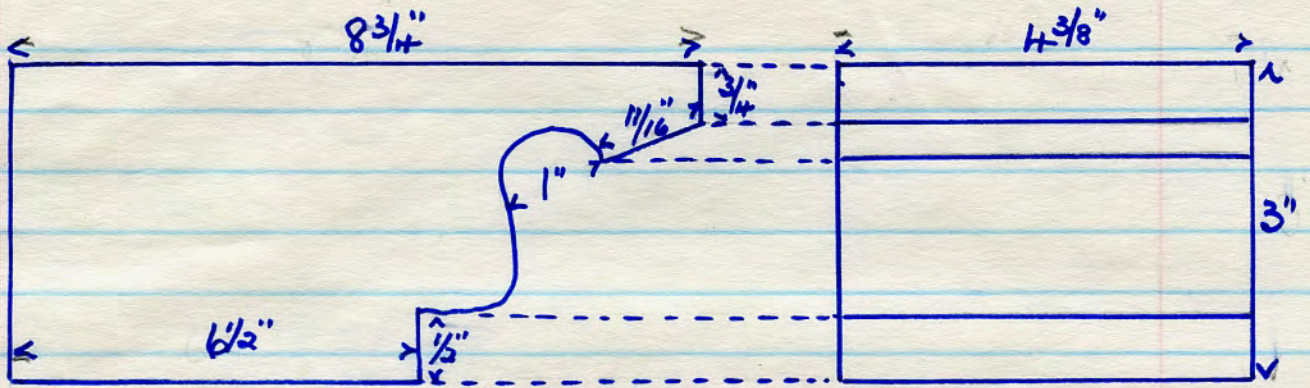

No name 395 V 12 red T.C. dec. header 9 lbs.

4165

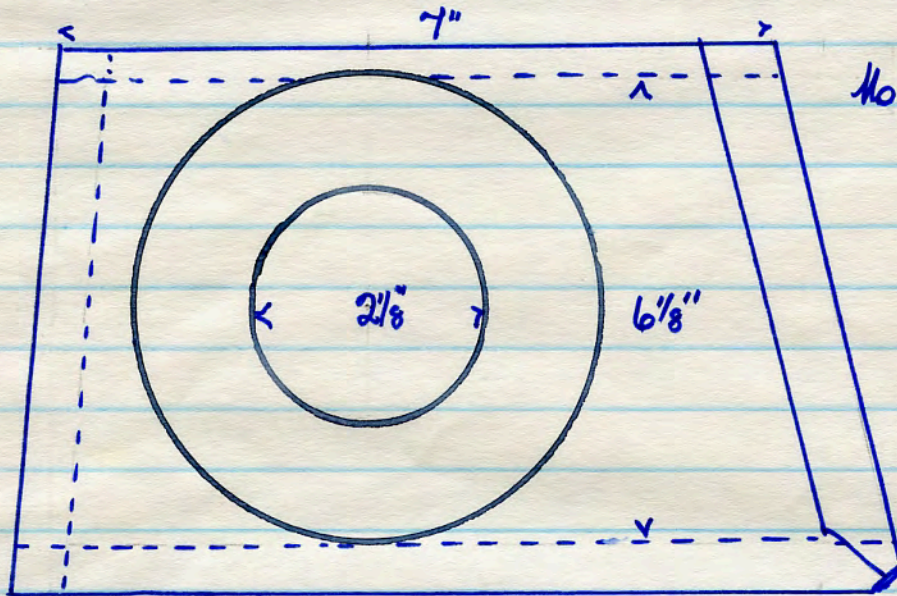

No name
70 N 12 A
red T.C.
22 lbs.

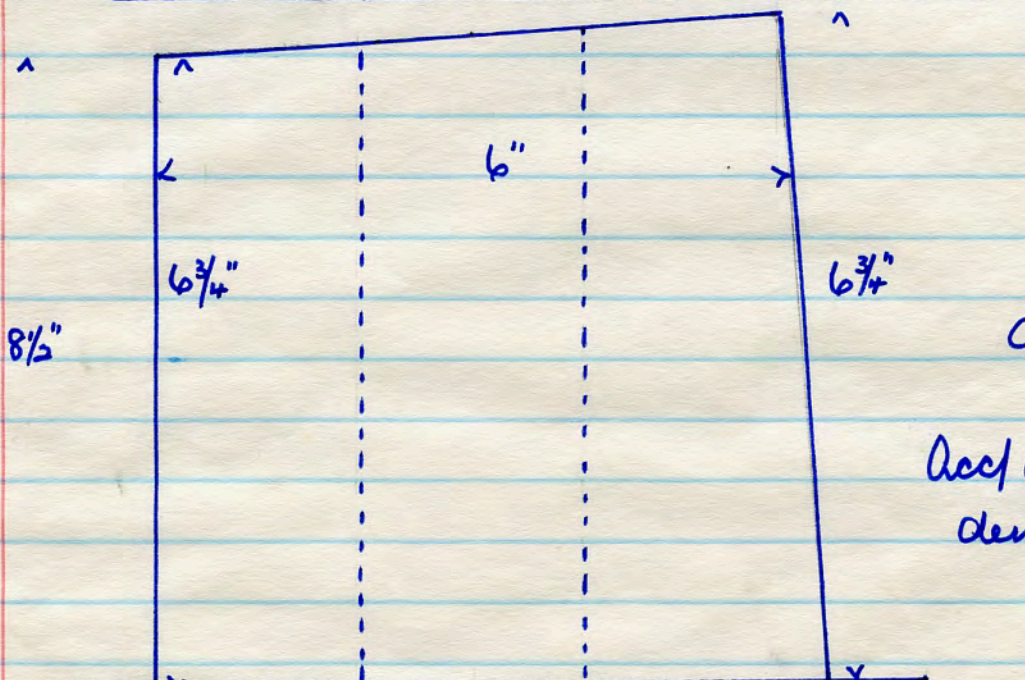

Acc/ton Motri
dem. site
H. I. '89

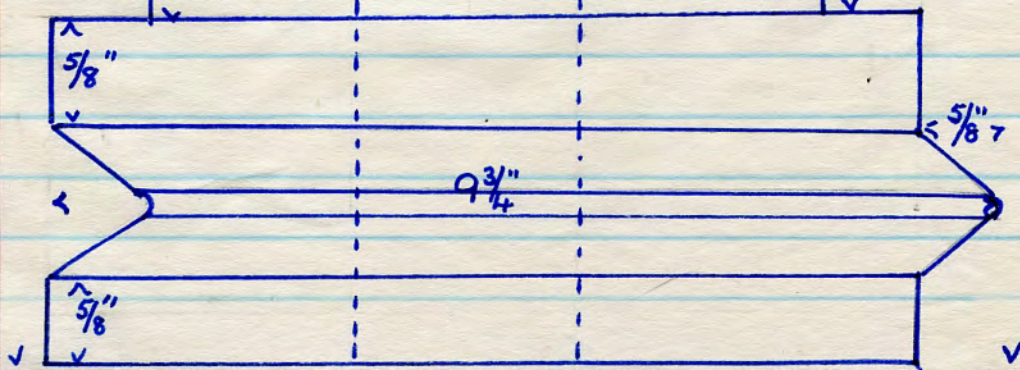

4166

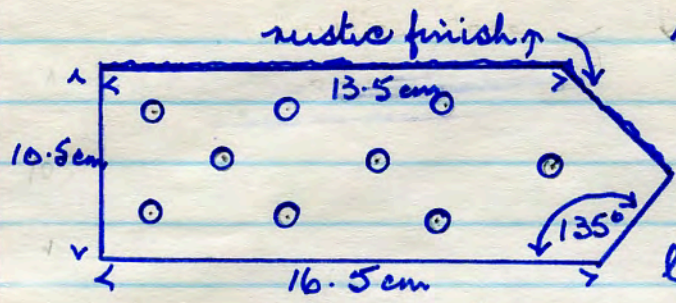

No name
 red squint
 9 perms $\frac{3}{16}$ " diam.
 $6\frac{3}{4}$ lbs.
 letter R on end

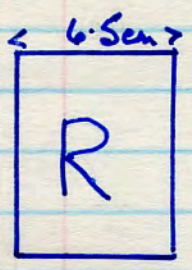

4167

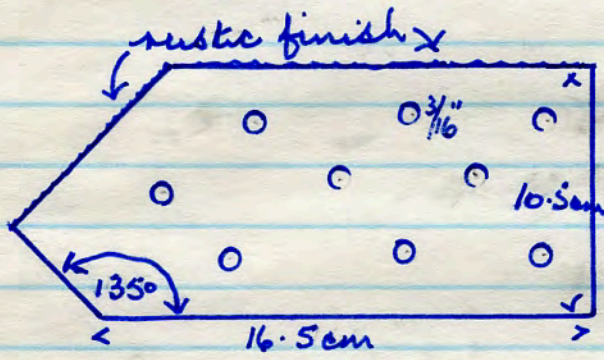

No name.
 red squint
 9 perms $\frac{3}{16}$ " diam.
 $6\frac{3}{4}$ lbs.
 letter L on end

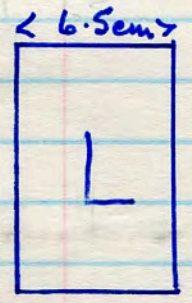

4168

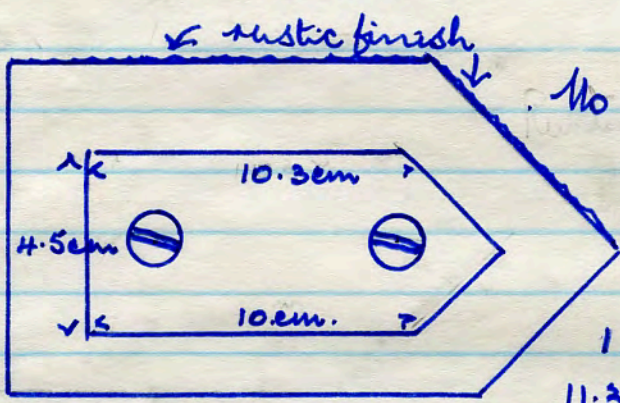

No name R on end
 red squint. 6 lbs.
 This brick is
 pair to No 3795
 1 cavity
 $11.3\text{cm} \times 4.5\text{cm} \times 4.3\text{cm}$ deep.

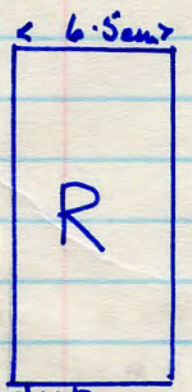

Bepton Mori dem. site 6. 1. '89

No name. 24 23. 10 lbs.

4169

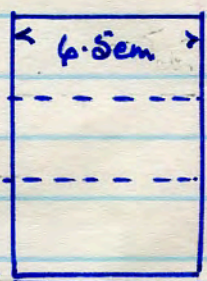
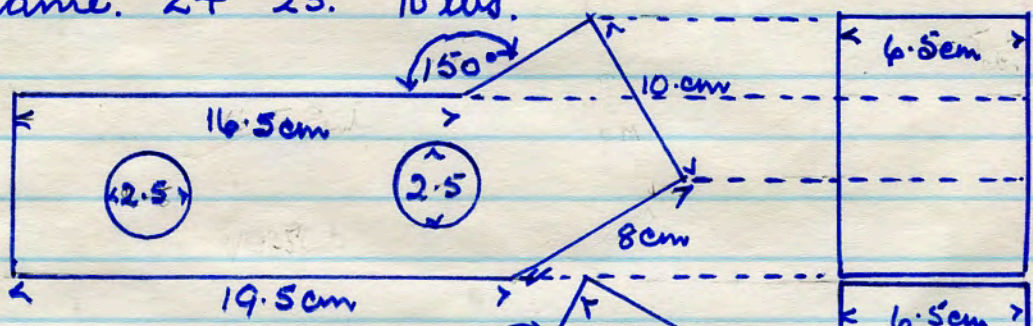

4170

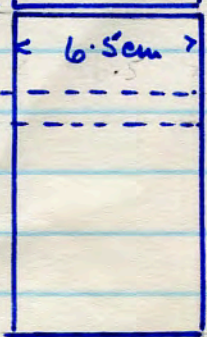
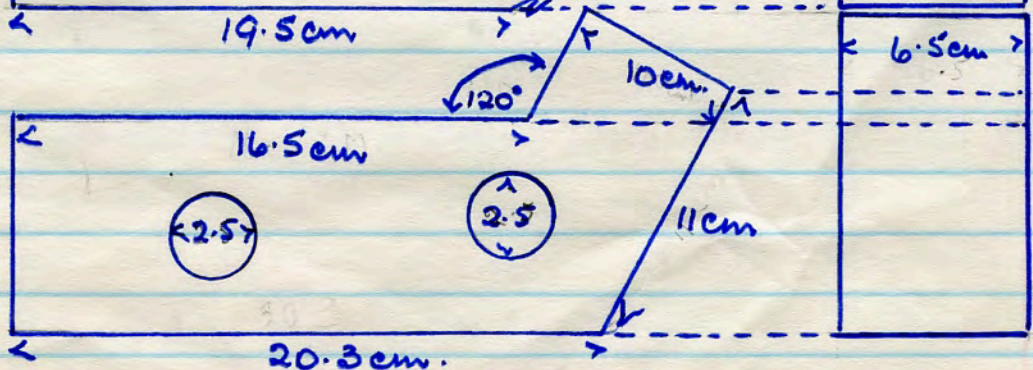

No name. 24 33 11 lbs.
 Bepton Mori dem. site 8. 1. '89

All from section Mori dem. site 7. 1. '89
 No name. PL 21 red T.C. 28 lbs. length $9\frac{3}{4}$ "

H171

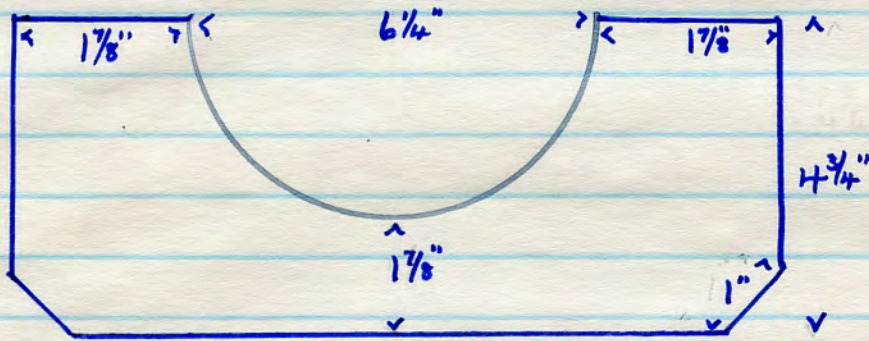

No name. 455 red T.C. 10 lbs

H172

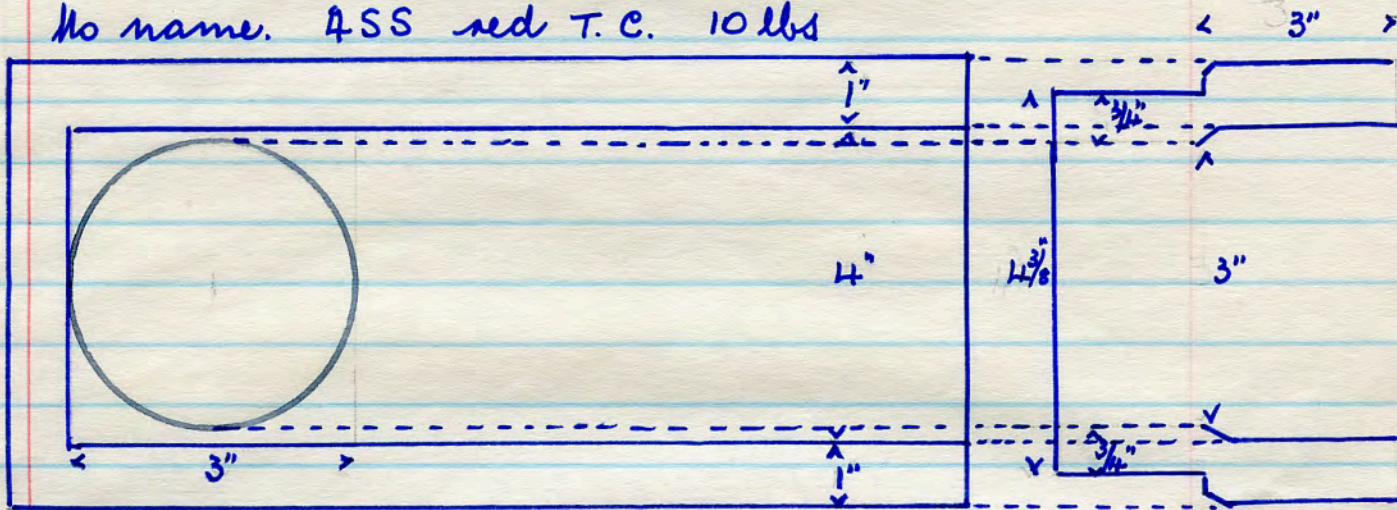

No name 34 red T.C. 10 lbs. dec. header.

H173

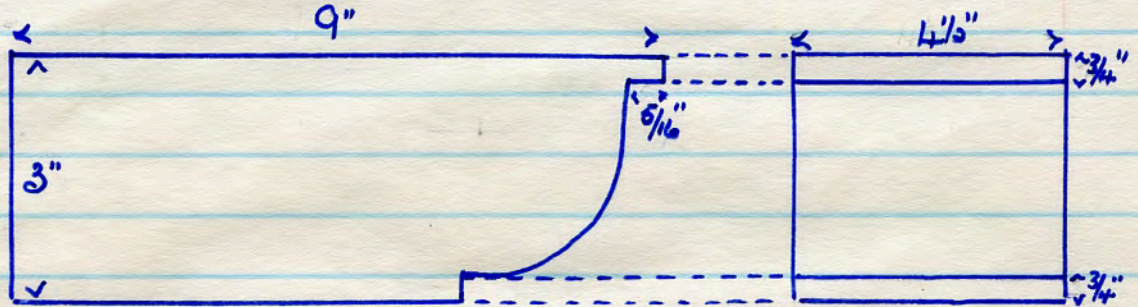

H174

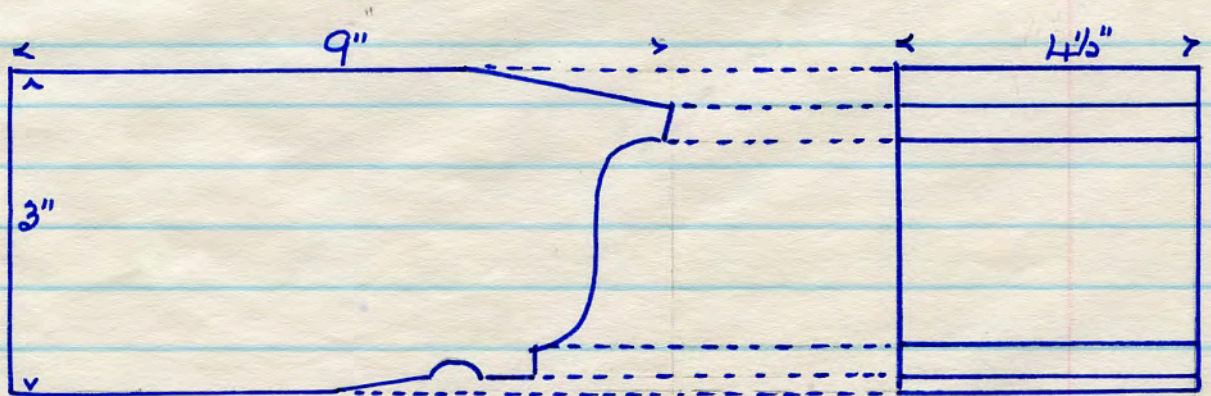

No name. 70 red T.C. dec. header 10 lbs

H175

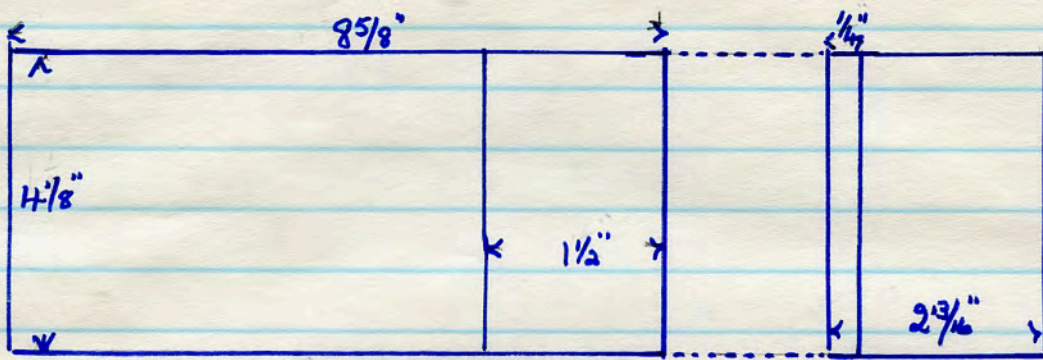

No name
66 U2
red T.C.
9 1/2 lbs.

H176

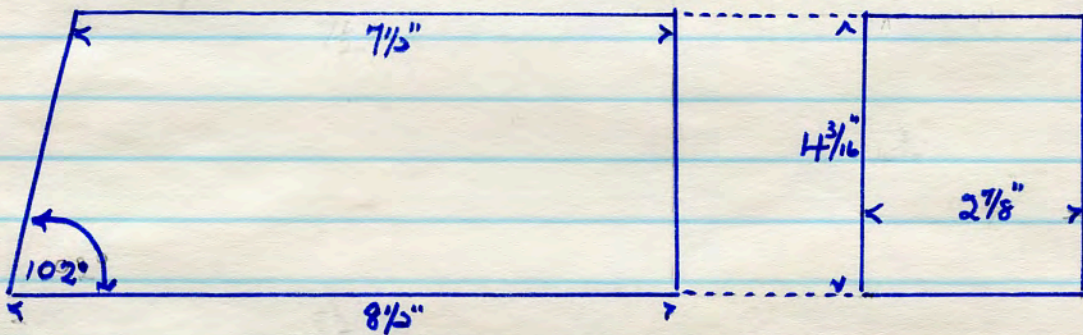

No name
35 J 29
red T.C.
9 lbs

H177

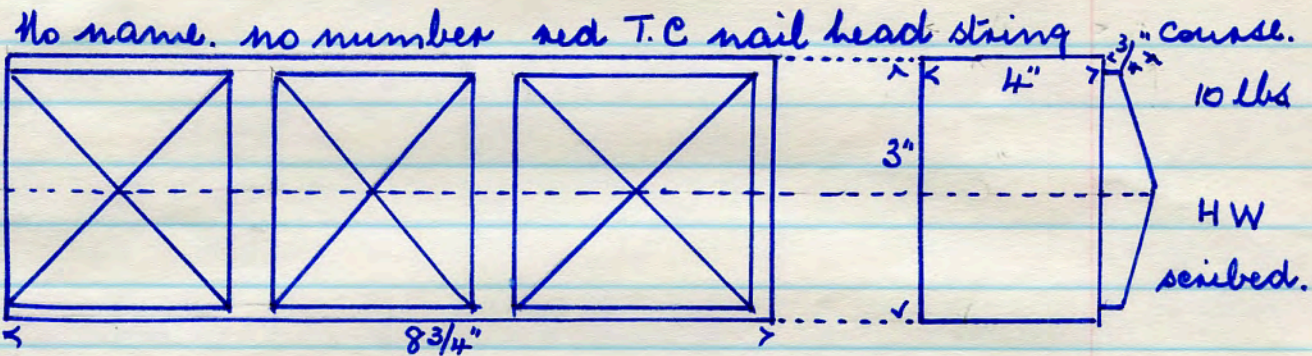

No name. no number red T.C nail head string

3 3/4" course.
10 lbs
HW
scribed.

H178

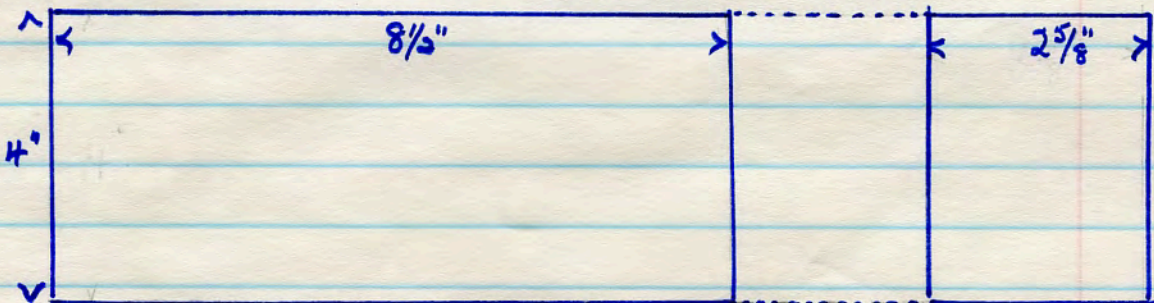

No name. 921 VE. red T.C. 9 lbs.

H179

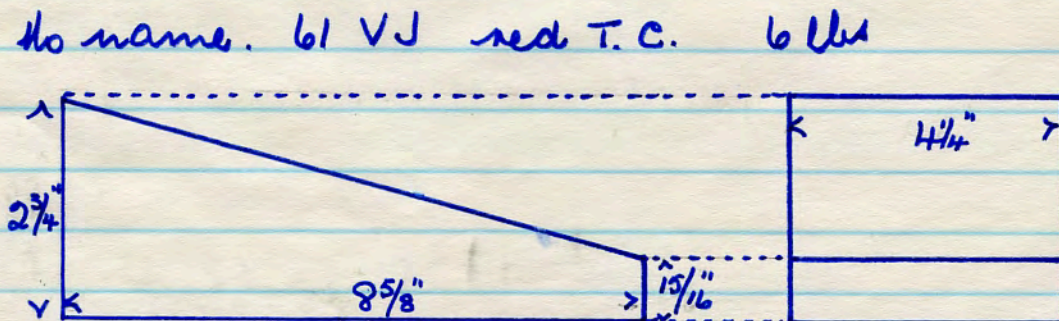

No name. 61 VJ red T.C. 6 lbs

Acceptor Mari dem. site 8. 1. '89

4180

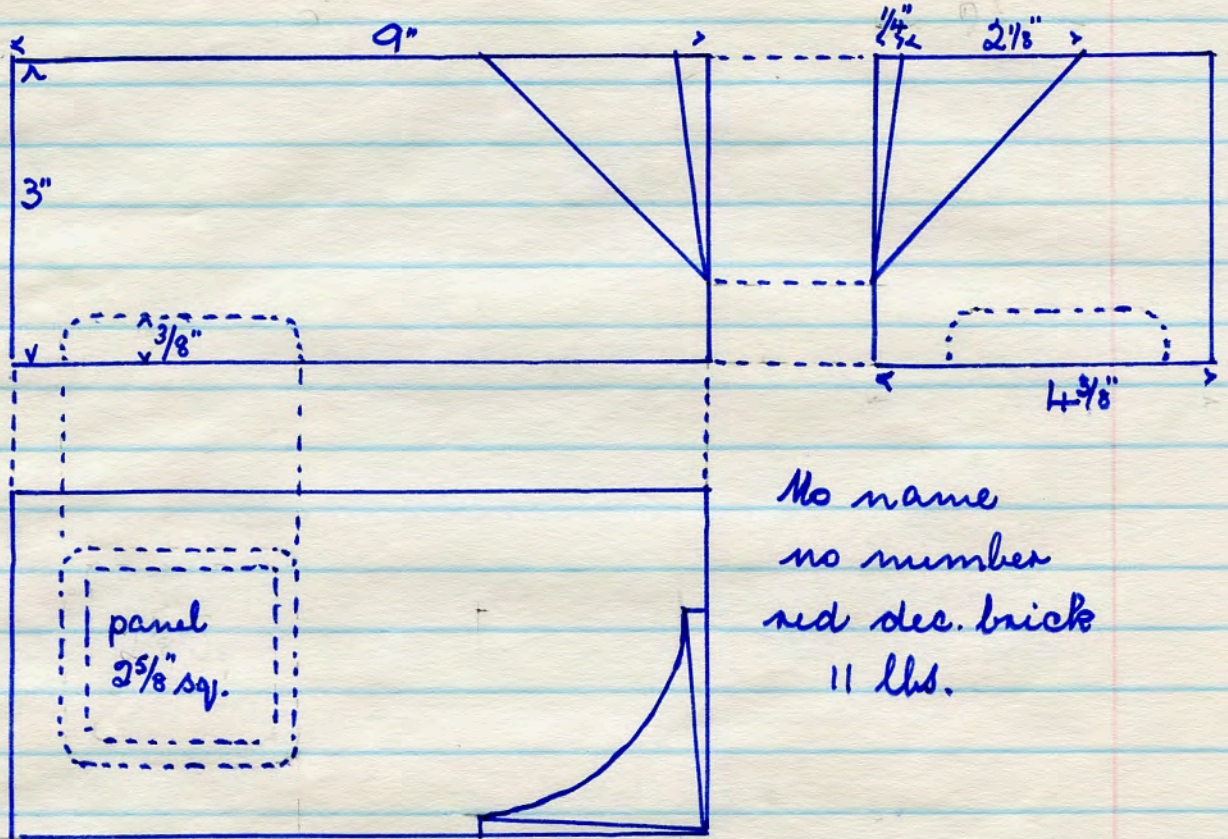

No name
 no number
 red dec. brick
 11 lbs.

4181

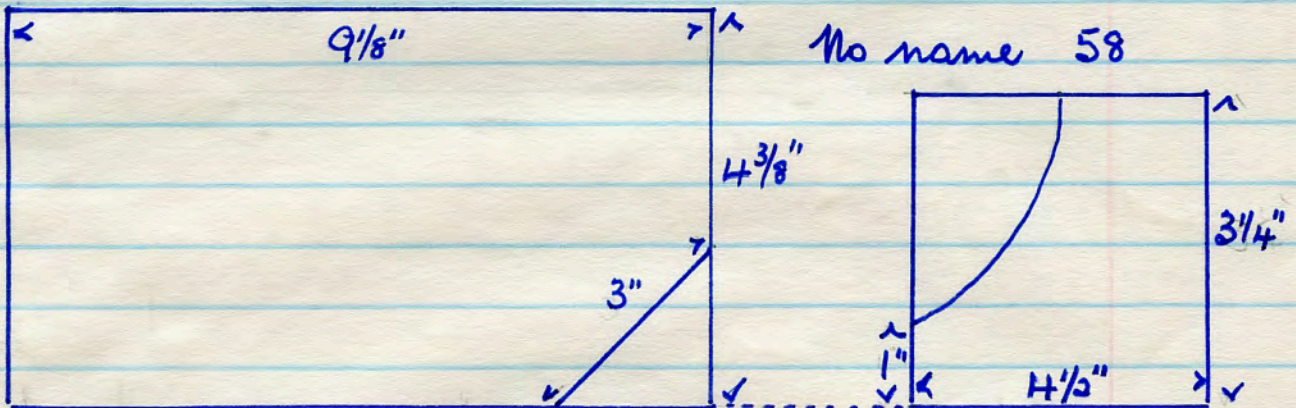

red dec. brick 11 lbs

4182

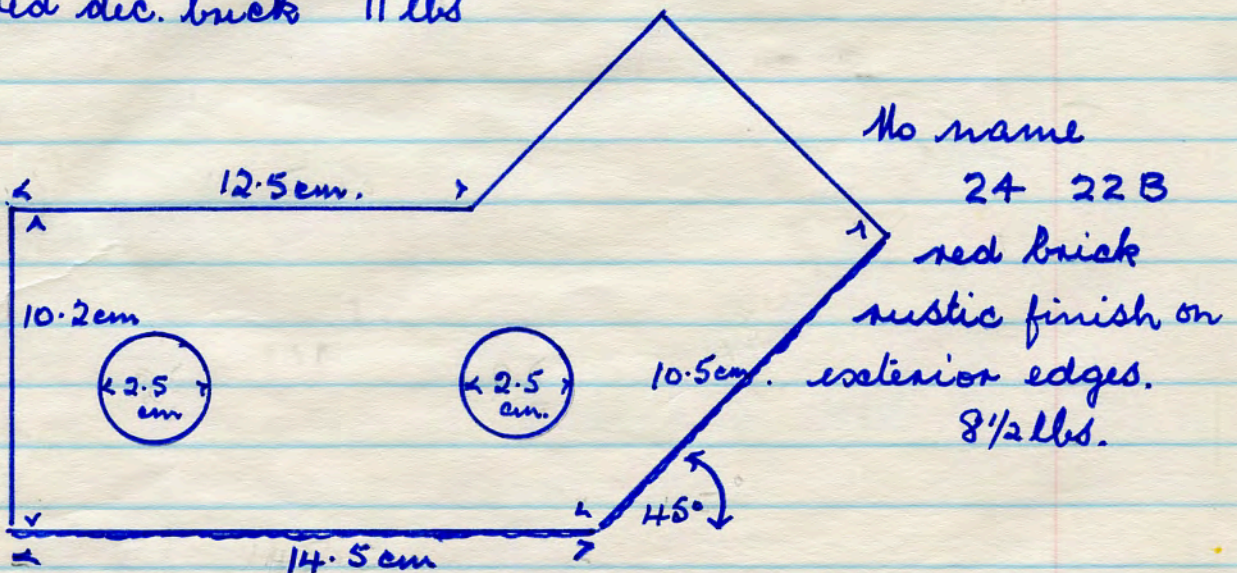

Acpton Mori dem. site 8. 1. 89.

4183

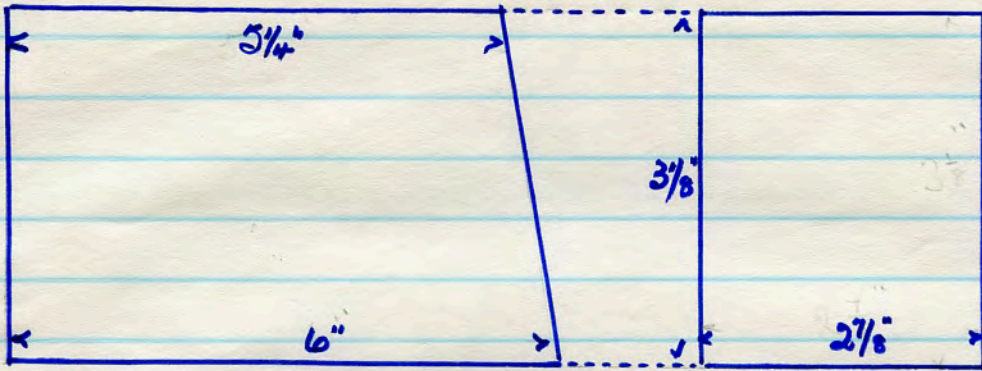

No name
71 N
red T.C.
7 lbs

4184

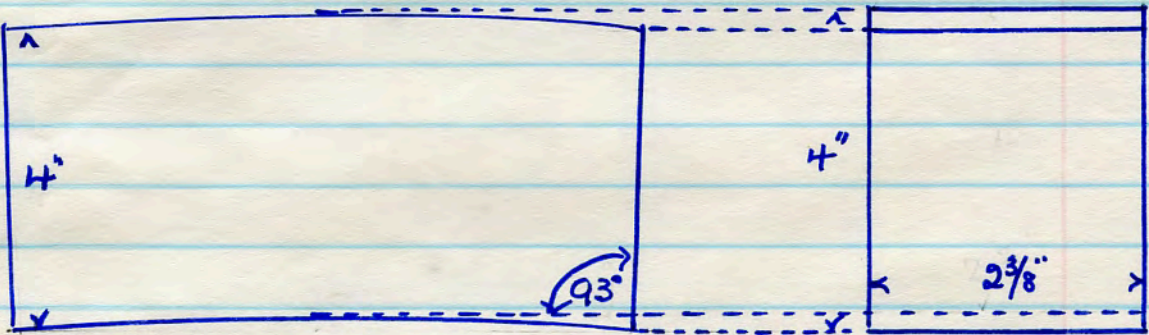

96 P1
red T.C.
8 lbs

4185

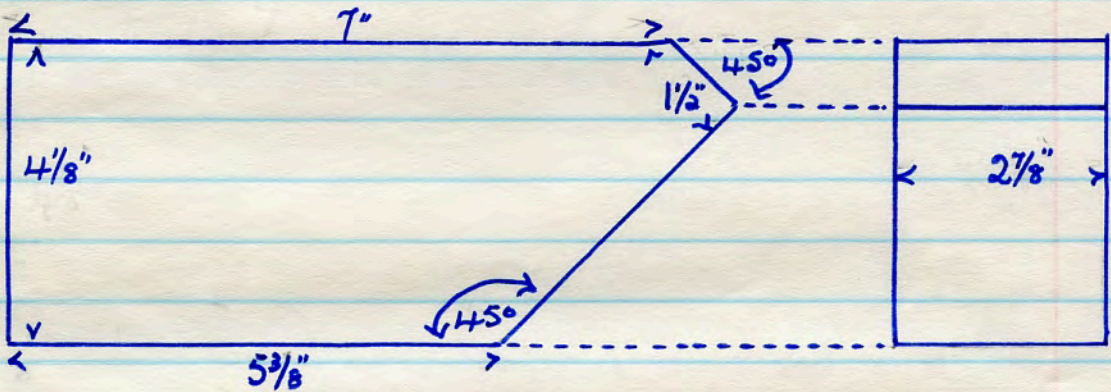

467 VT
red T.C.
8 lbs.

4186

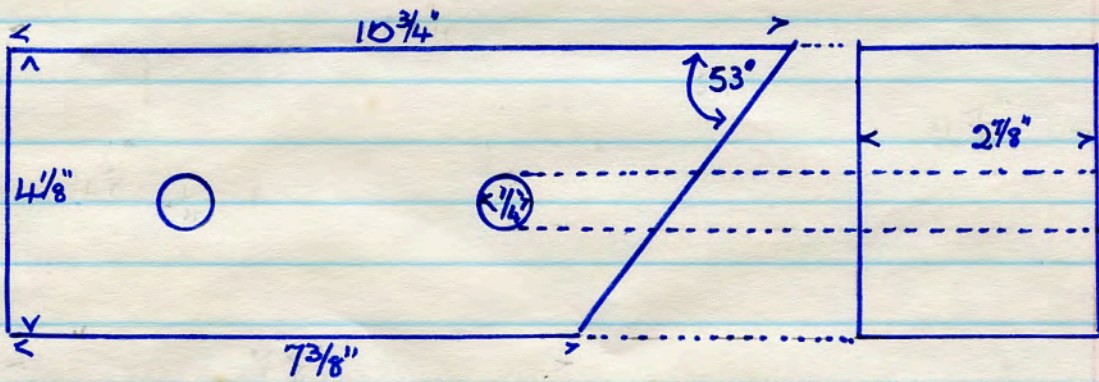

91 F 92
red T.C.
10 1/2 lbs

4187

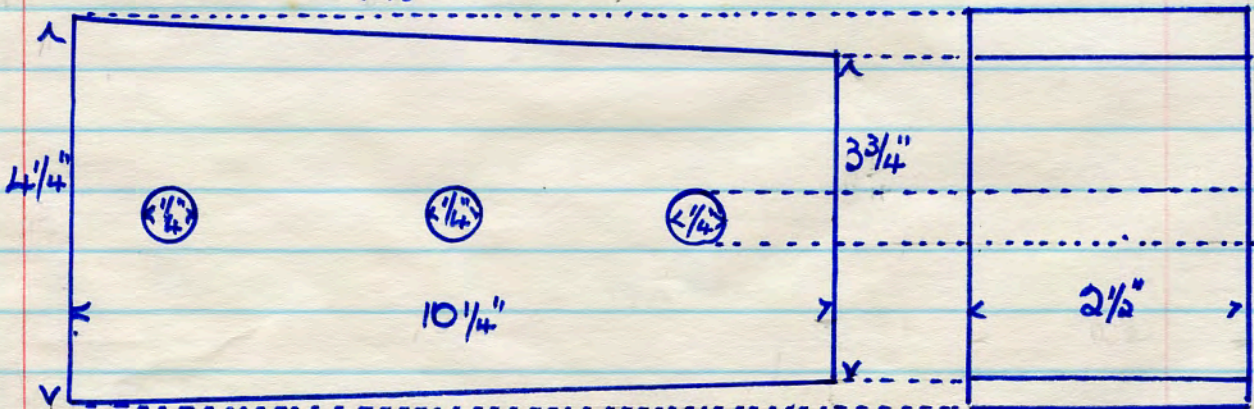

1 X
red T.C.
9 1/2 lbs

All from Accpton Mari dem. site 9. 1. '89

4188

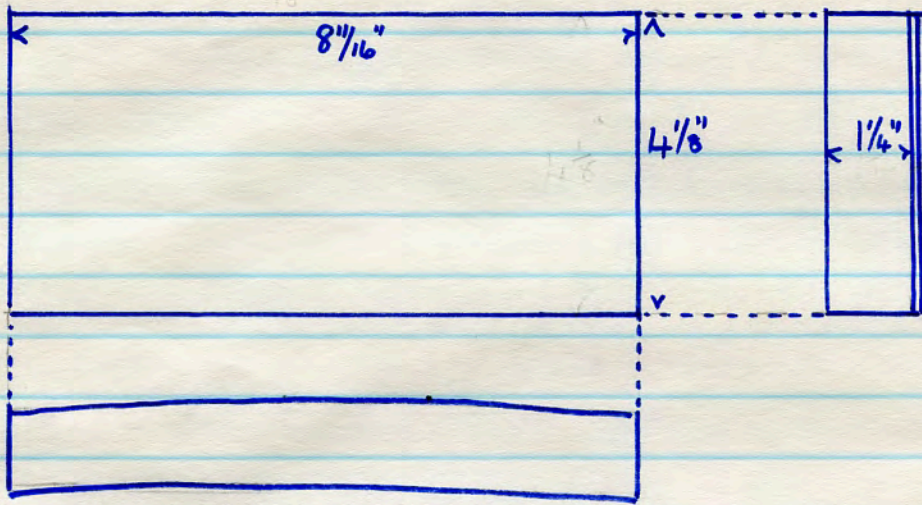

No name
 57 E 104
 red T.C.
 5 1/2 lbs

4189

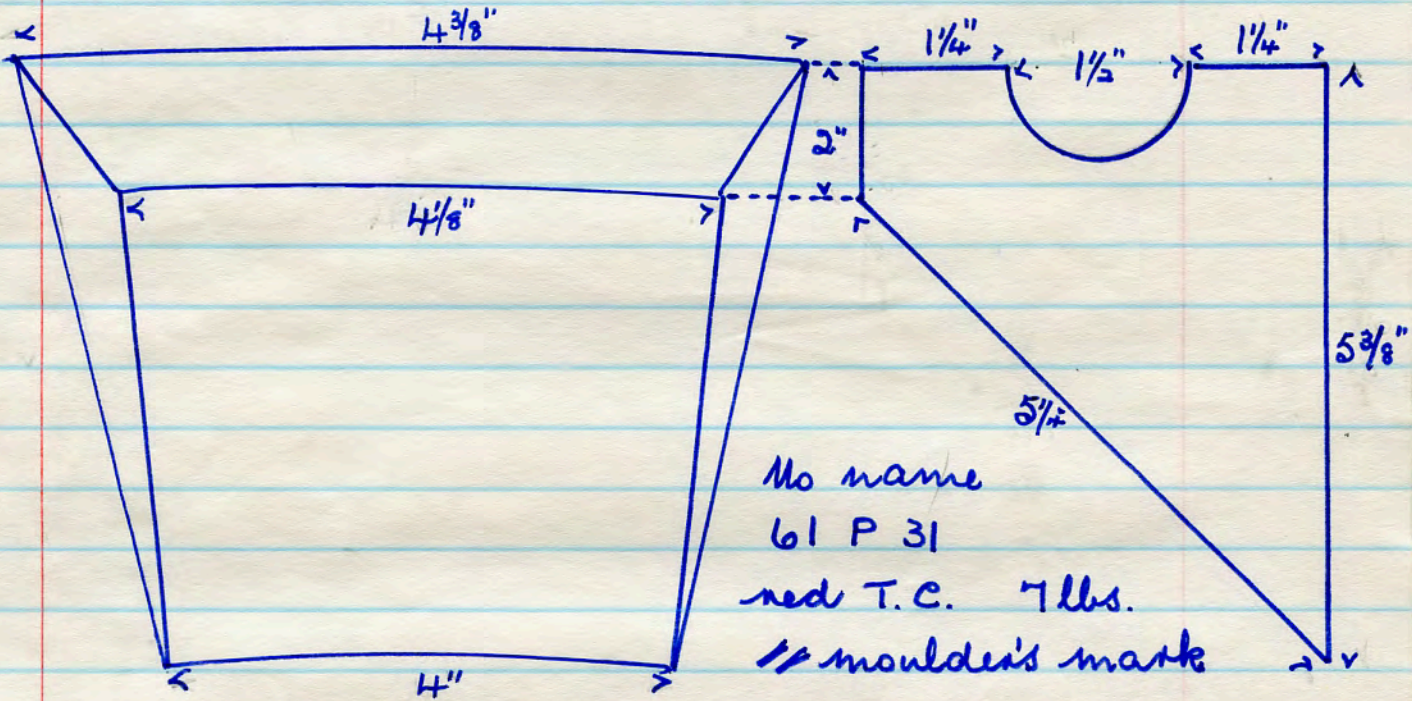

No name
 61 P 31
 red T.C. 7 lbs.
 // moulder's mark

Acfton Mori dem. site. 9. 1. '89

4190

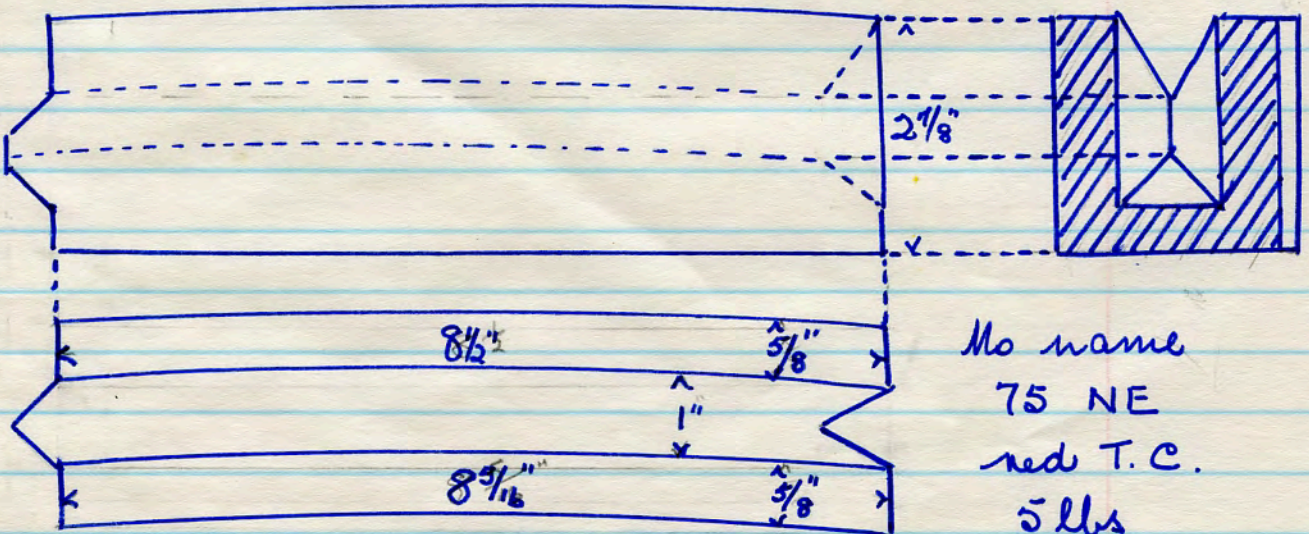

No name
 75 NE
 red T.C.
 5 lbs

Acfton Mori dem. site 10. 1. '89

No name. 98 H 14 red T.C. 3 lbs.

4191

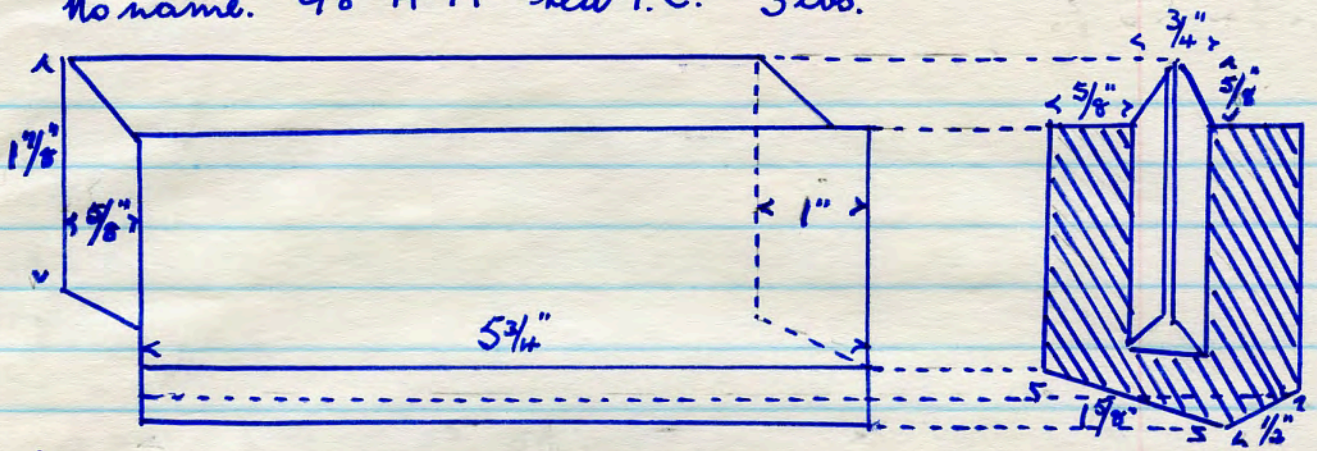

No name. 91 V Z red T.C. 7 lbs

4192



No name. 91 F 95 red T.C. 8 lbs

4193

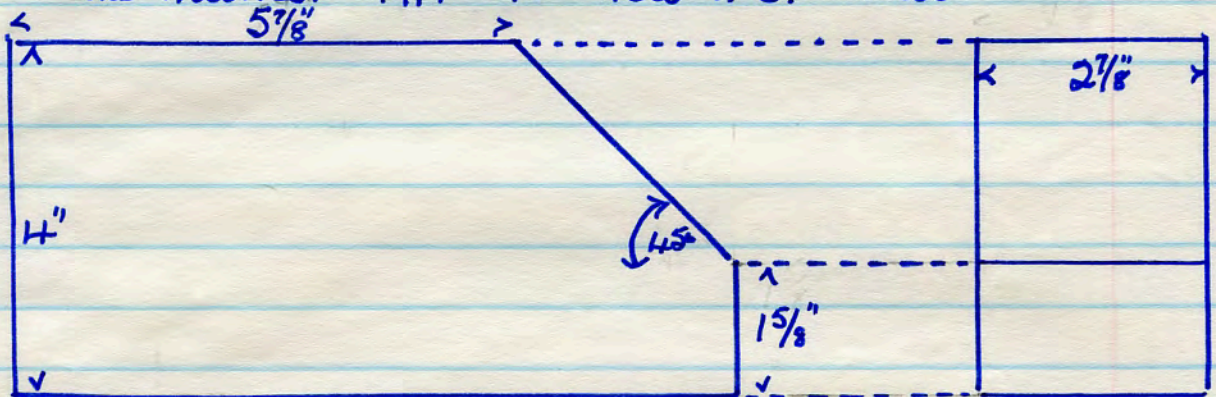

No name. 91 F 545 red T.C. 8 lbs.

4194

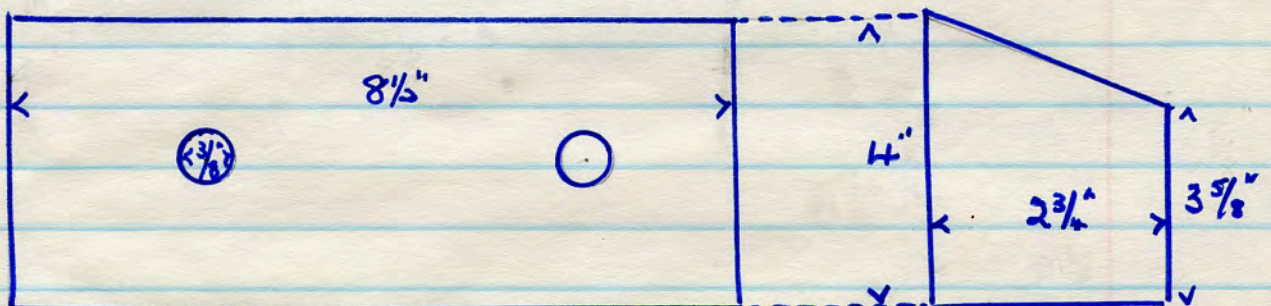

4195

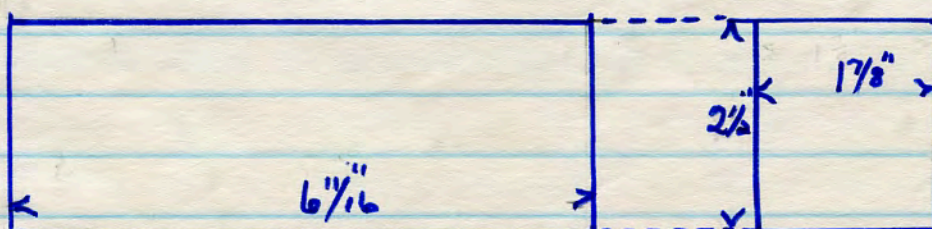

No name
151 V X
red T.C.
3 1/2 lbs.

No name. red rustic brick M452 B. 8 lbs

4196

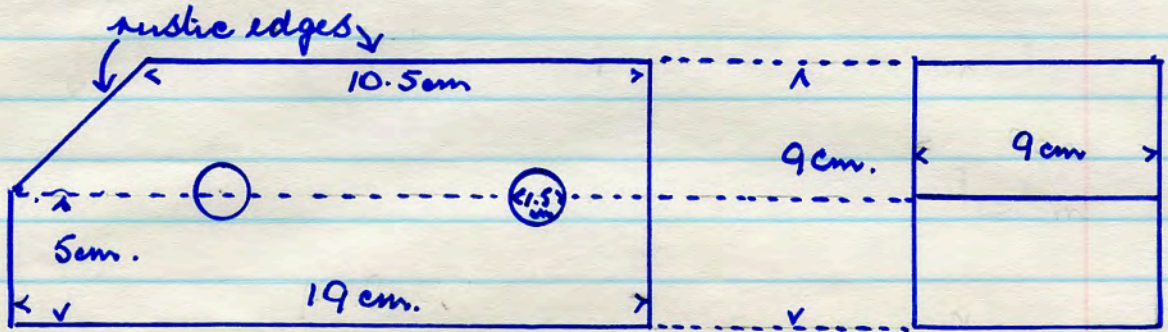

No name 91 F 549 red T.C. 6 lbs.

4197

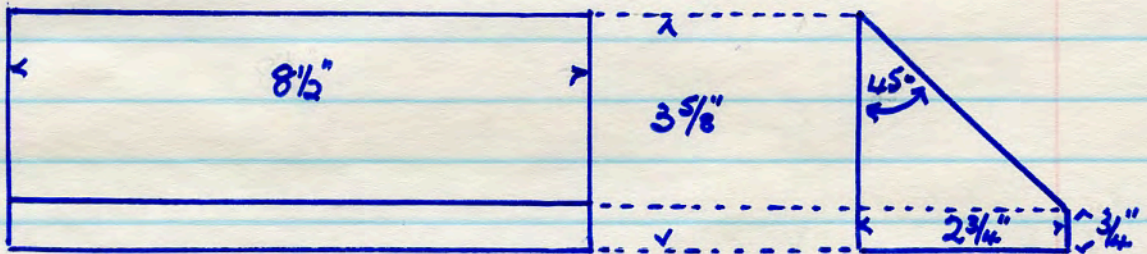

No name 91 F 546 red T.C. 4 lbs.

4198

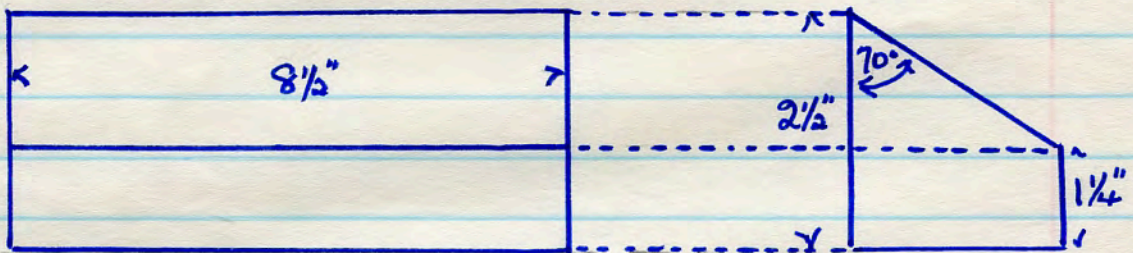

4199

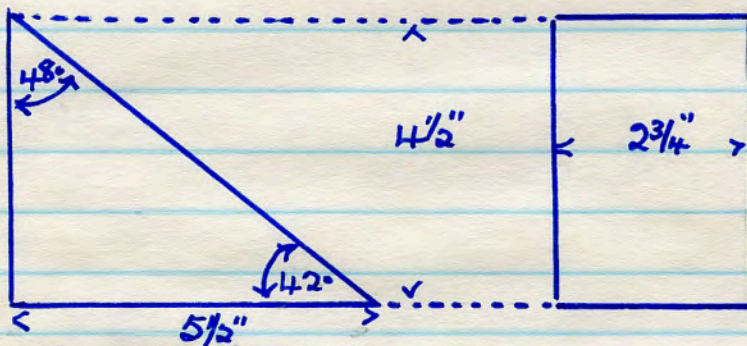

No name
91 F 94
red T.C.
4 lbs.

4200

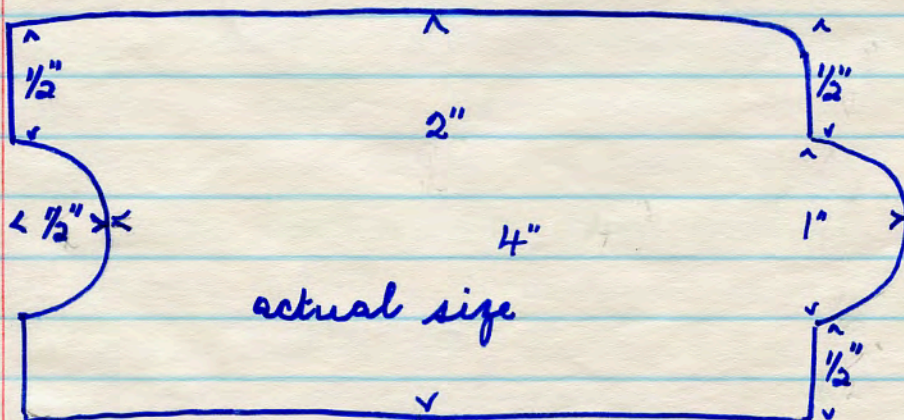

No name
77 L 16
red T.C.
4 lbs.
2" thickness
4" in length

Oxfordton Mori dem. site 10. 1. '89

4201

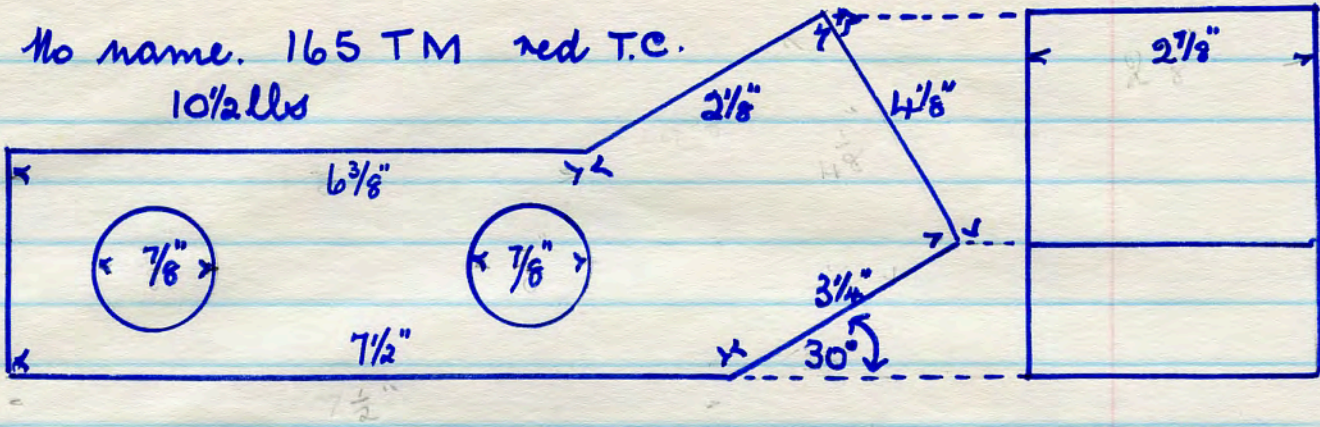

4202

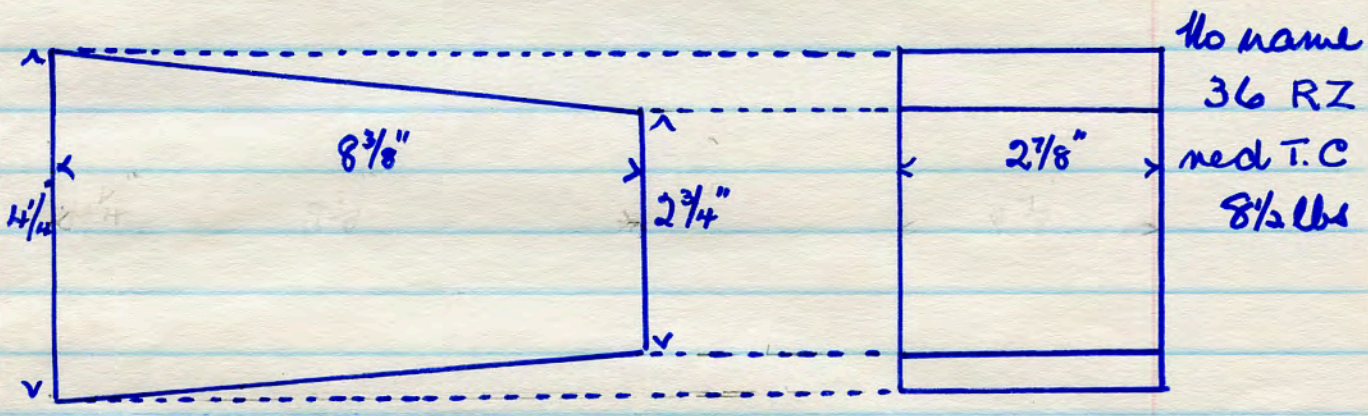

4203

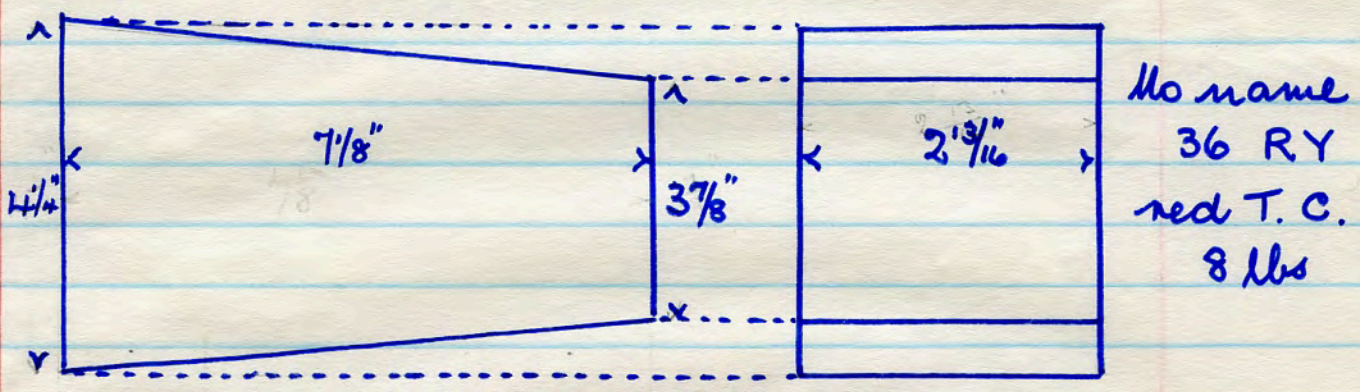

4204

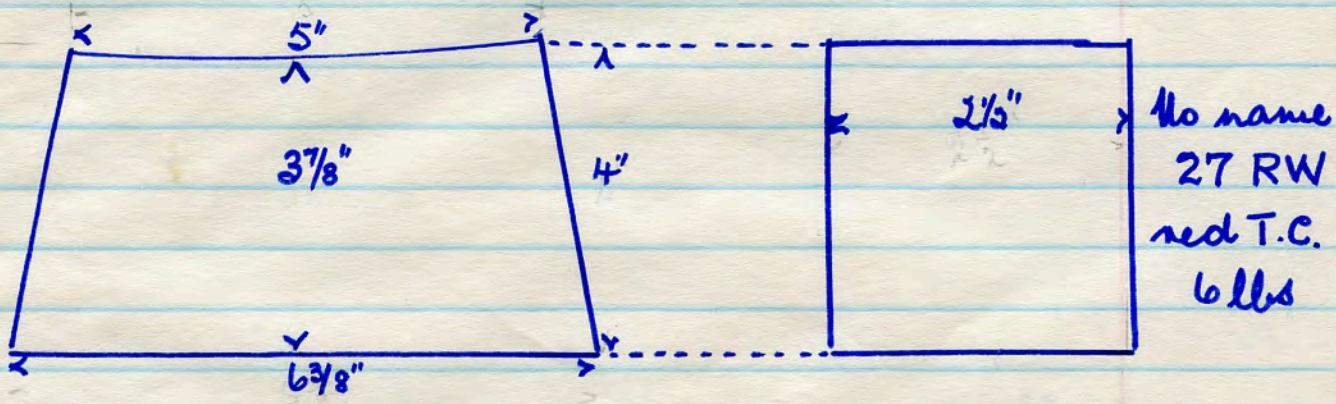

4205

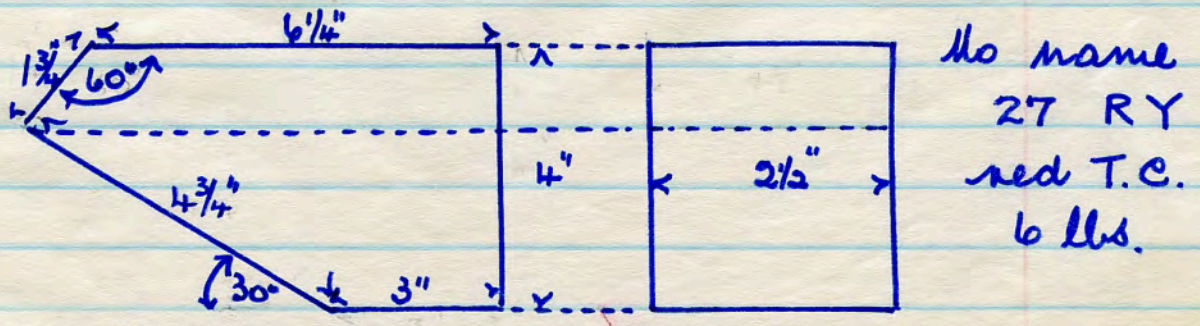

Acpton Mass dem. site 13. 1. '89

4206

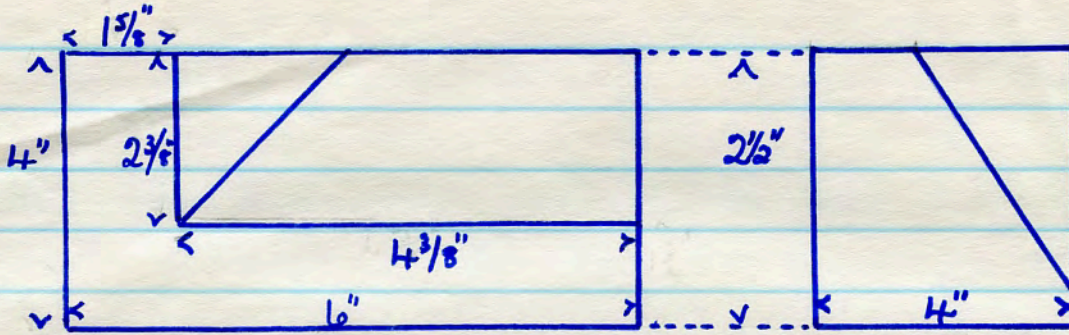

No name. 27 R U R. red T.C. 5 1/2 lbs. left hand.

4207

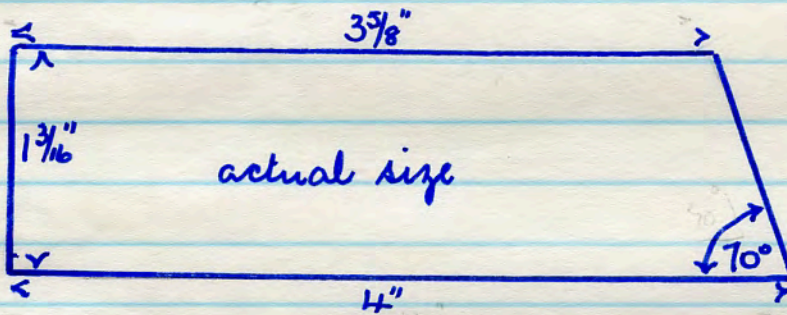

No name
944 VCC
red T.C. 1 3/4 lbs
length 2 5/8"

Acc/ton Mari. dem site 13. 1. '89

No name 248 T 81 red T.C. 5 3/4 lbs

4208

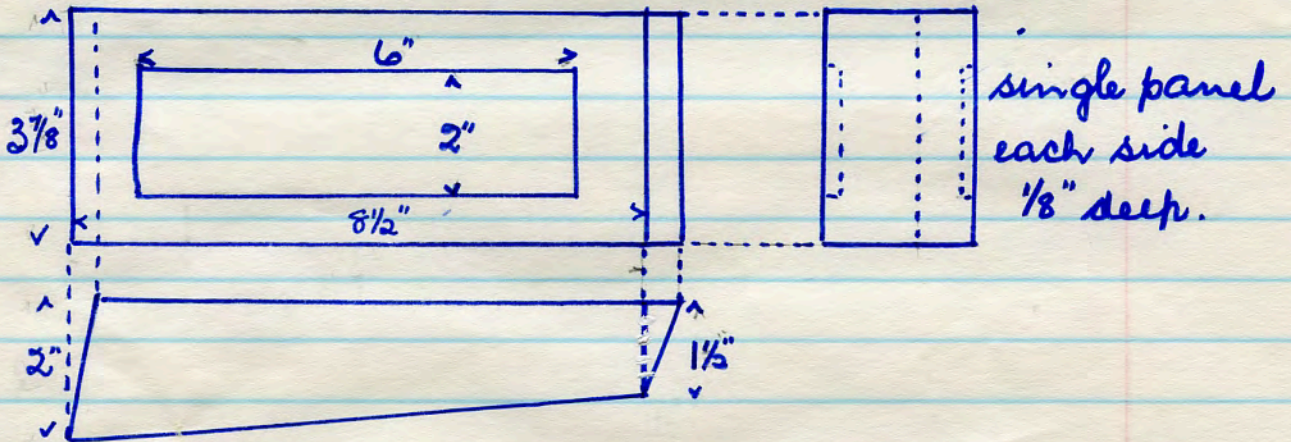

No name. 91 F 6 red T.C.
2 lbs

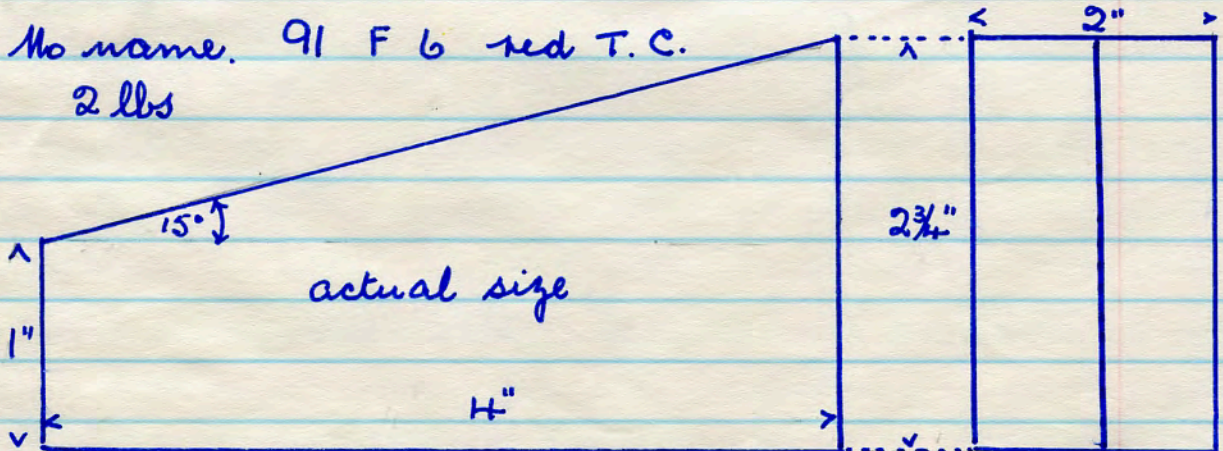

4209

Acc/ton Mari dem. site 12. 1. '89

No name. 57 Q 8X
red T.C. 2 1/2 lbs

H210

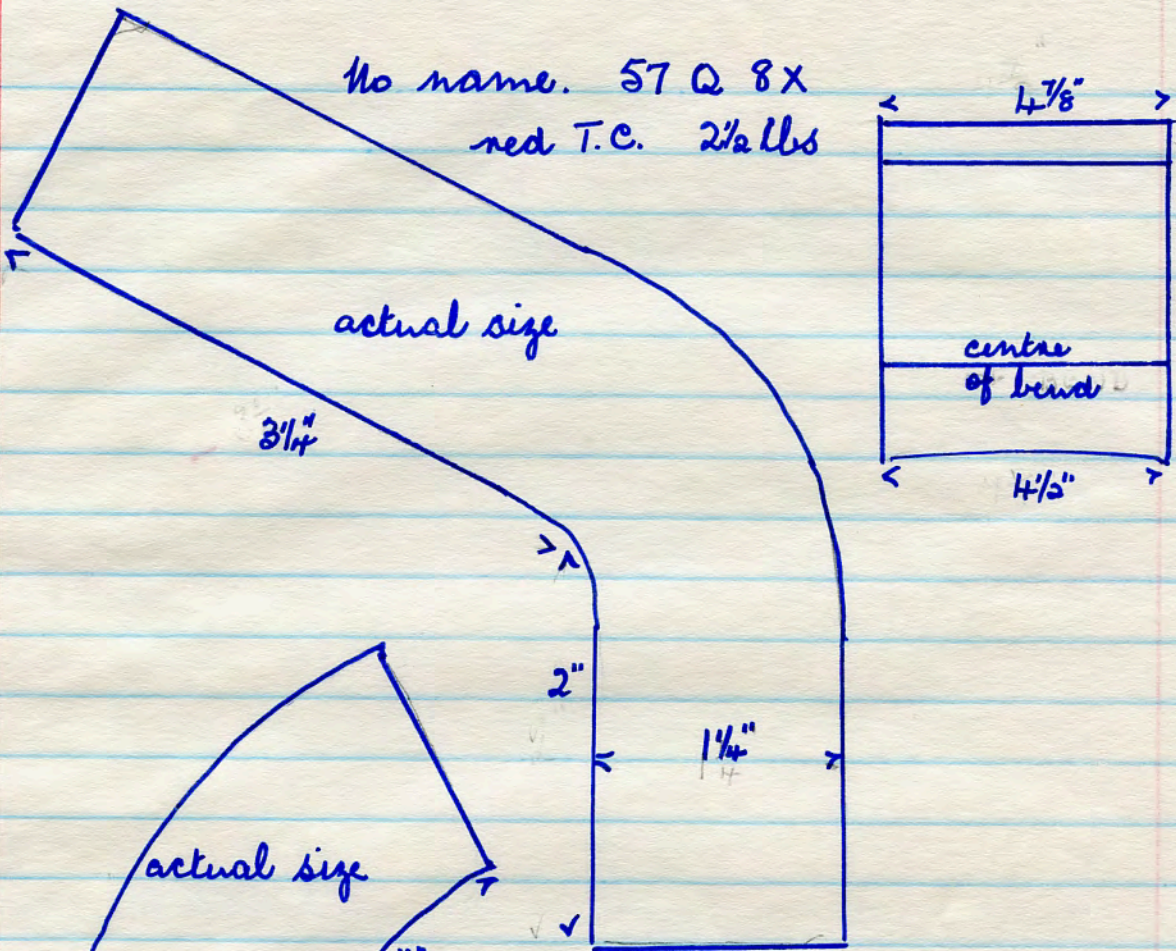

actual size

3 1/4"

2"

1 1/4"

4 7/8"

centre
of bend

4 1/2"

H211

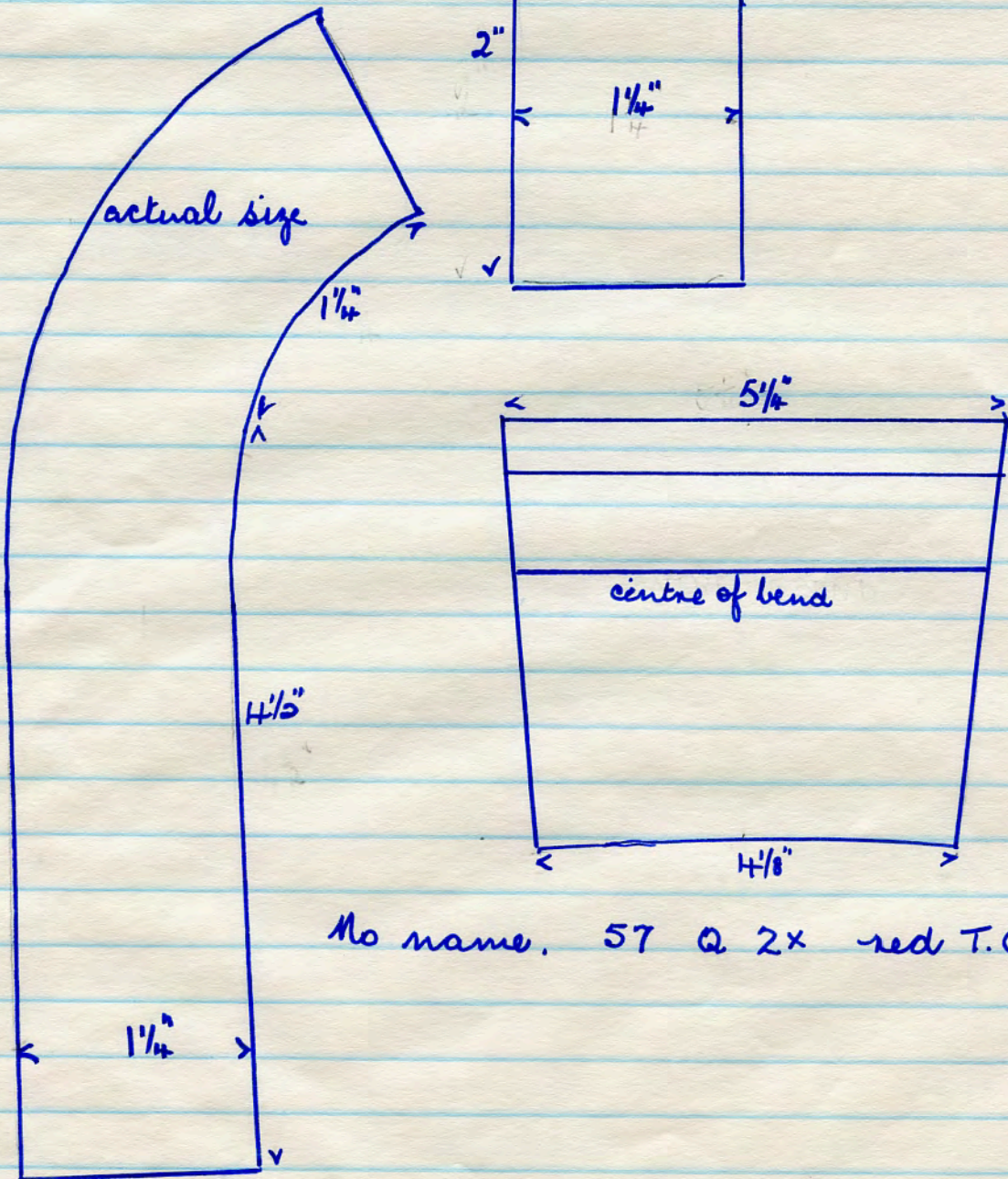

actual size

1 1/4"

4 1/2"

5 1/4"

centre of bend

4 1/8"

No name. 57 Q 2x red T.C. 3 lbs.

Acc/ton Mori dem. site 12. 1. '89

4212

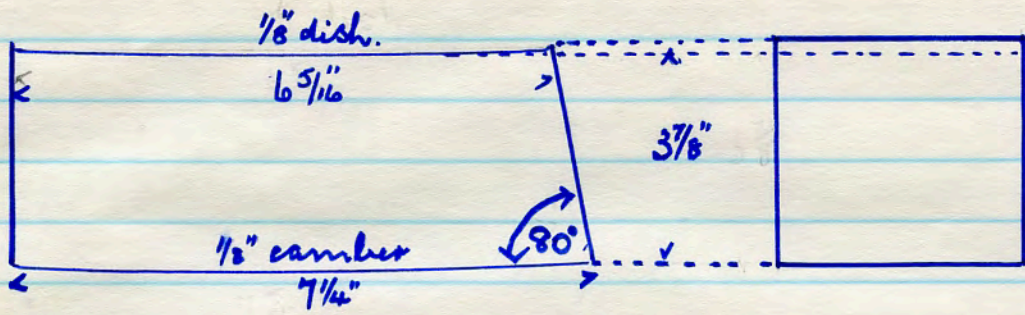

No name
61 Q 446
red T.C.
6 lbs.

4213

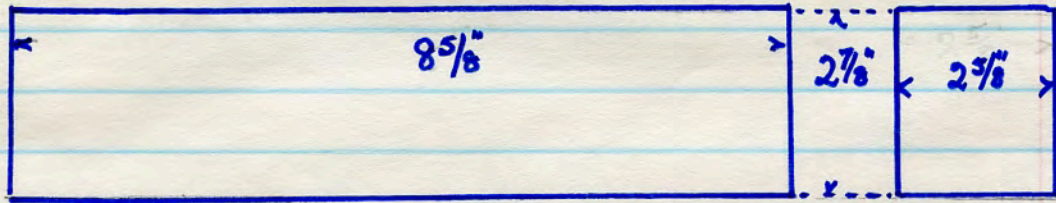

No name
61 Q 452
red T.C.
5 1/2 lbs

4214

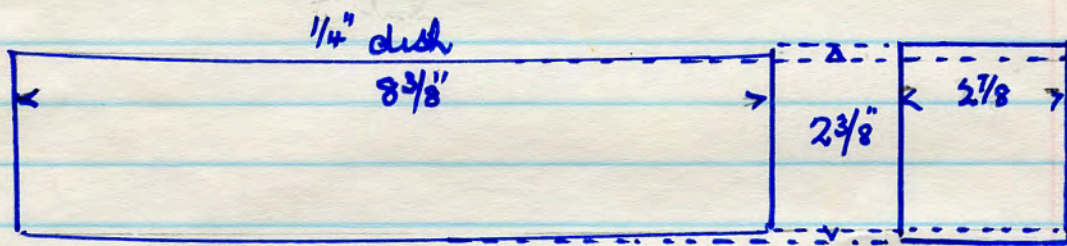

No name
69 Q 11
red T.C.
5 lbs

4215

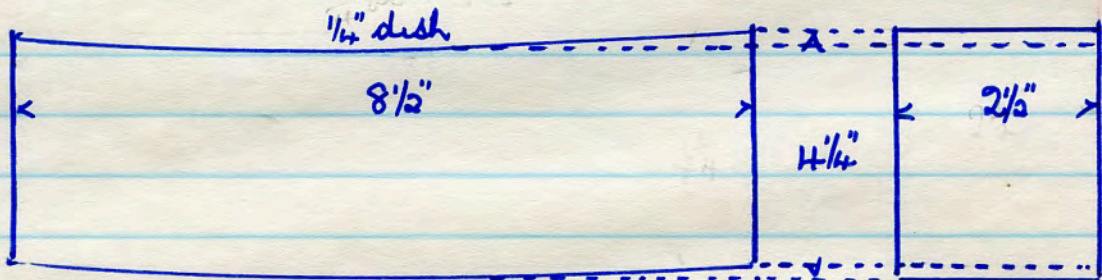

No name
63 M 501
red T.C.
7 1/2 lbs

4216

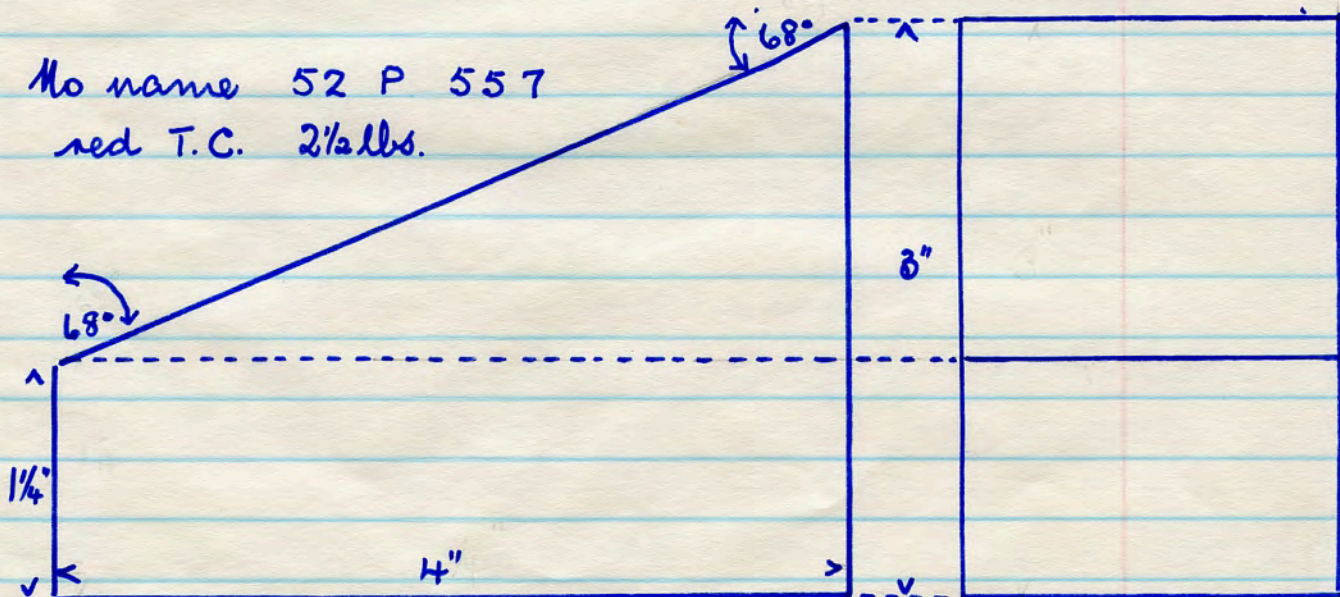

No name 52 P 557
red T.C. 2 1/2 lbs.

Section Mari dem. site 14. 1. '89

4217

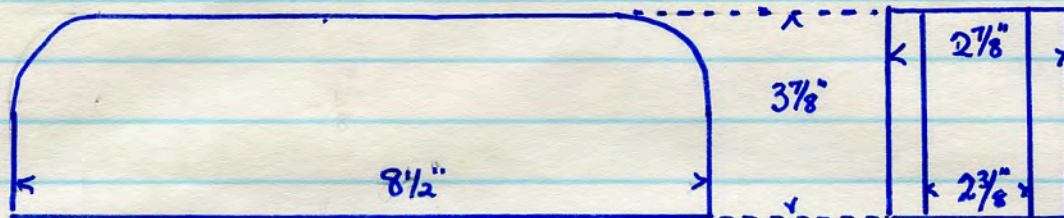

No name
 90 N 50
 red T.C.
 8 lbs.

4218

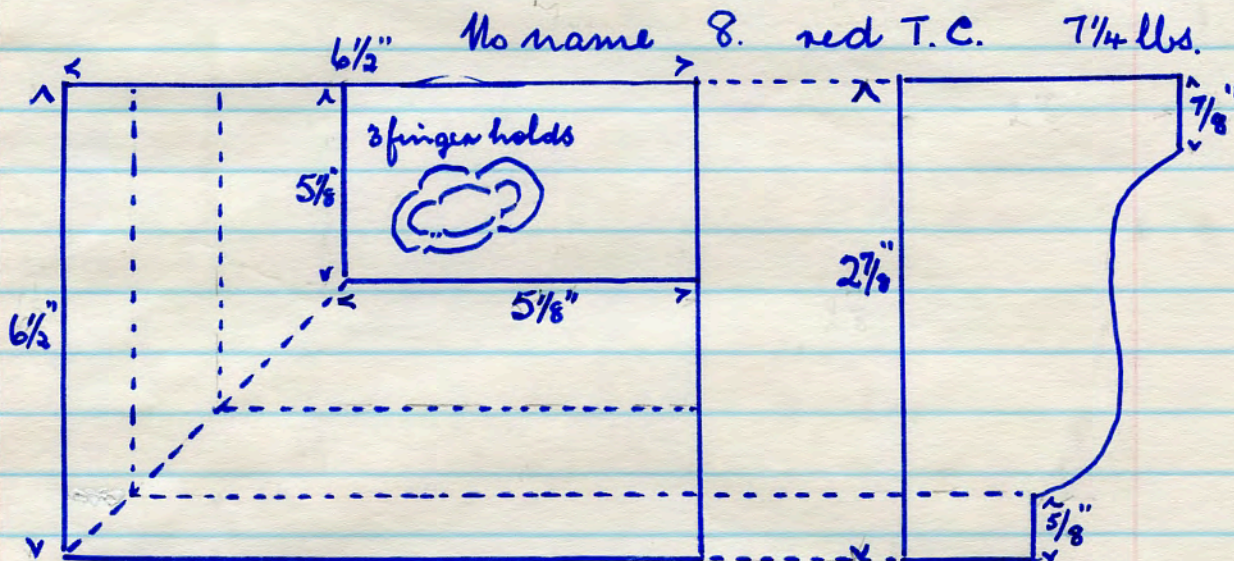

No name 8. red T.C. 7 1/4 lbs.

4219

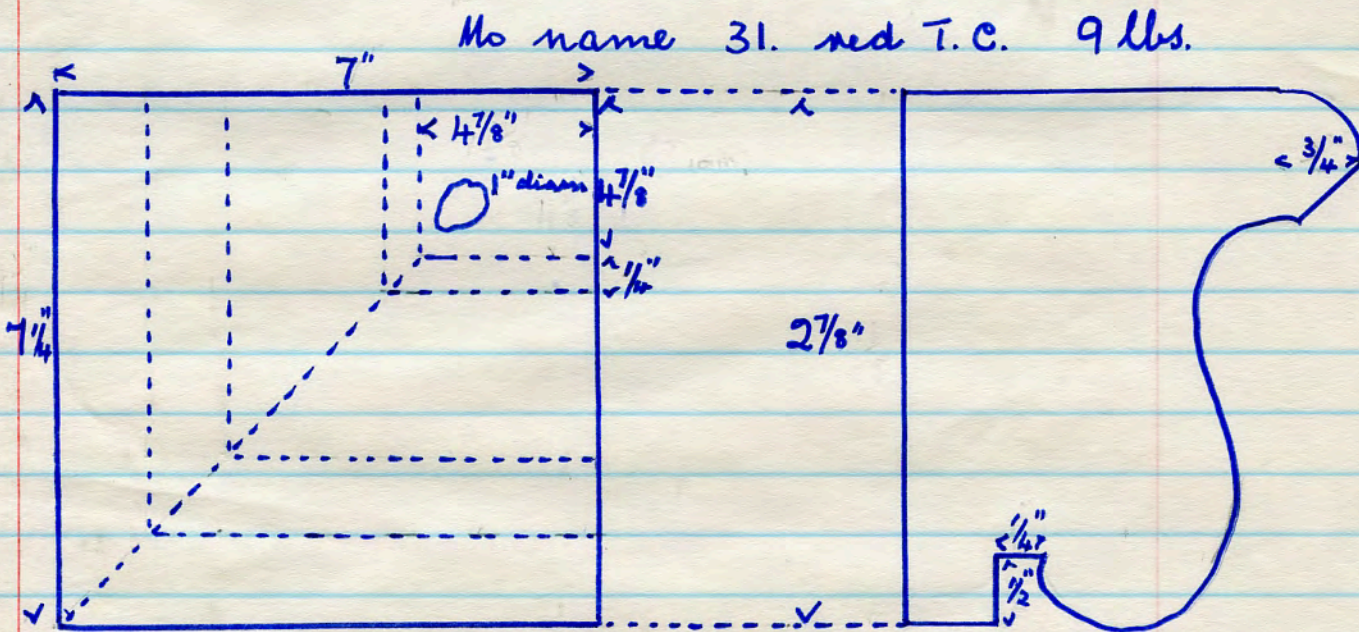

No name 31. red T.C. 9 lbs.

Acclon Mori dem. Site 14. 1. '89

4220

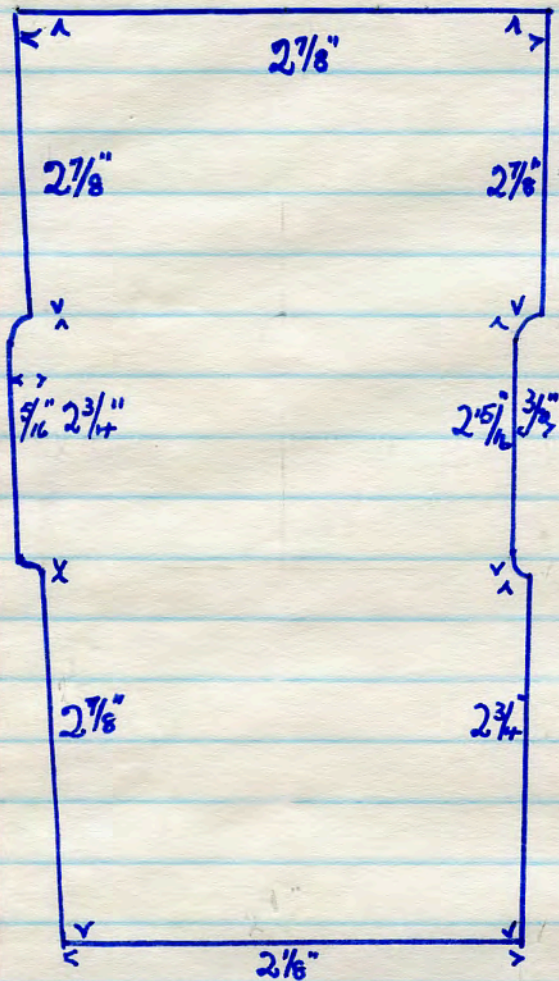

No name. Red T.C. segment
to form 4' 6" diam. circle.
Moulder's mark HB
Weight 14 lbs.

4221

No 2. No name. Red T.C. segment to form 3' 0" diam ^{circle}
similar to No 1. in shape.
Variation in size. - 2 3/16" top width, 2" base width
Moulder's mark. J C.
Weight 14 lbs

4222

No 3. No name. Red T.C. segment to form 2' 0" diam. circle
similar to No. 1 in shape.
Variation in size - 2 3/4" top width, 1 1/16" base width
Moulder's mark. J C
Weight 14 lbs.

4223

Acfton Moni dem. site 14. 1. '89
No. 4 No name. ~~5' 6"~~ red T.C. as above. top 2 7/8", base 2 1/4"
Weight 15 lbs. Moulder's mark J C

Mo name 43 d 315 red T.C. 24 lbs.

4224

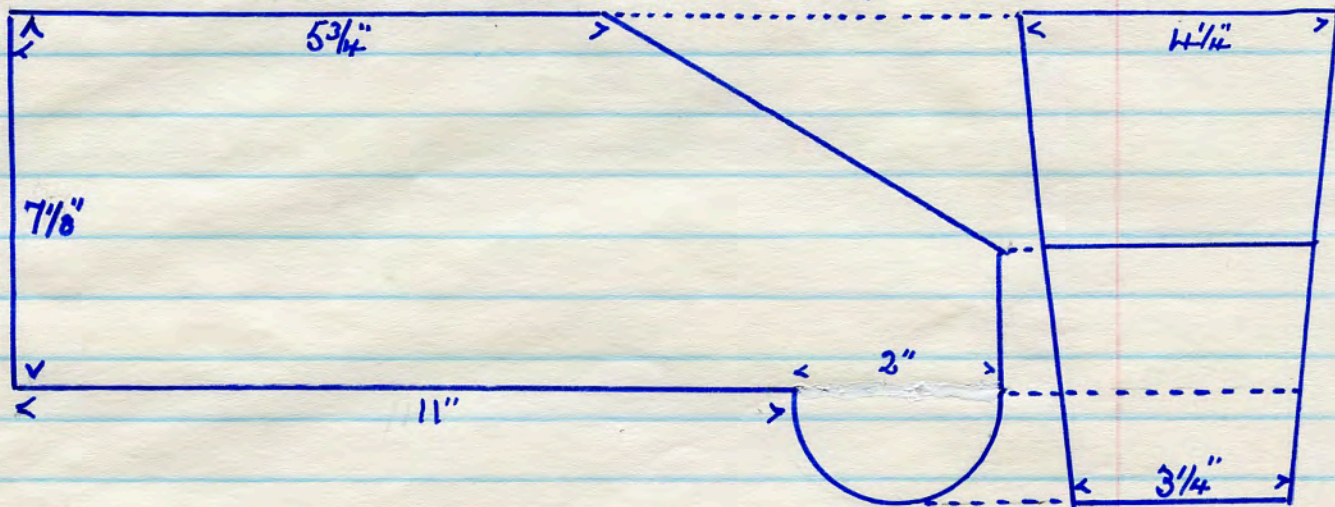

Mo name 91 N 5A
red T.C. 14 lbs.
moulder's mark X

4225

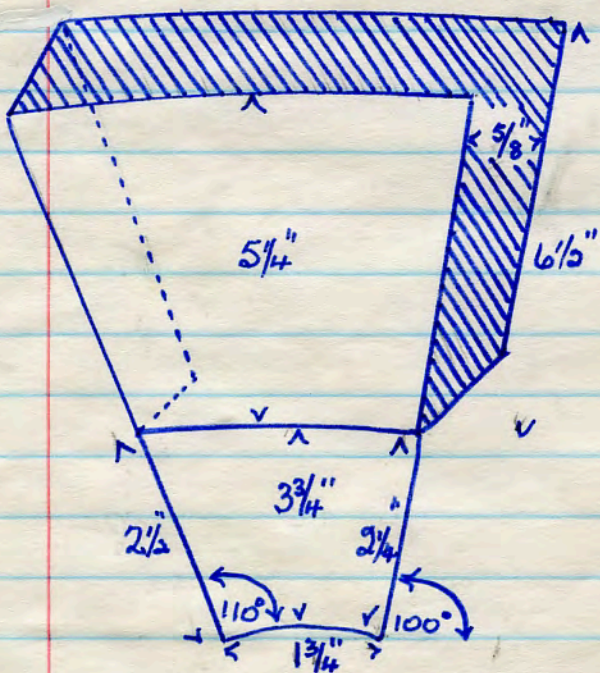
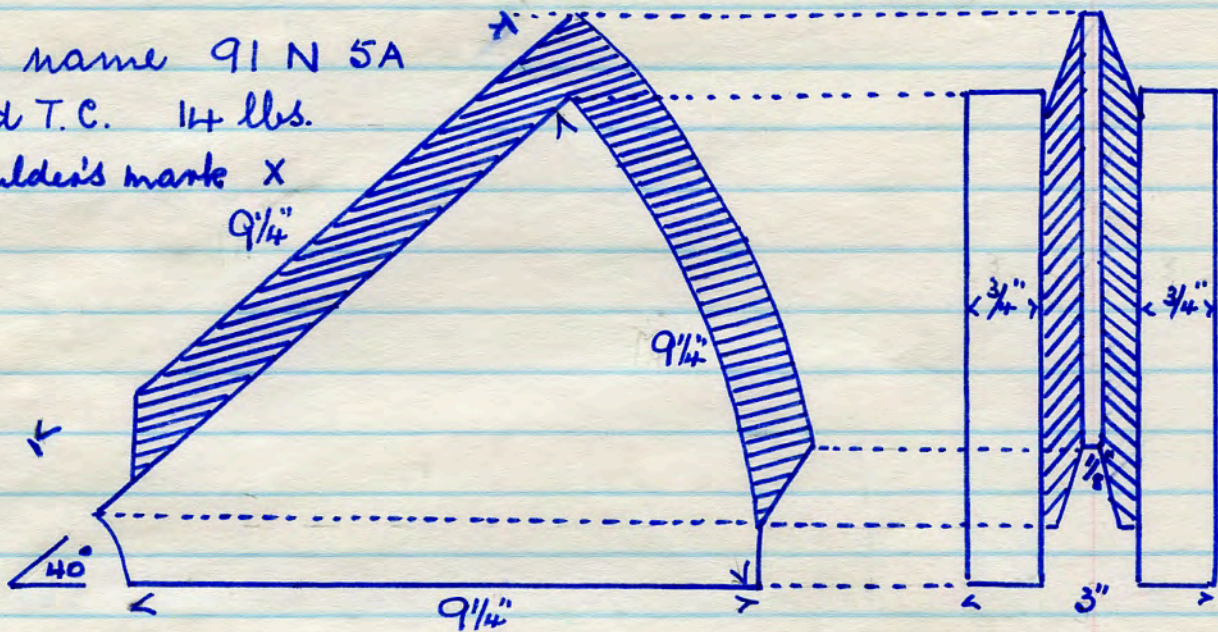

4226

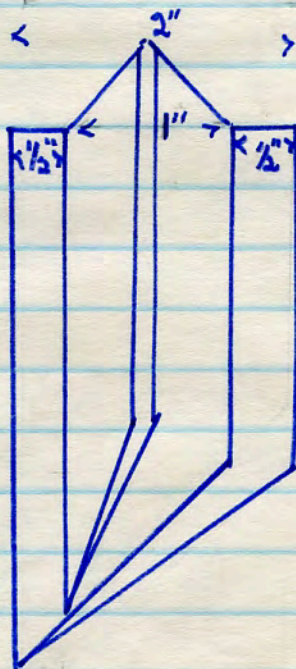

Mo name
98 H 1
red T.C.
3 lbs.

Acceptor Mori dem. site

4227

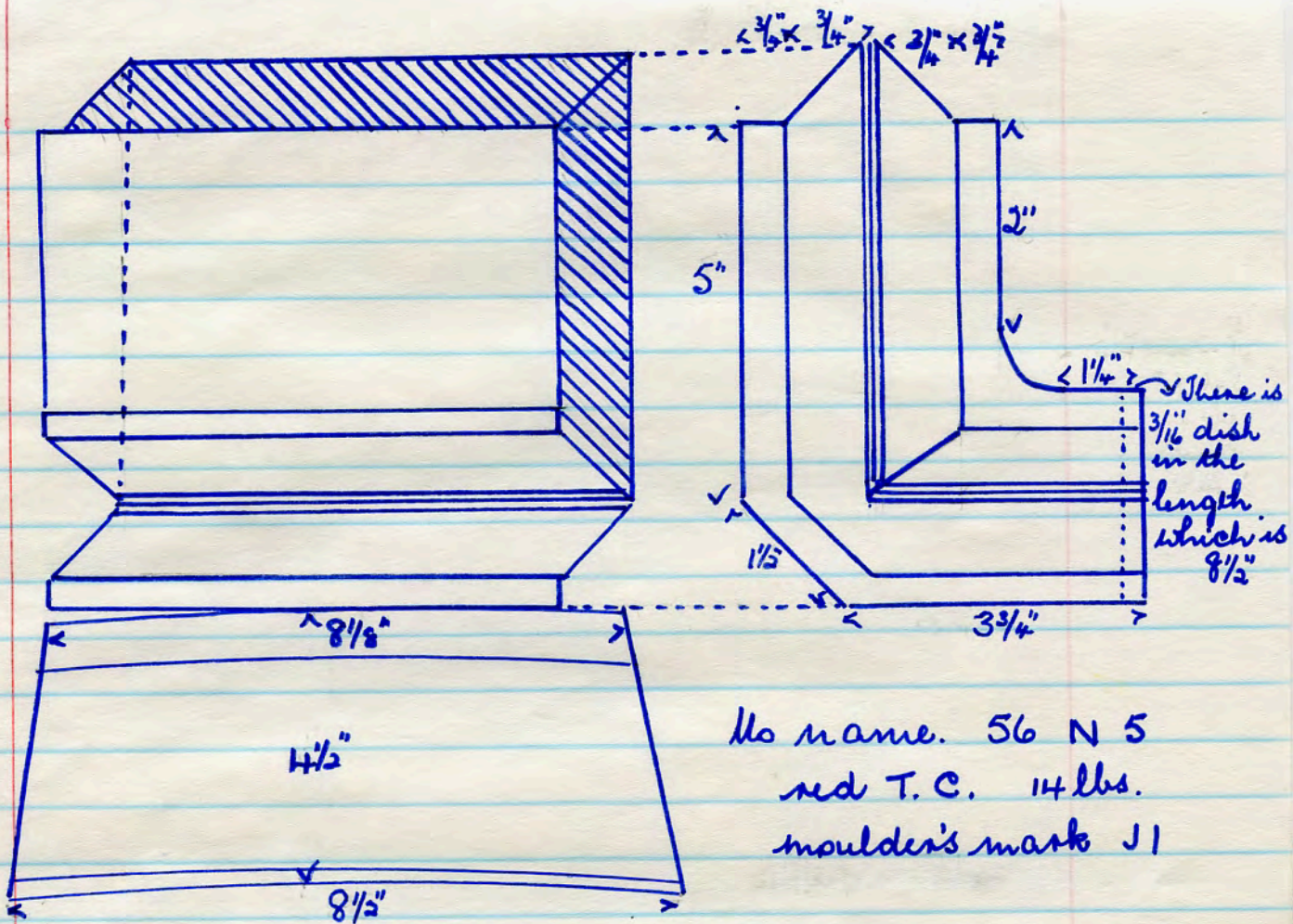

No name. 56 N 5
red T.C. 14 lbs.
moulder's mark J1

Acpton Mori dem. site 14. 1. '89

4228

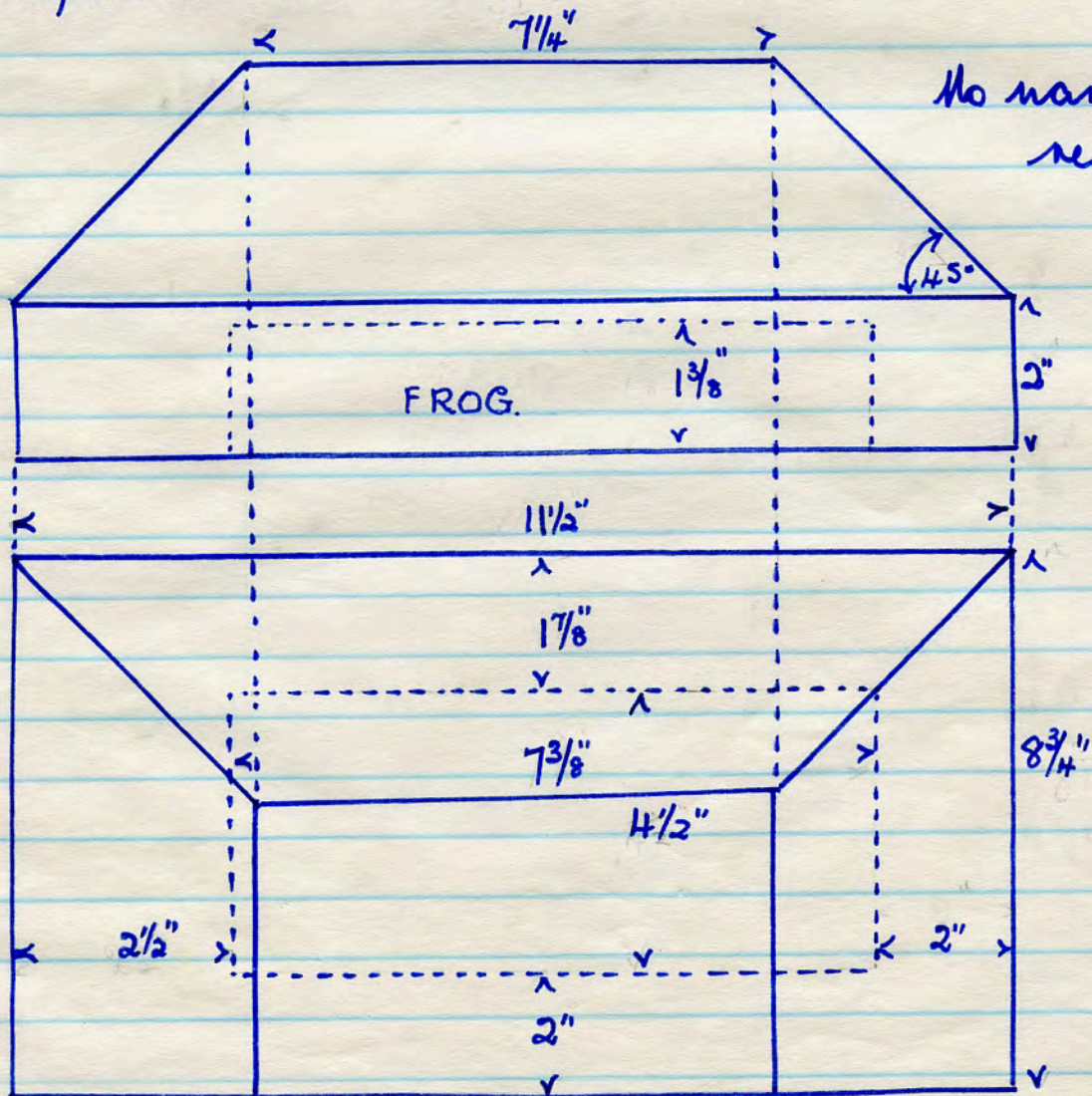

No name 185 TA
red T.C
24 lbs.

Acpton Mori dem. site 19. 1. 89

4229

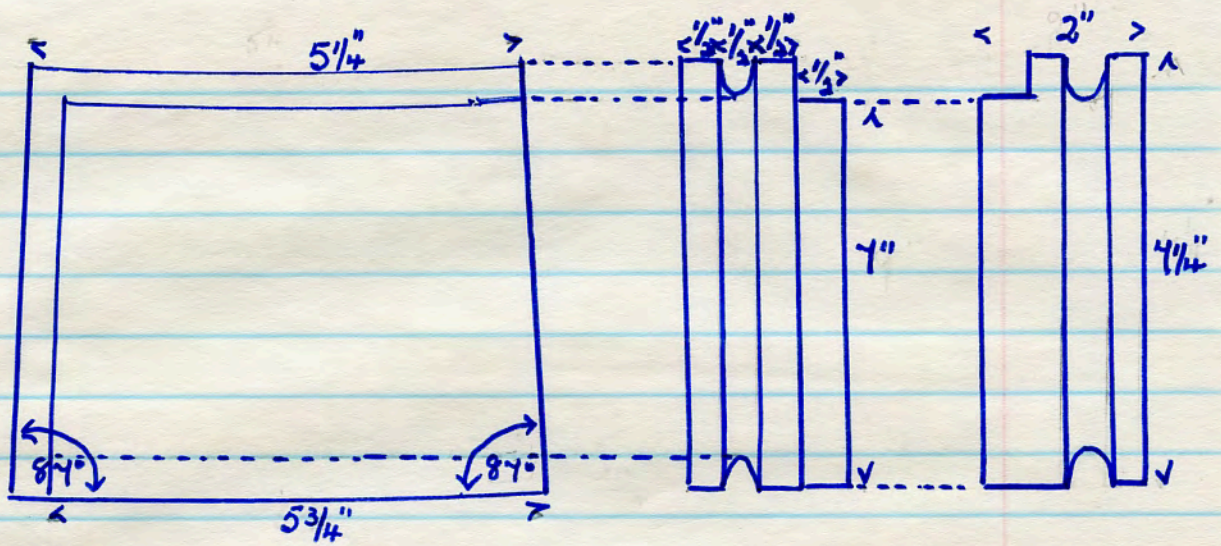

No name 24 B 6 X red T.C. 6 3/4 lbs. moulder's mark DN
 Acc/Kon Hori dem. site 19. 1. '89

No name 346 TA
 red T.C. 11 lbs
 4 x 1/4" perfs.

4231

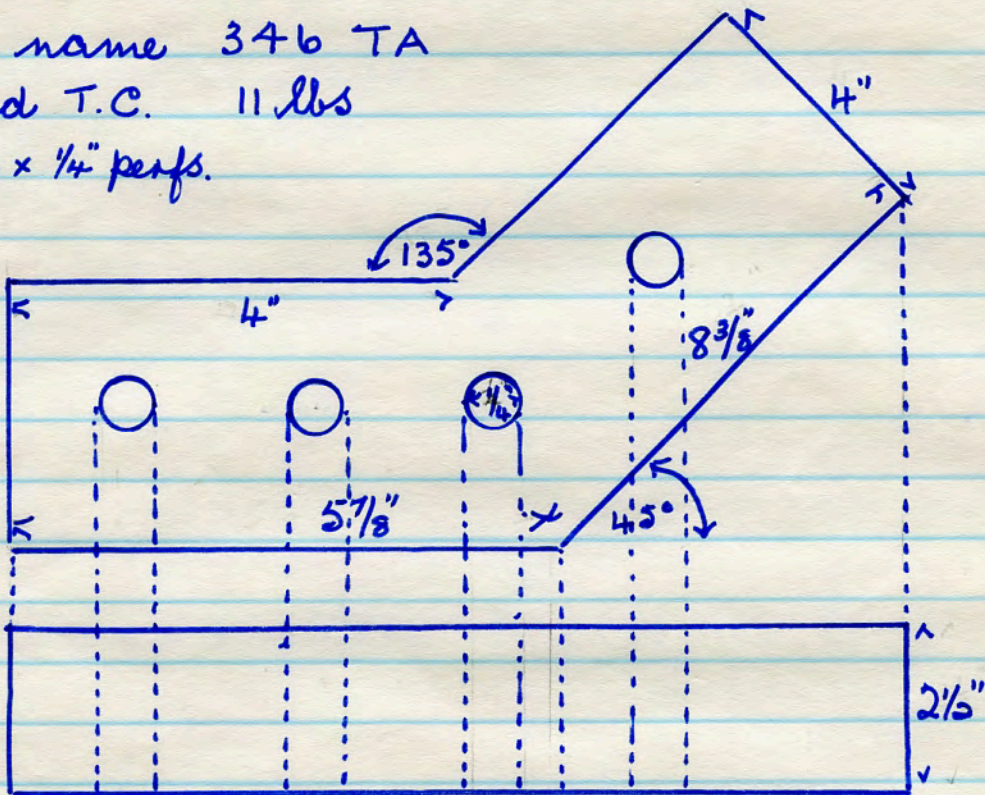

No name. 6SS red T.C. 28 lbs.

4230

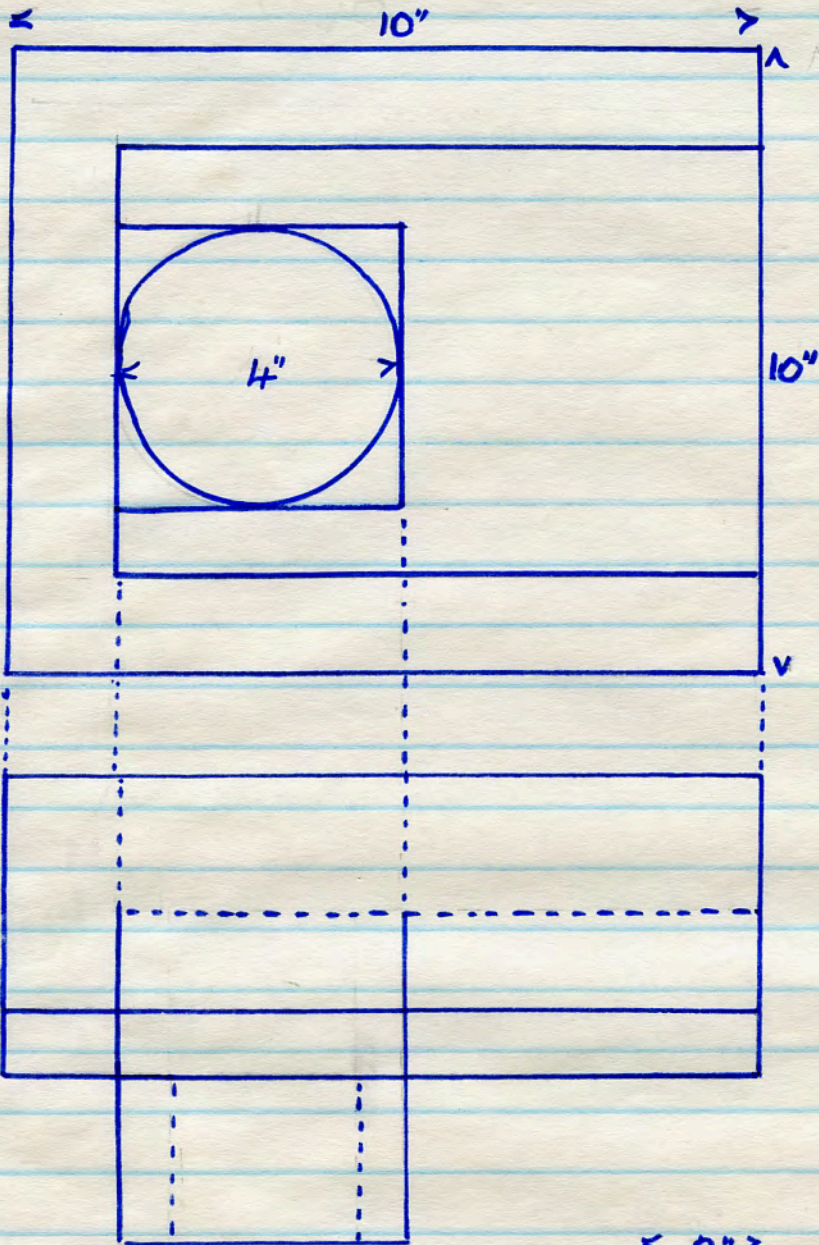

Accepted Mori dem. site
19. 1. '89

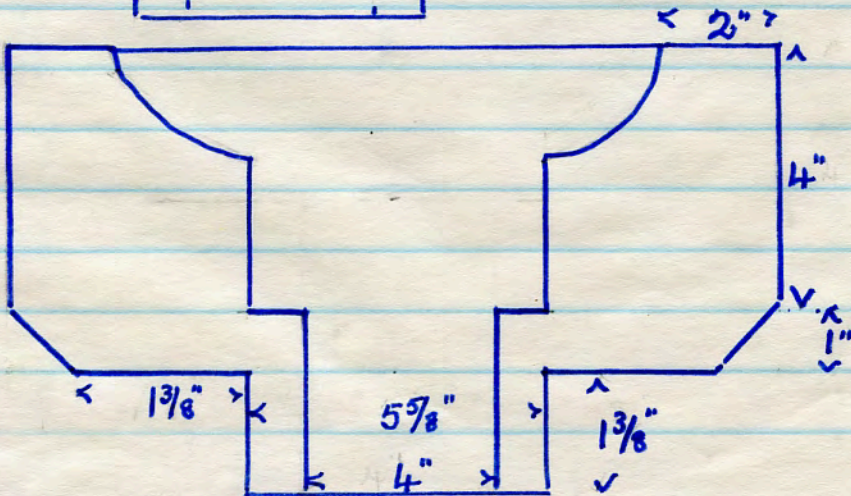

4232

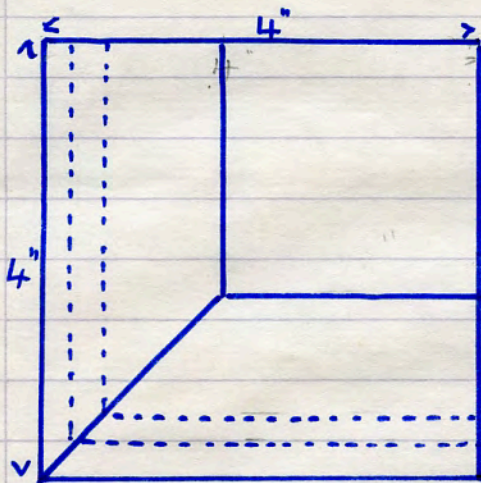

No name 295 T.A
red T.C. 2 1/2 lbs

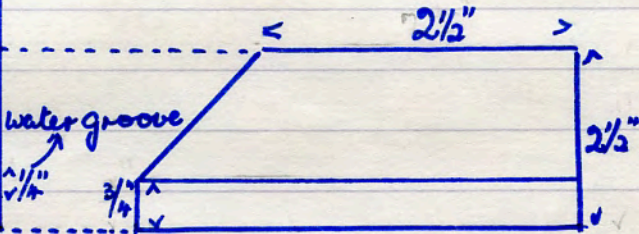

4233

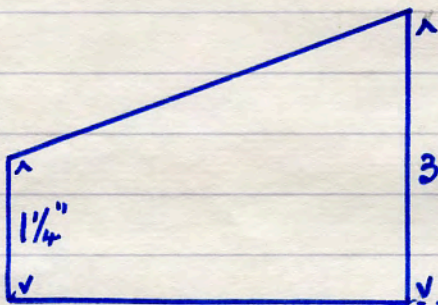

No name 52 P 557 red T.C.
1 3/4 lbs

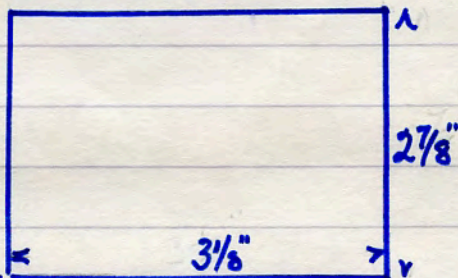

4234

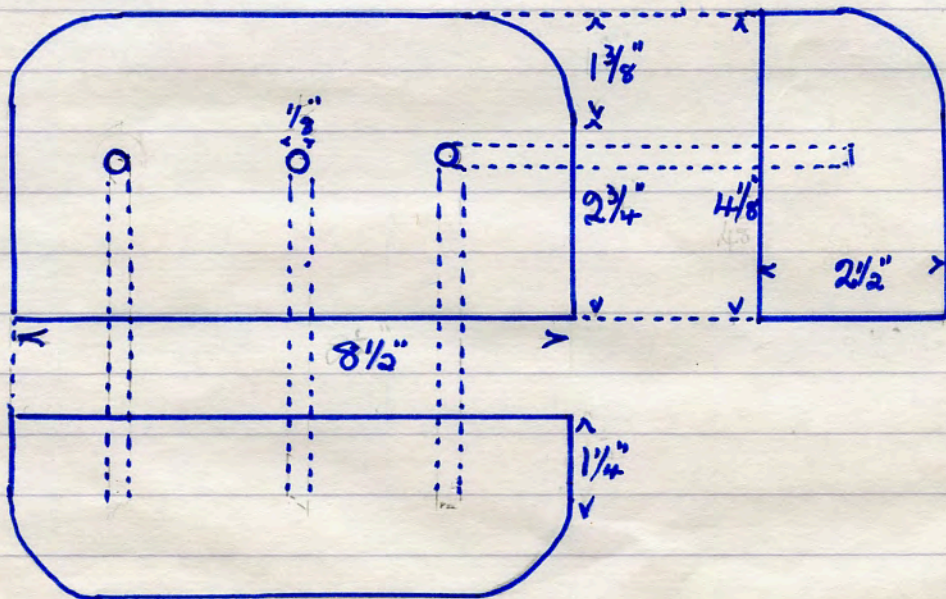

Ashton Mass dem. Site 20. 1. '89

Wire sun brick. Metric sizes 2512 AR 7 lbs

4235

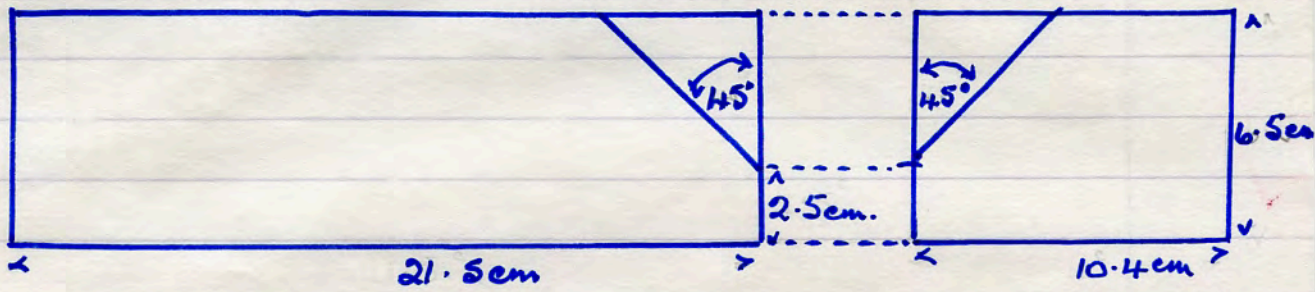

21.5 cm x 10.4 cm x 6.5 cm.

ACCRINGTON NORI ACCRINGTON. wire sun N2
8 lbs. letters stamped 1 edge only. rustic finish 3 edges

4236

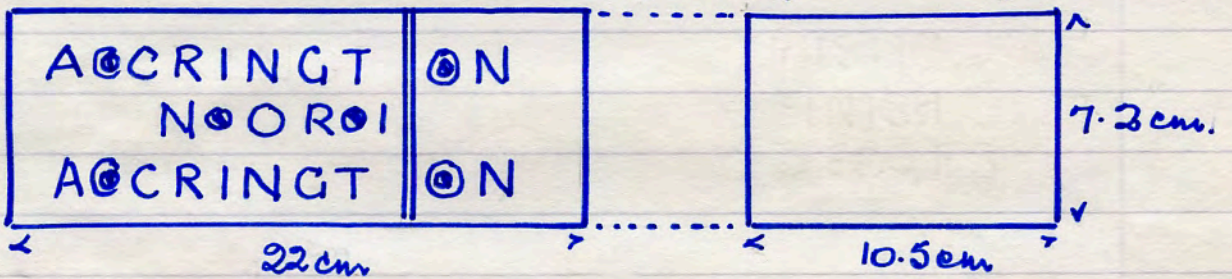

22 cm x 10.5 cm x 7.2 cm.

No name 769 Y red T.C. 8 lbs pencil mould on

4237

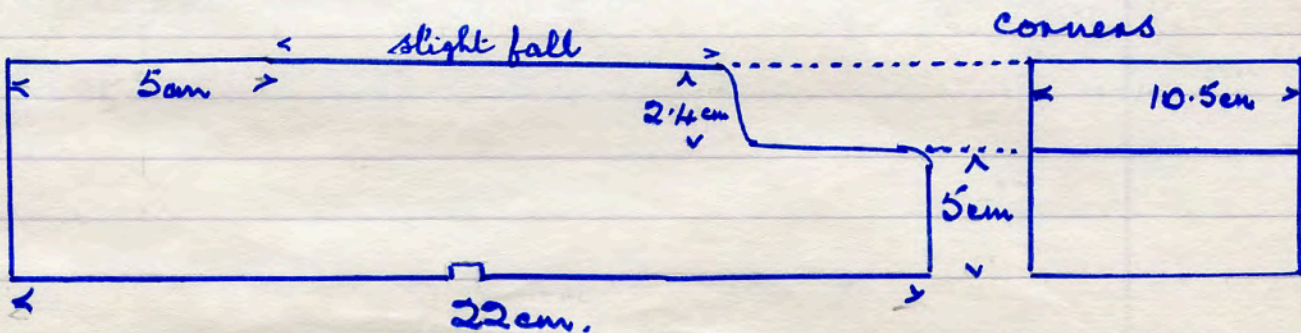

No name 5 incised in small panel. hand pressed blk.
8 lbs

4238

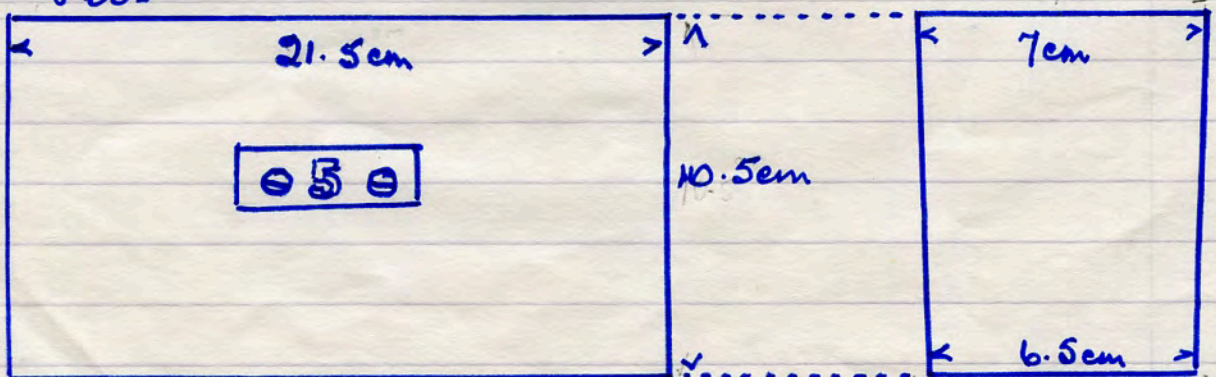

Acc/ton Moni dem. site 20. 1. '89

4239

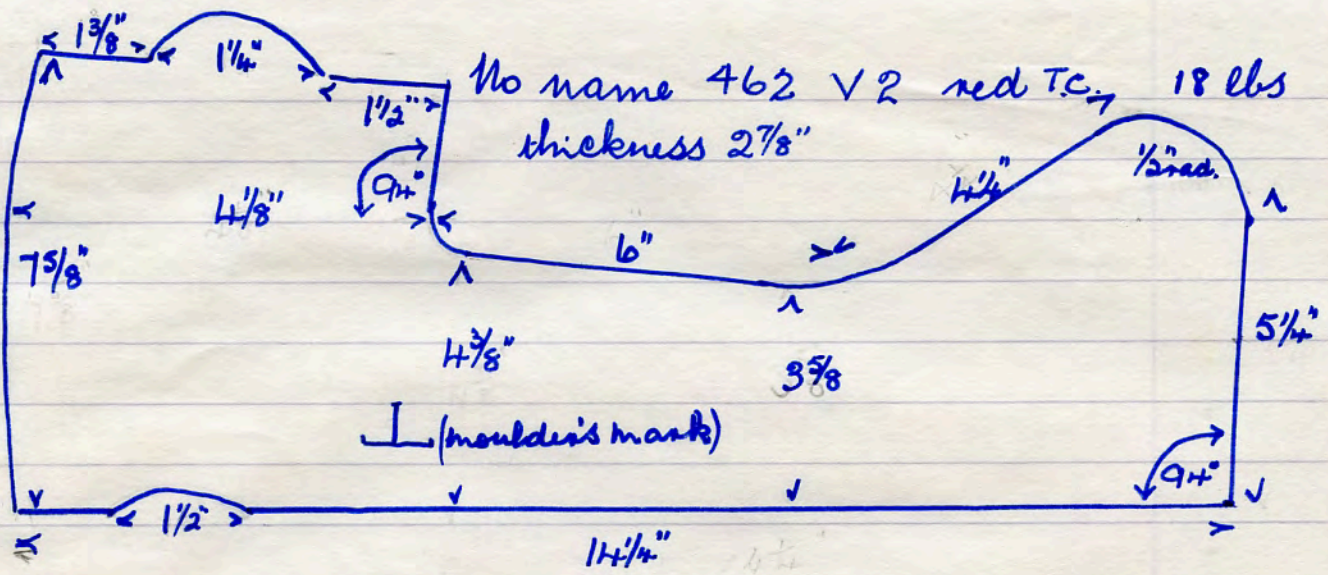

No name 462 V2 red T.C. 18 lbs
thickness $2\frac{7}{8}$ "

4240

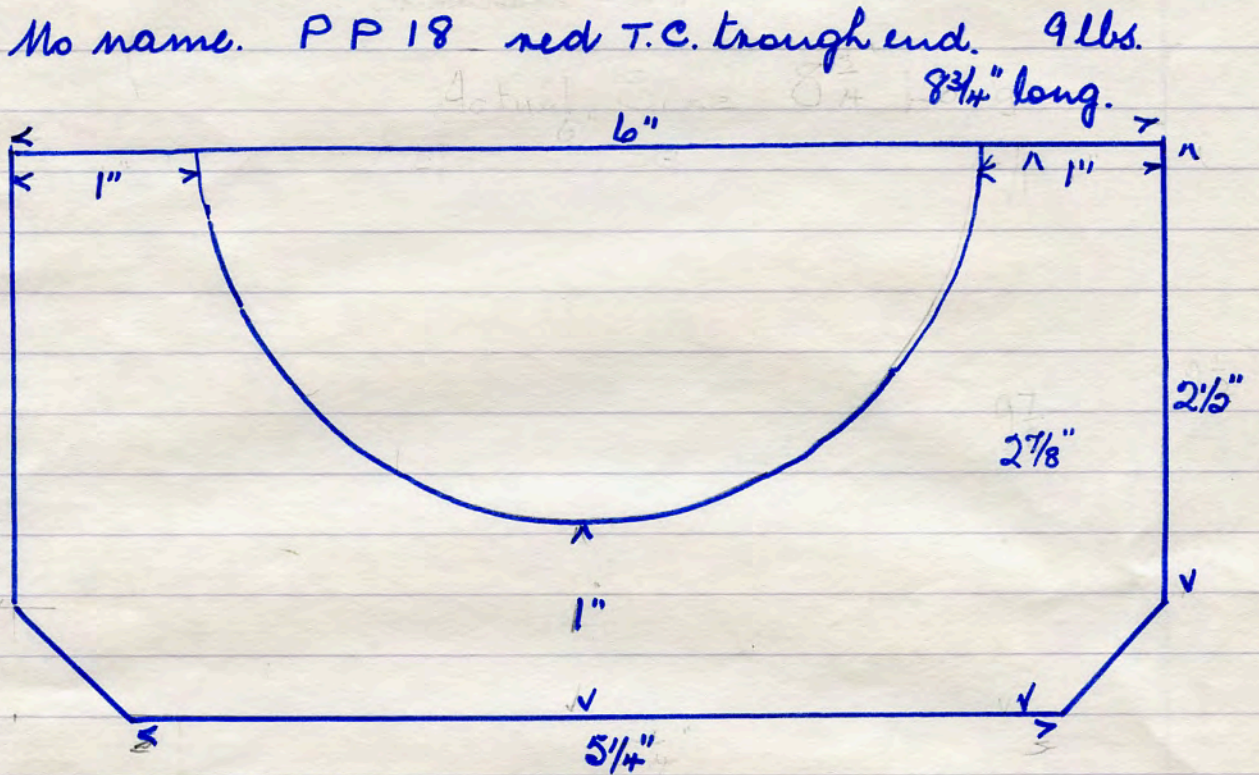

No name. PP 18 red T.C. trough end. 9 lbs.
8 $\frac{3}{4}$ " long.

4241

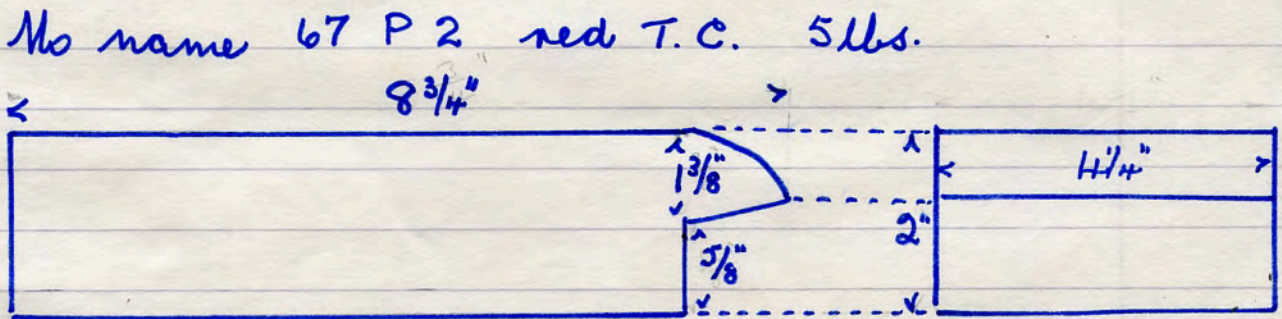

No name 67 P 2 red T.C. 5 lbs.
8 $\frac{3}{4}$ "

4242

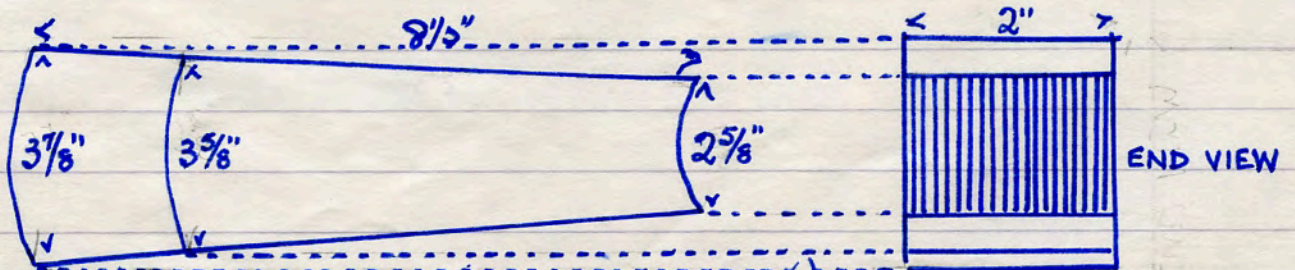

No name. 38 L1 red T.C. 6 lbs.
Action Hosi dem. site 22. 1. '89

4243

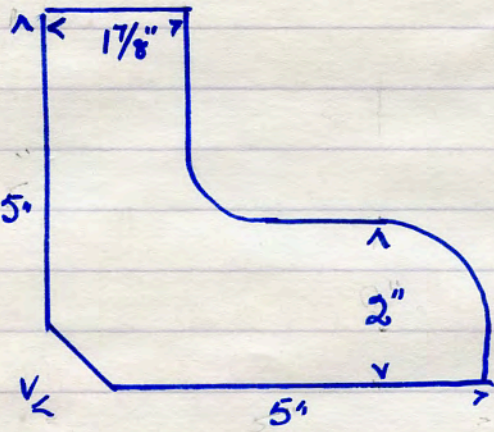

No name PN 5A
 red T.C. length $8\frac{1}{2}''$
 11 lbs.

4244

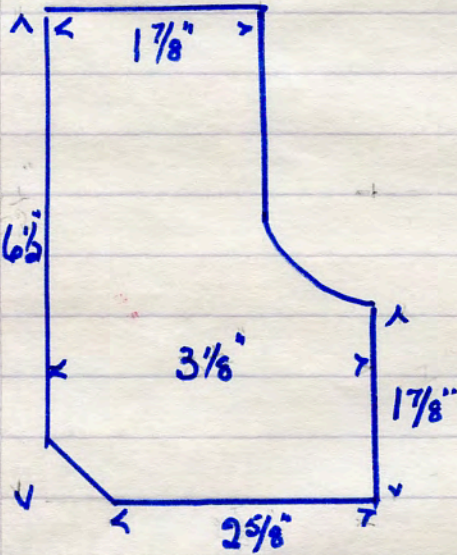

No name P 27
 red T.C. length $8\frac{5}{8}''$
 12 lbs

4245

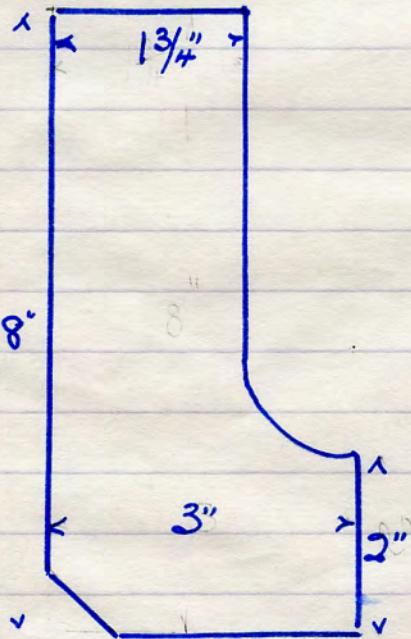

No name. 50 W
 red T.C. length $8\frac{5}{8}''$
 12 lbs.

Accepton Maui dem. site 22. 1. '89

4246

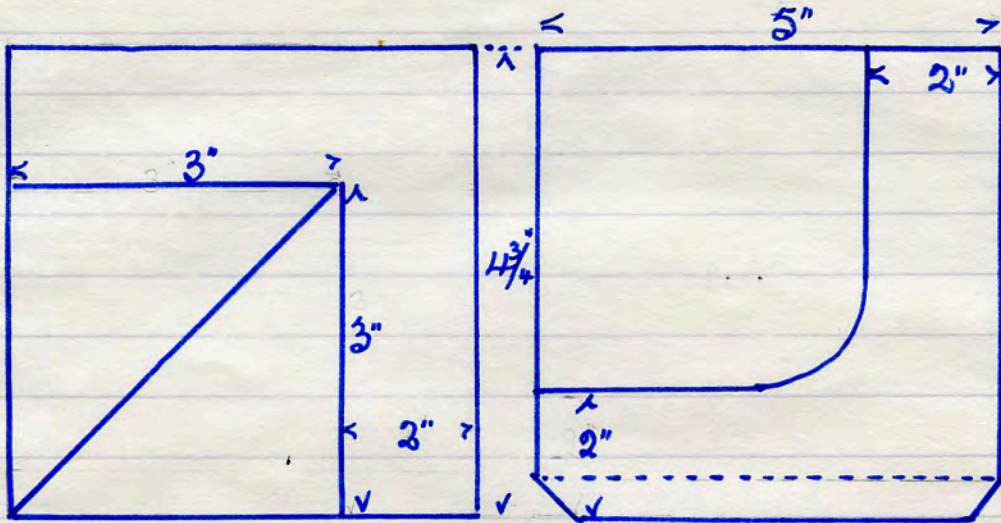

No name
PN 7
red T.C.
5 lbs

4247

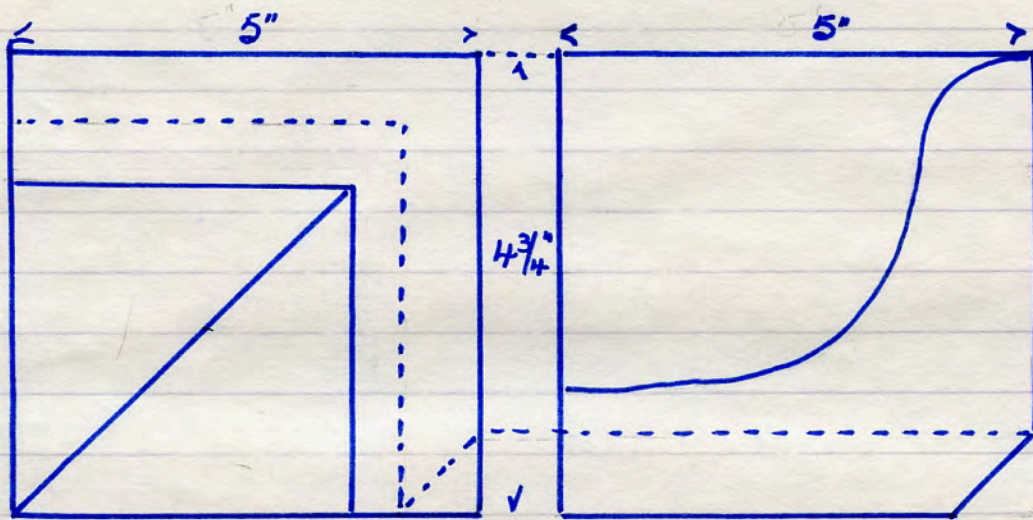

No name
PN 7A
red T.C.
7 lbs.

4248

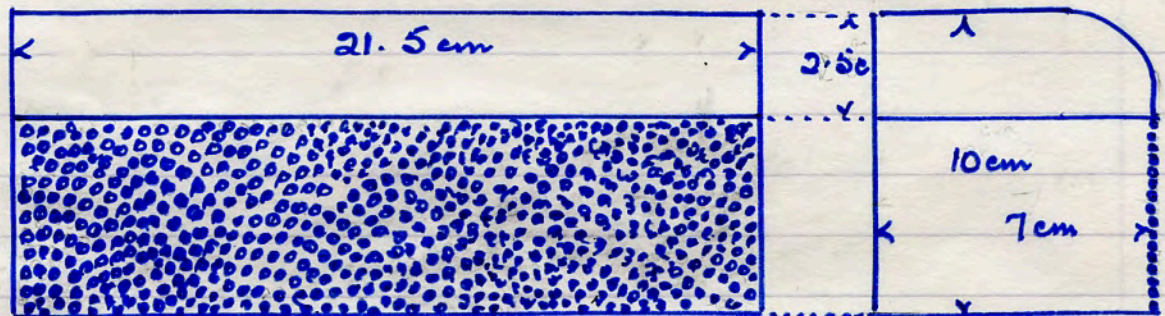

No name PN red T.C. patterned edge tile 8 lbs.

4249

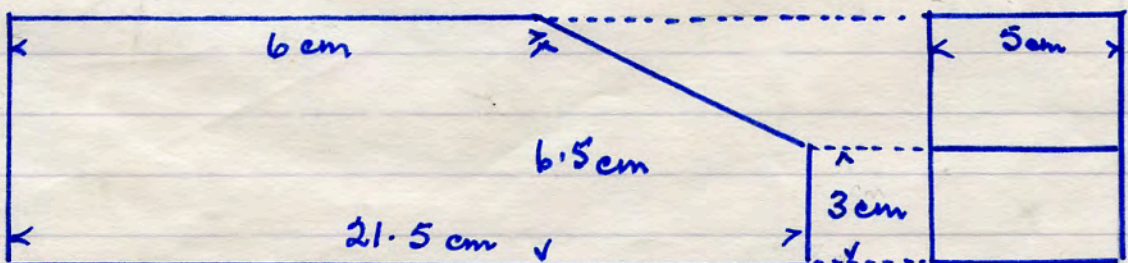

No name. 37 R red T.C. 4 lbs.
Acpton Moni dem. site 22. 1. '89

4250

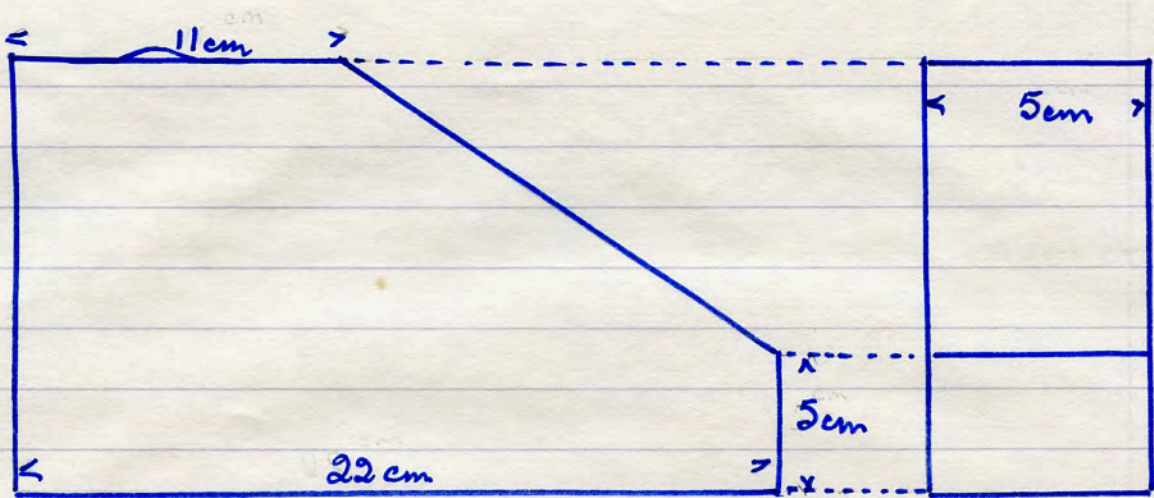

No name 849 UA red T.C. 6 lbs.

4251

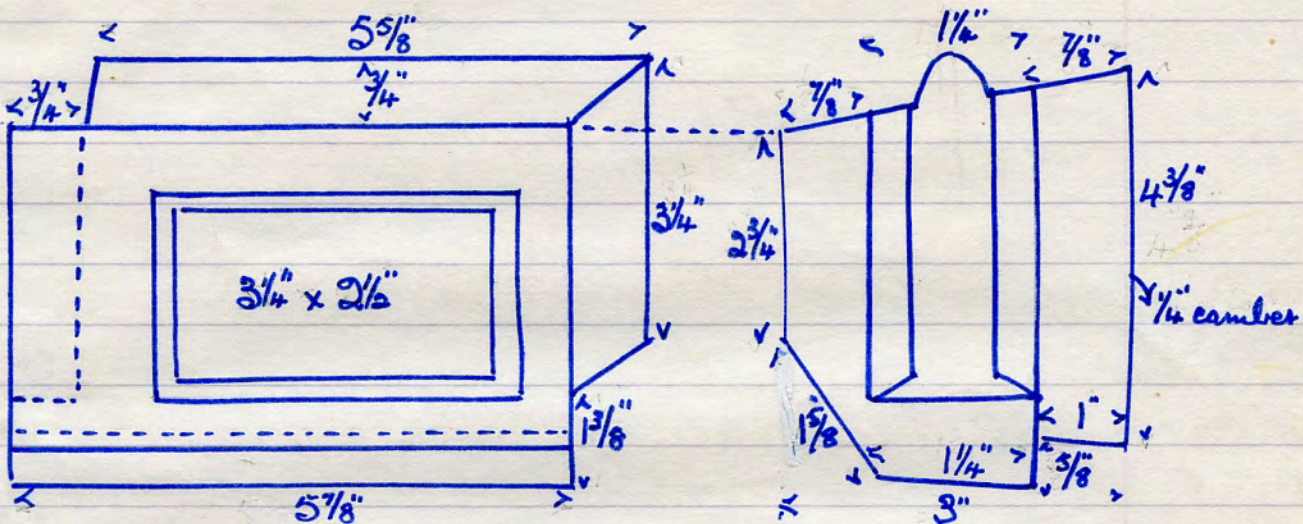

No name 79 F 14 red T.C. 7 lbs.

Acpton Mori dem. site 22. 1. '89

4252

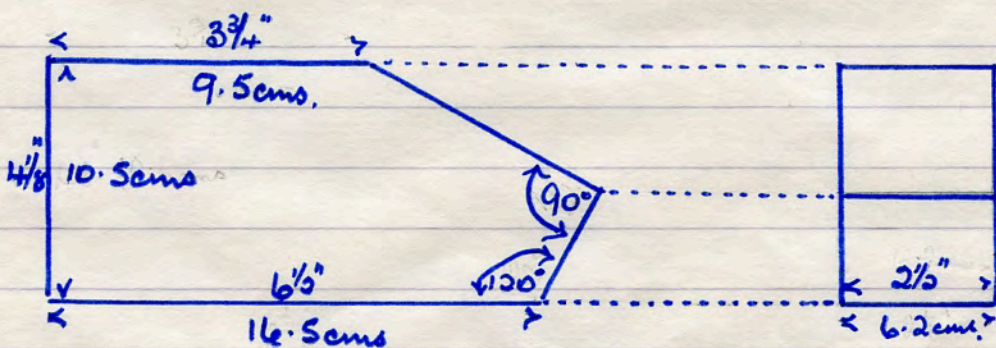

No name 24 13C dark brown 4 lbs.
Acpton Mori dem. site 2. 2. '89

4253

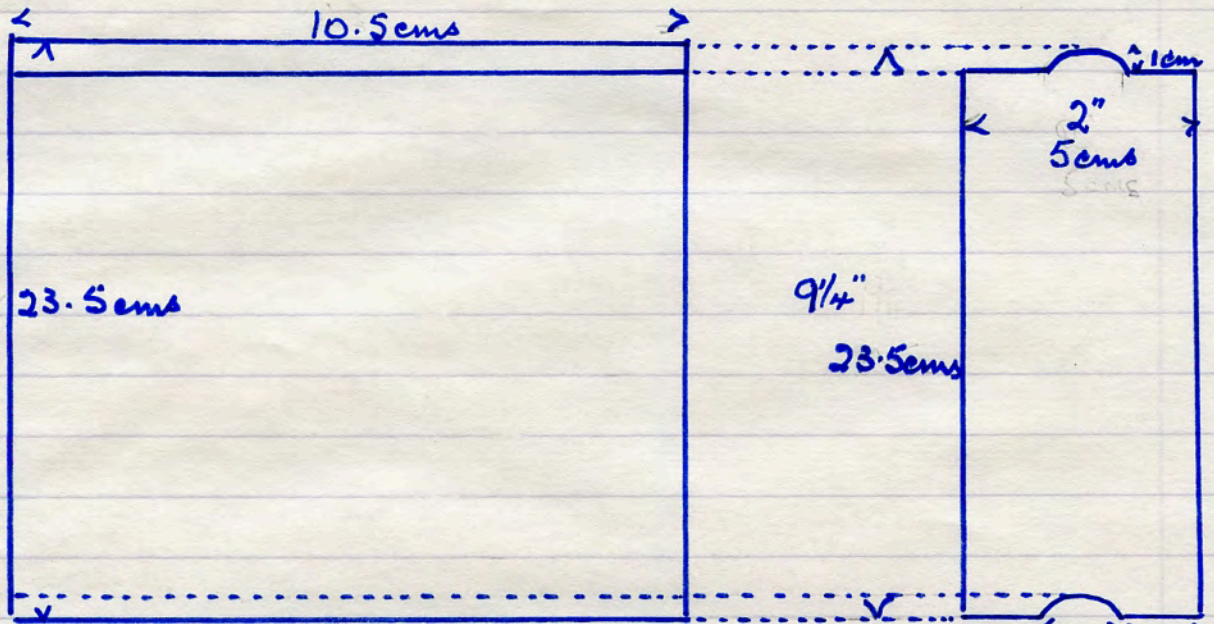

No name 85 Q red T. C. 7 lbs.

1.3" 2.5" 1.2" cms.

4254

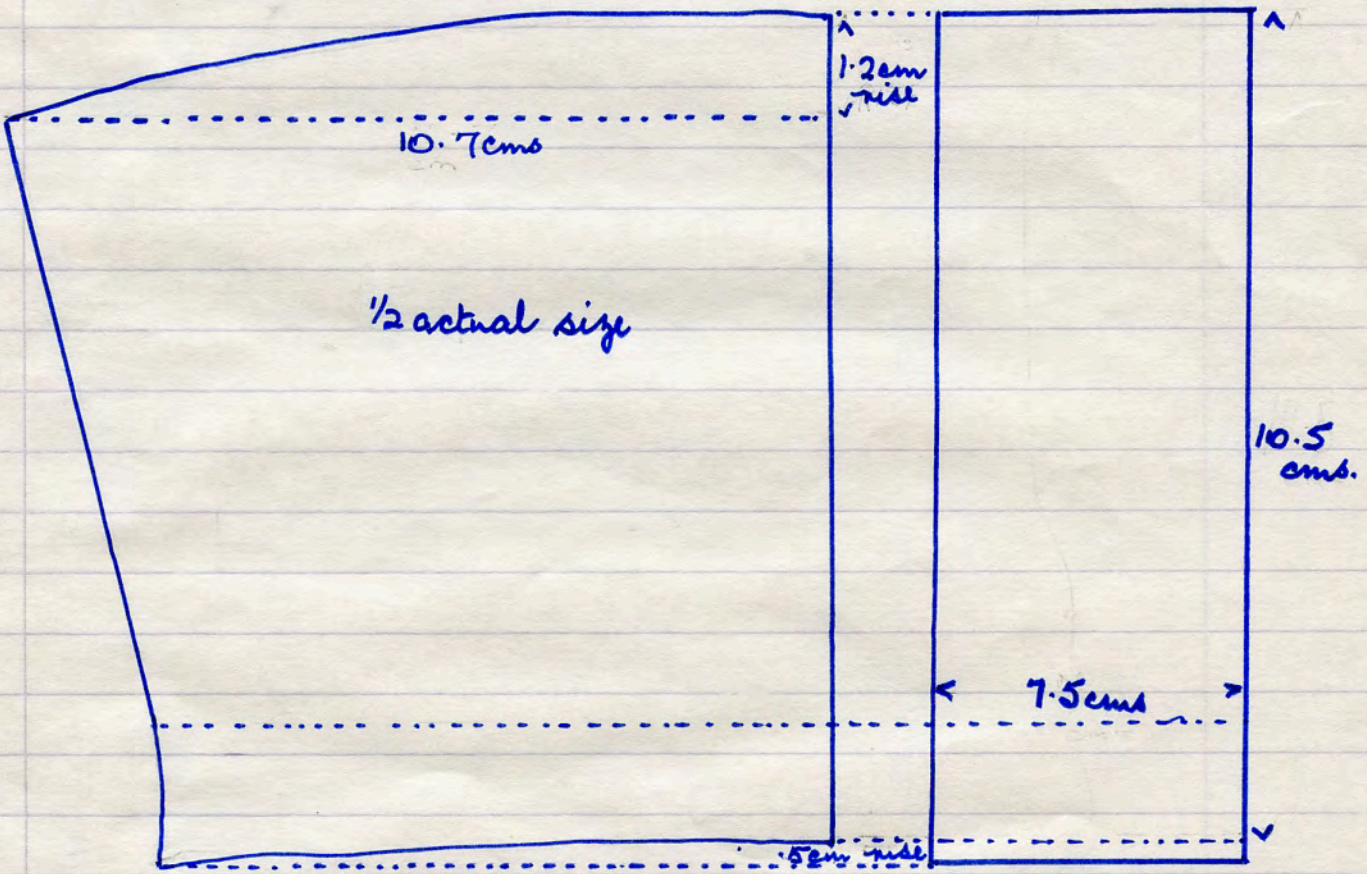

No name 18. red T. C. 8 lbs.

Acfton Mori dem. site 2. 2. '89

H255

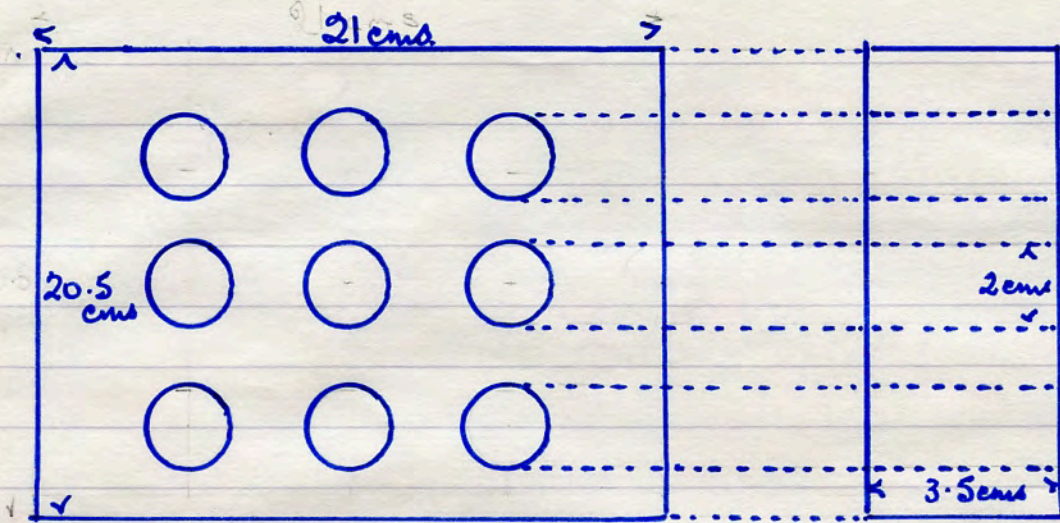

No name 119 U red T.C. 7 lbs.

No name 228 99B red T.C. 9 lbs.

H256

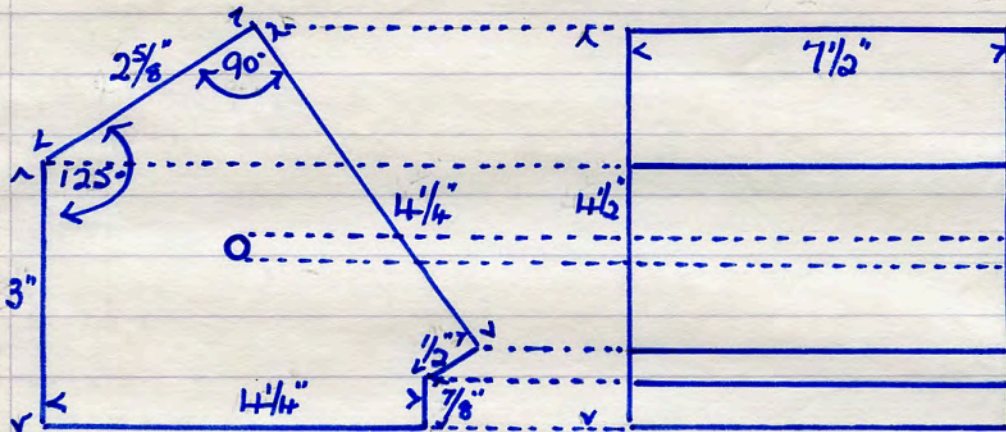

No name 232245 RA red T.C. 14 lbs

H257

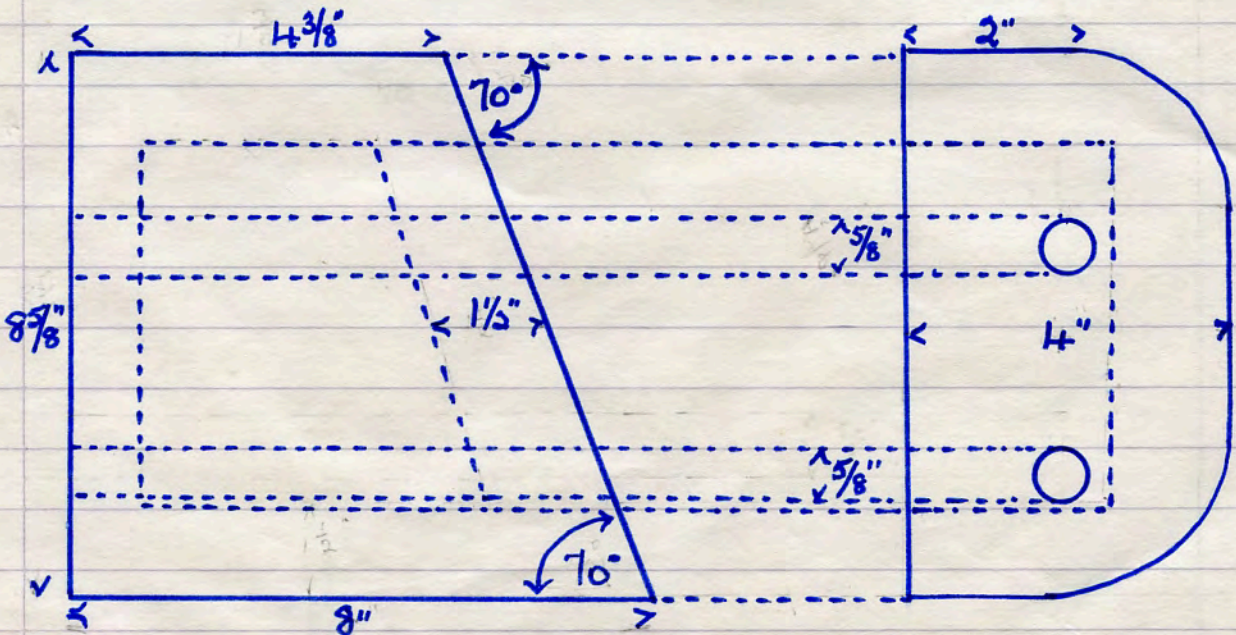

Acception Moai dem. site 2. 2. '89

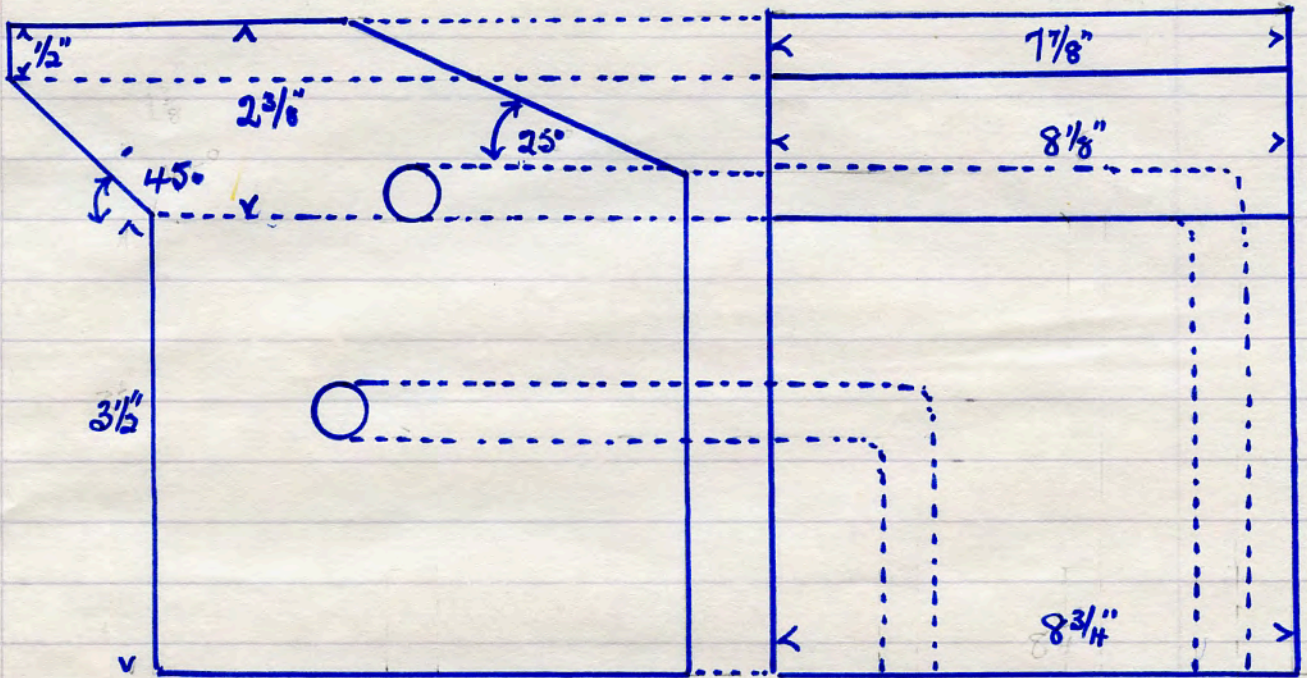

No name 862 Y red T.C 21 lbs.

4258

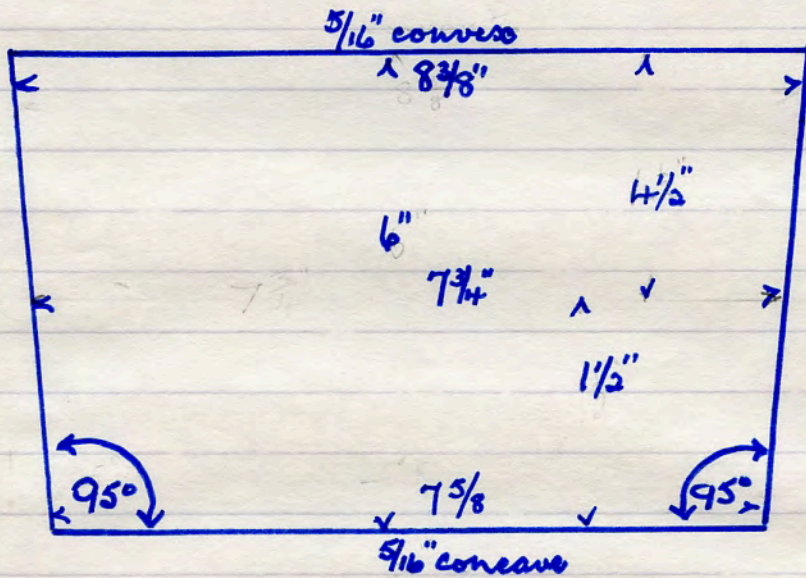

Acc/ton Mori dem. site 2. 2. '89
ENFIELD C^o LTD ACCRINGTON stamped in oval.

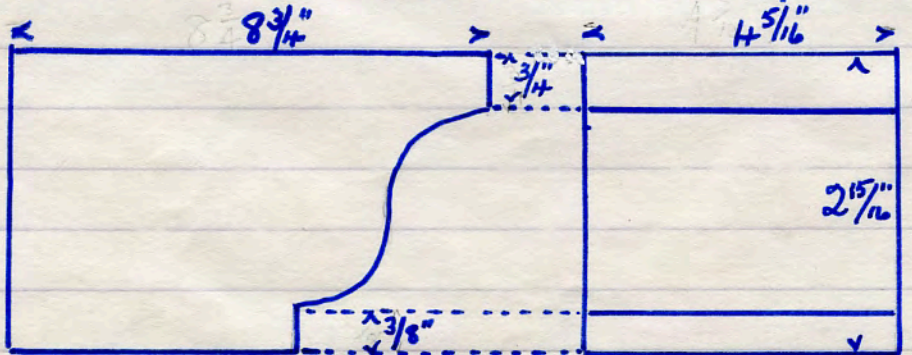

red T.C.
9 lbs.

4259

Number 51 in Enfield catalogue.
Acc/ton Mori dem. site 3. 2. '89

4260

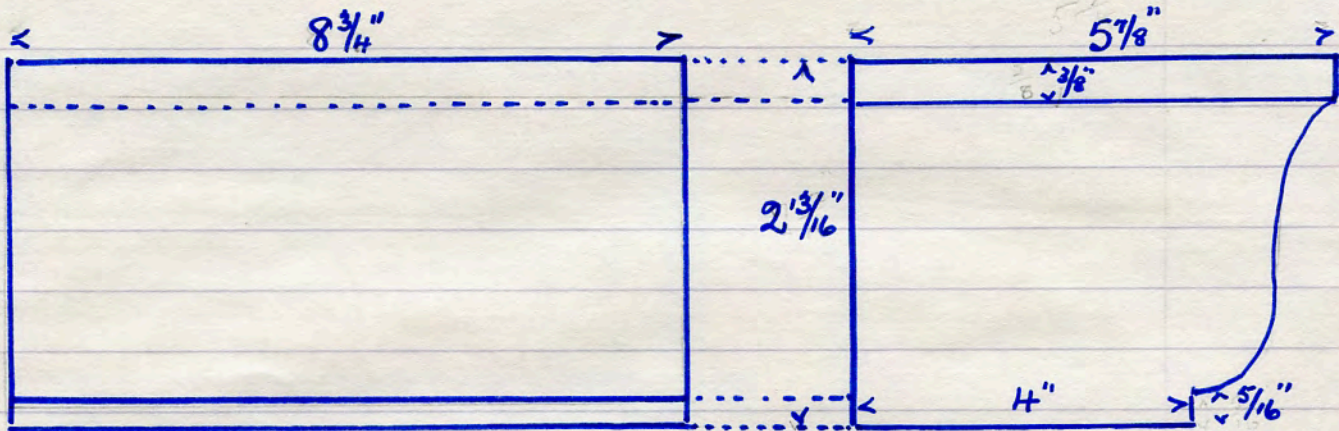

ENFIELD CO LTD ACCRINGTON stamped in oval. red T.C.
 No 8 in Enfield catalogue. 11 lbs 6 cms

4261 22.5 cms

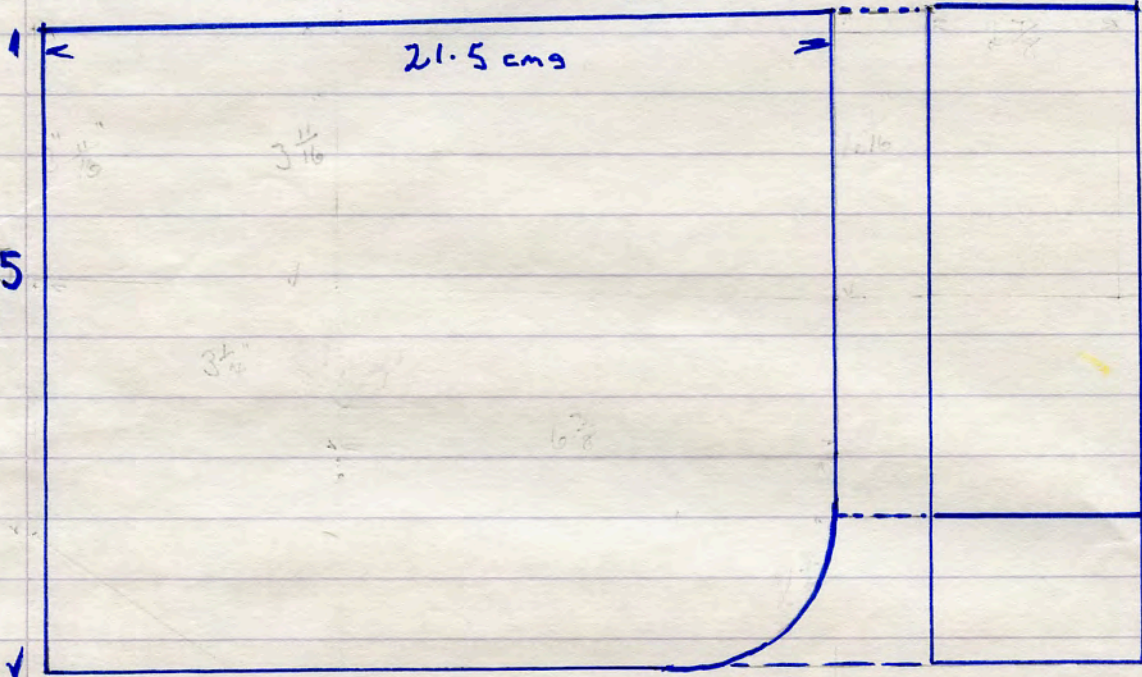

No name 147 T2 dark brown 9 lbs

4262

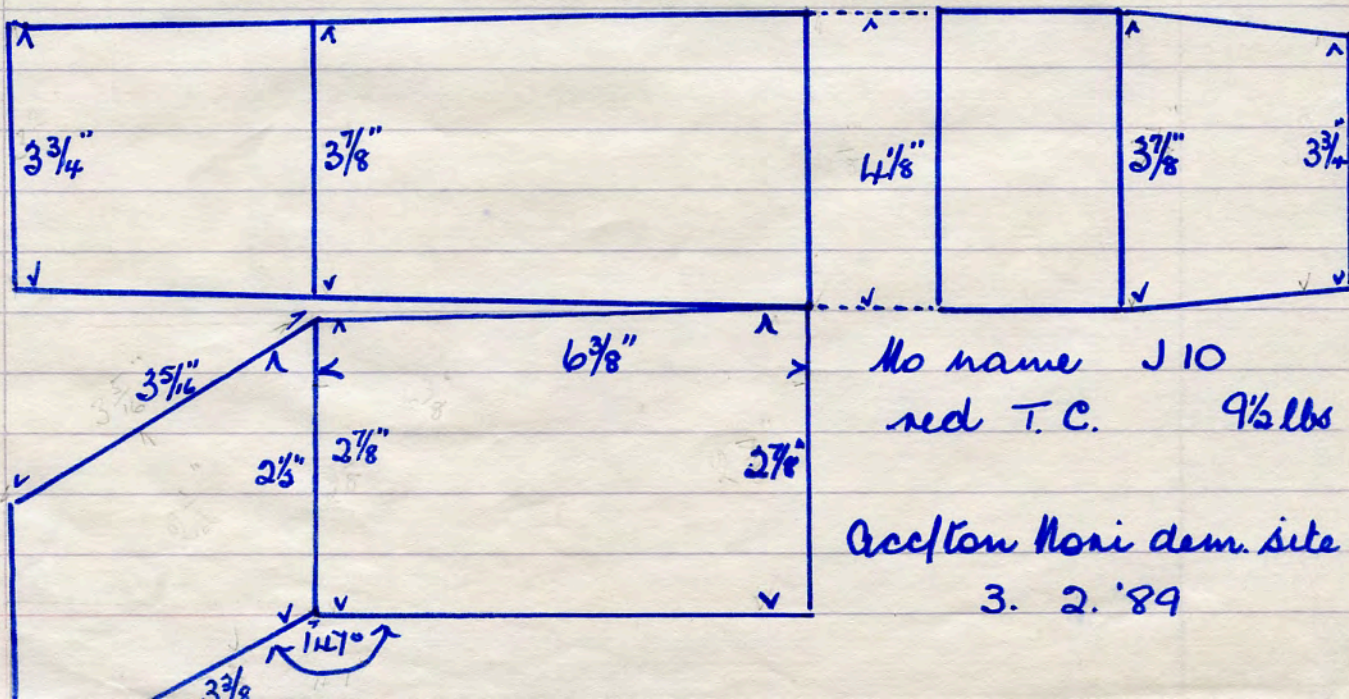

No name J10
 red T.C. 9 1/2 lbs
 Acc/ton Noni dem. site
 3. 2. '89

4263.

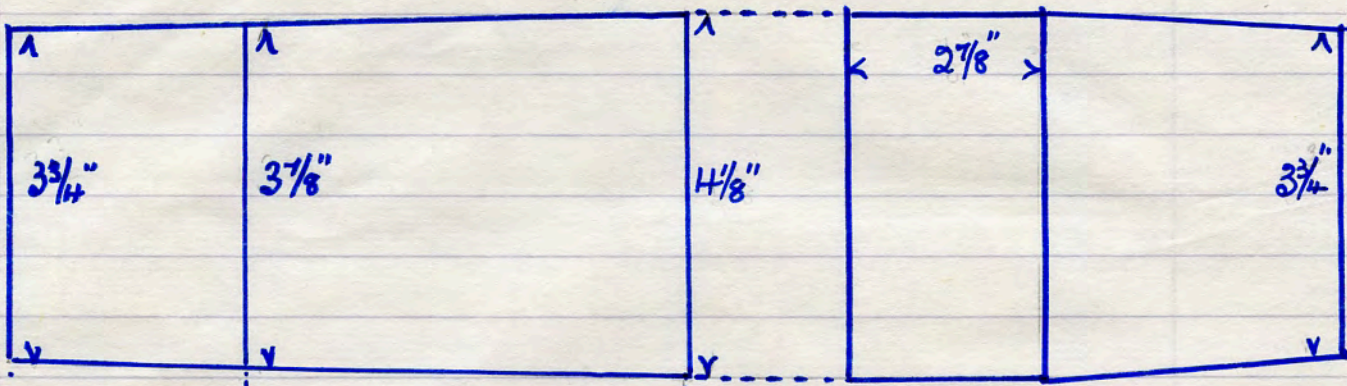

No name J 12
red T. C. 9 1/2 lbs.

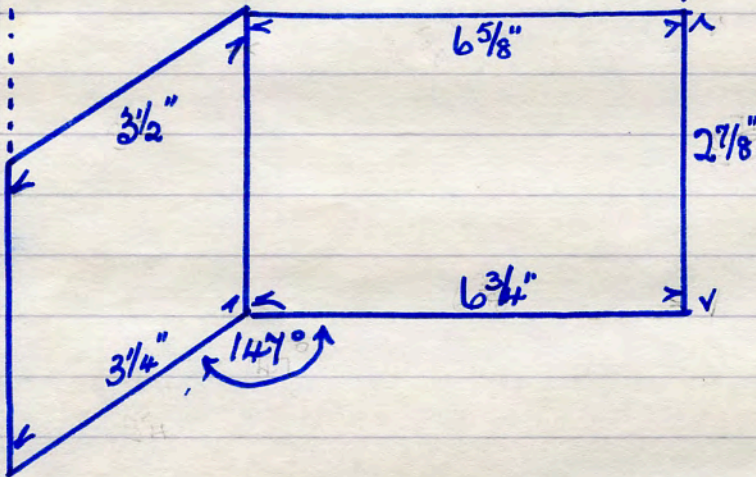

4264

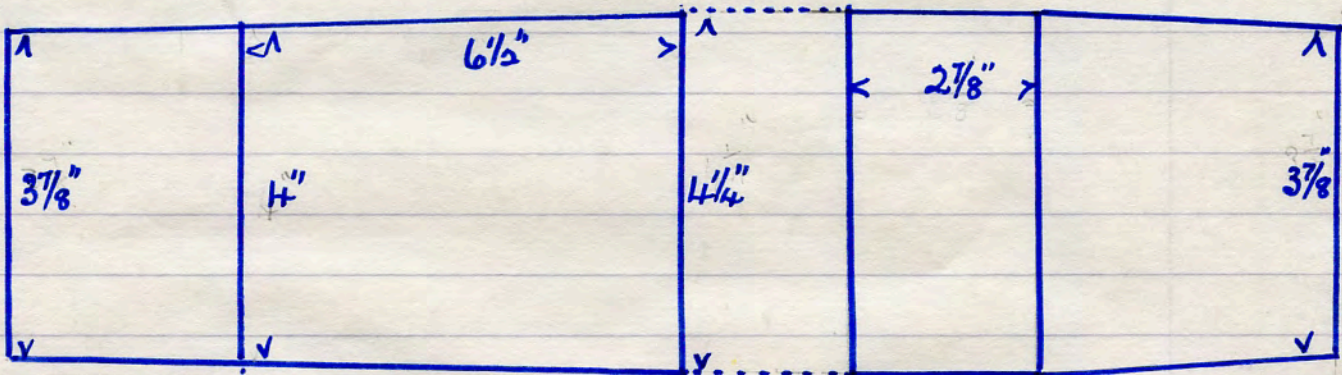

No name J 14
red T. C. 10 lbs.

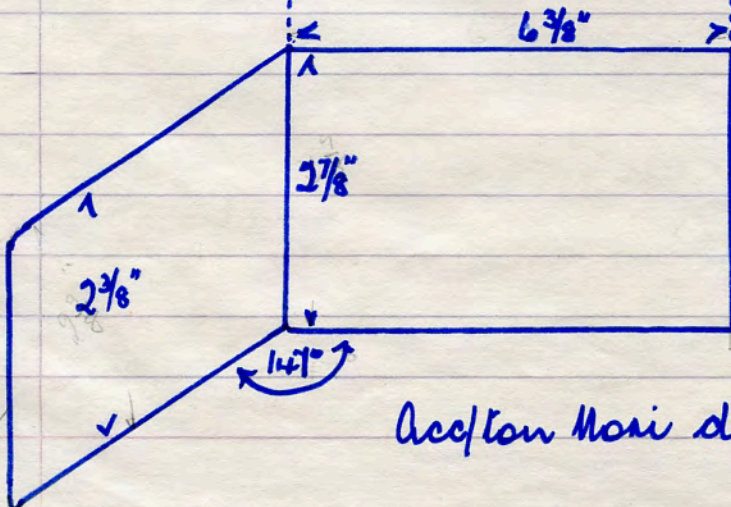

Acclton Mori dem. site 3. 2. '89

4265

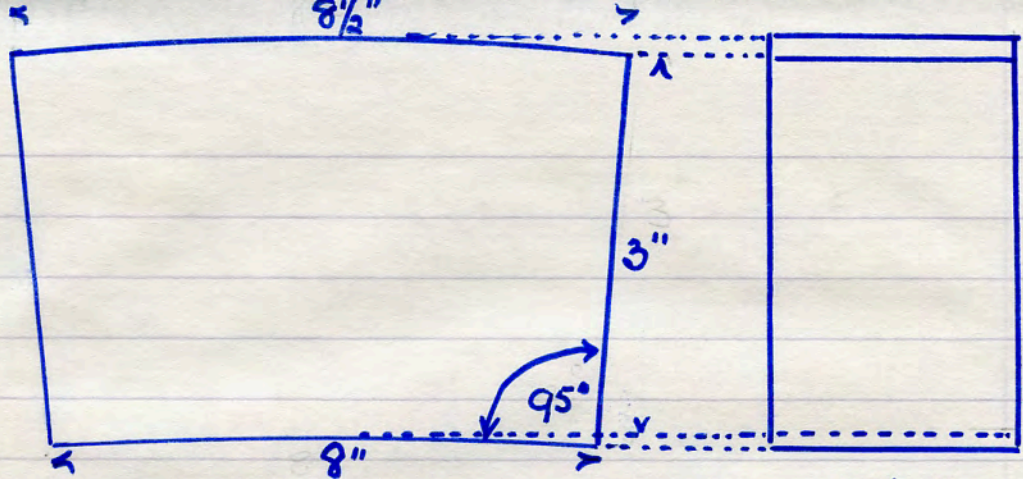

No name 75 K 14 red T.C. 8 3/4 lbs

4266

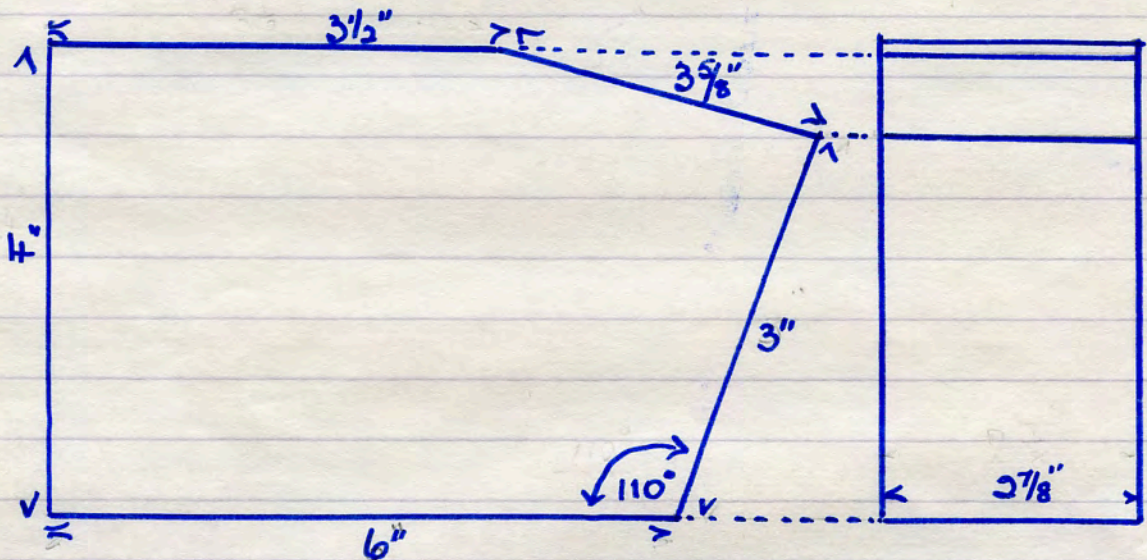

No name 216 T2 red T.C. 6 lbs.

4267

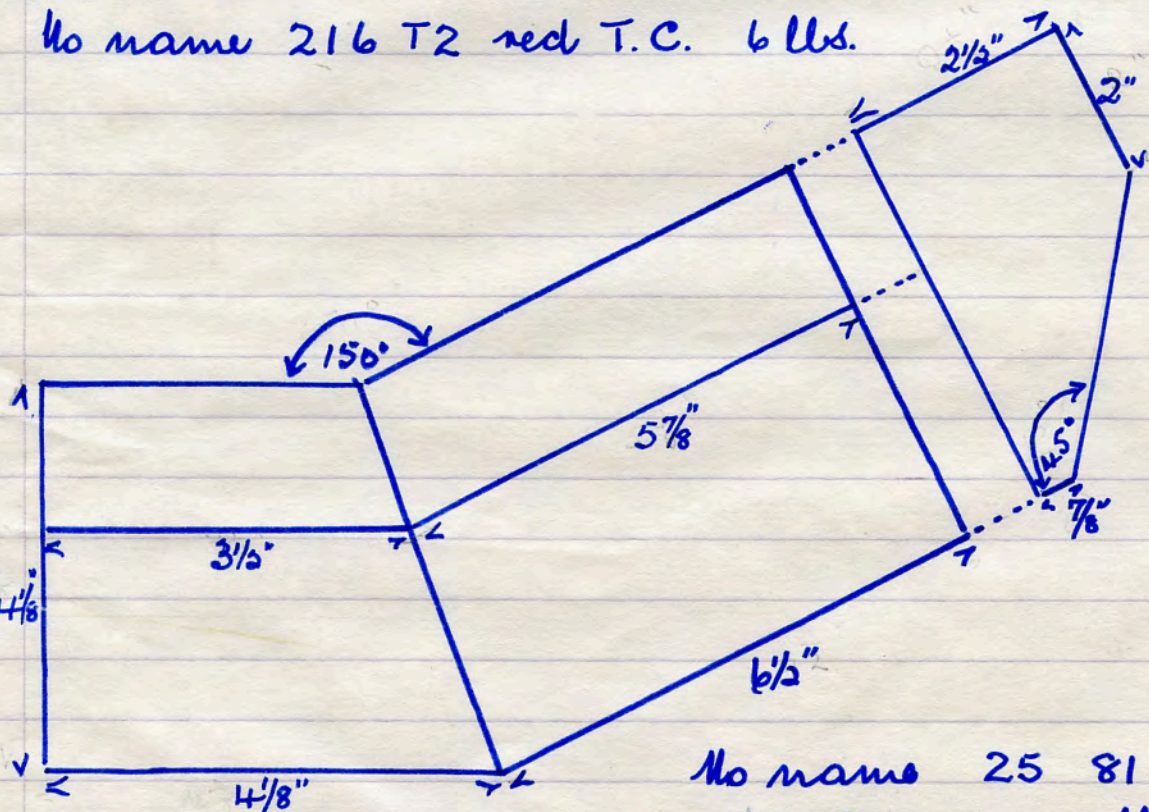

No name 25 81 L
red T.C. 7 lbs

Acpton Nori dem. site 3. 2. '89

No name 32 RG red T.C. 13 Uds.

H268

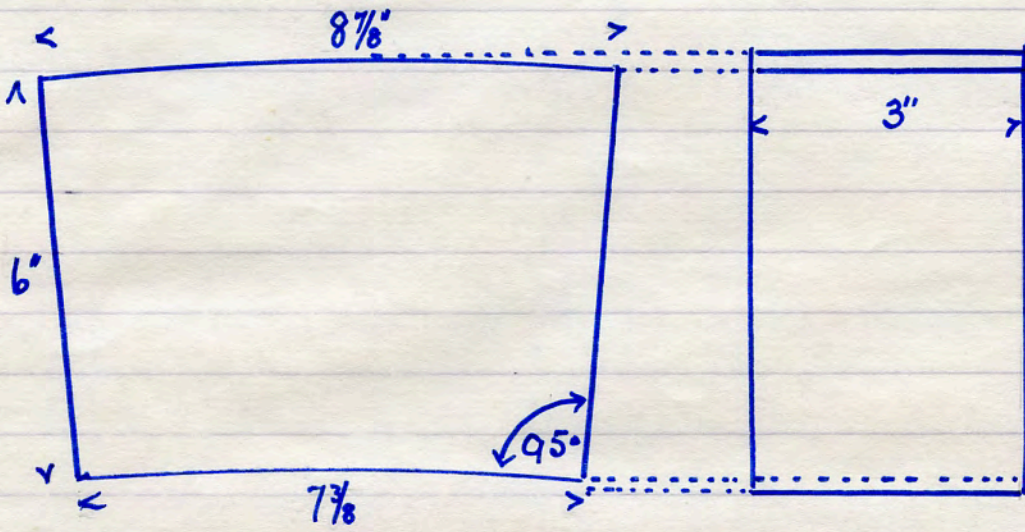

No name PE 2.
red T.C. 24 lbs

H269

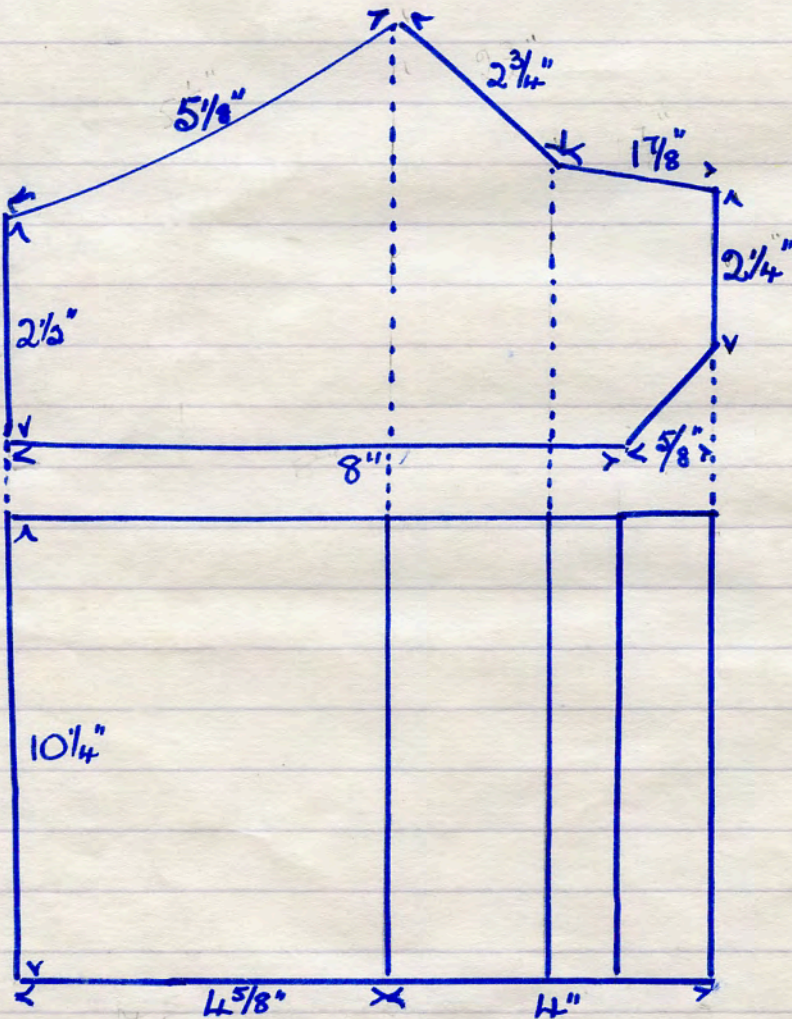

Acc/ten Moni dem. site 3. 2. '89

4270

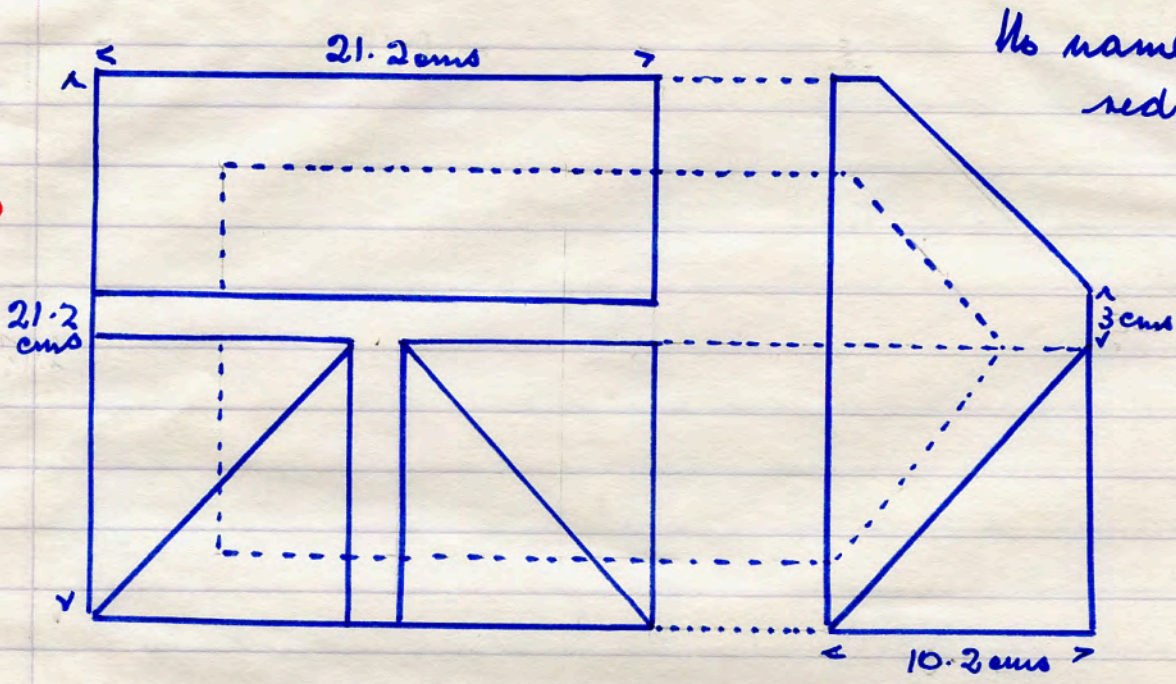

No name 815 v D
red T.C.
14 lbs

4271

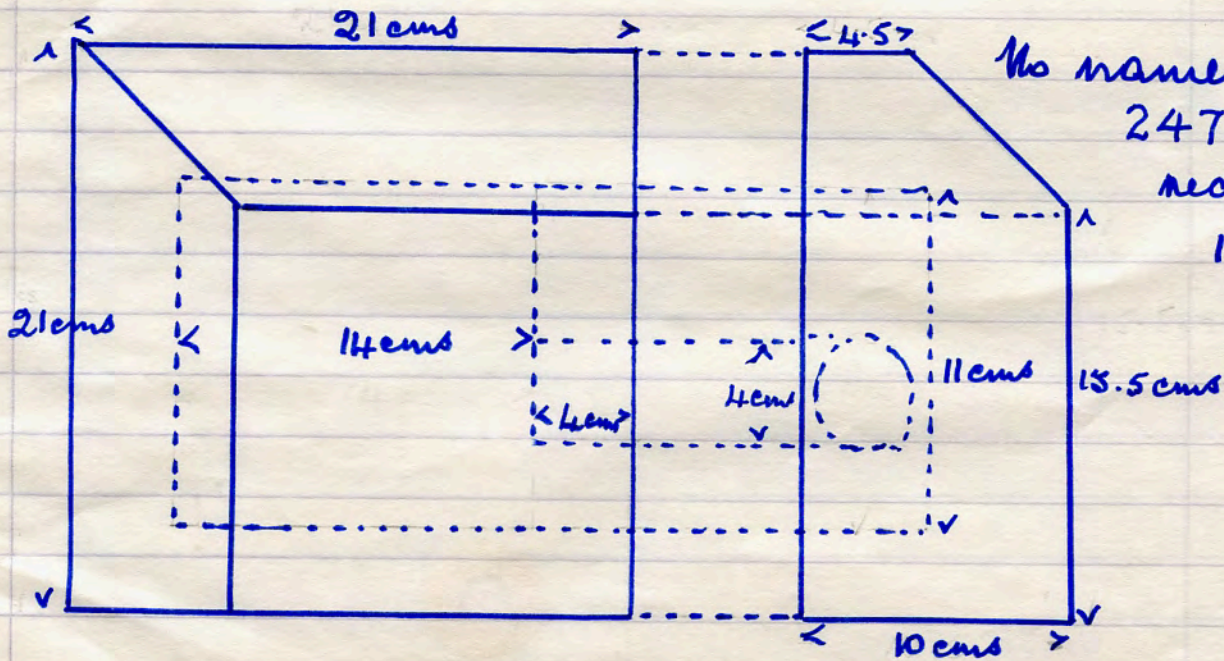

No name
2471
red T.C.
16 lbs

4272

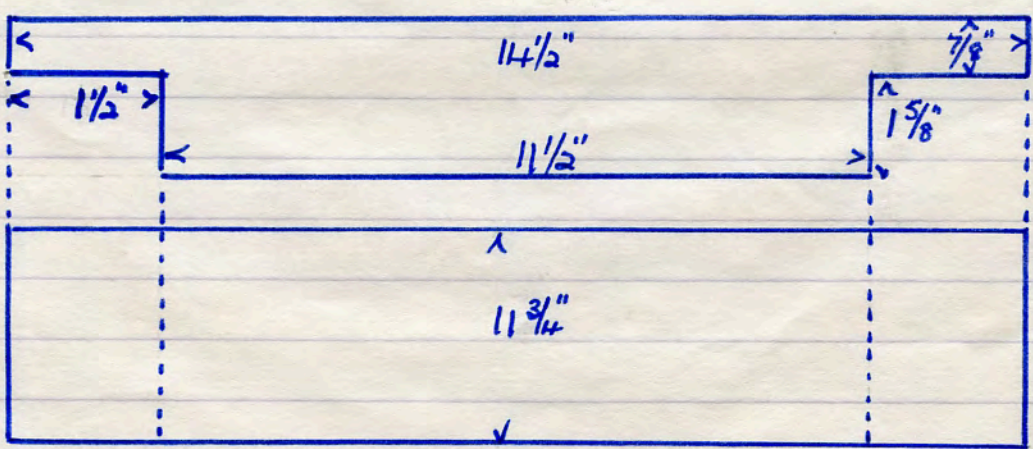

No name
242 U
red T.C.
31 lbs.
31 moulder's
mark

Occupation Moni dem. site. 6. 2. '89

4273

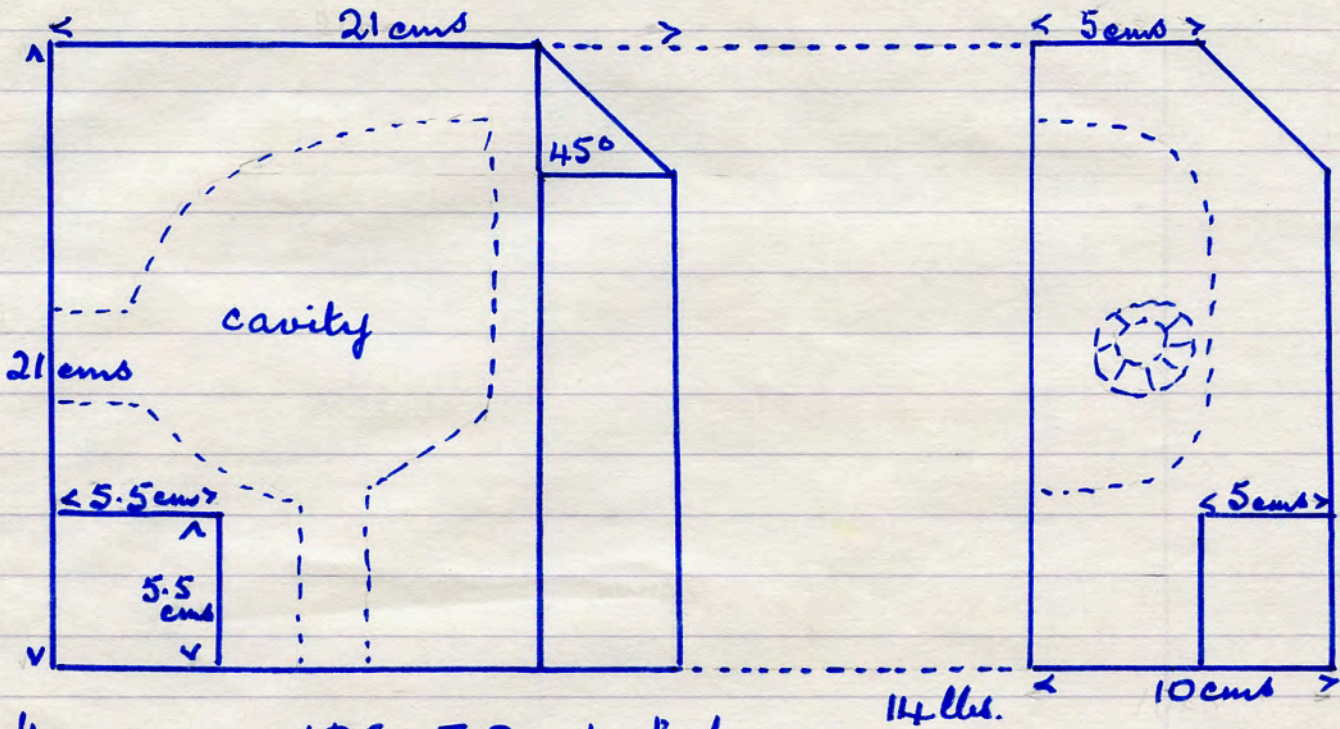

No name 125 T2 dark brown

4274

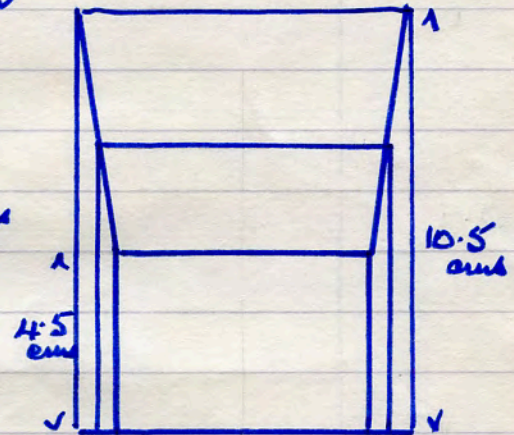
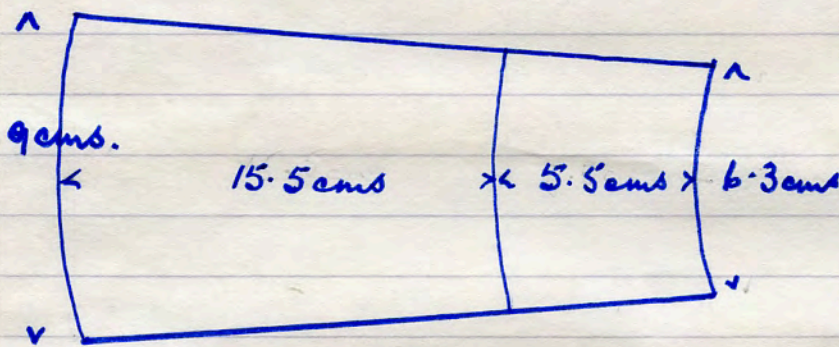

No name 234 TA
red T.C. 8 lbs

4275

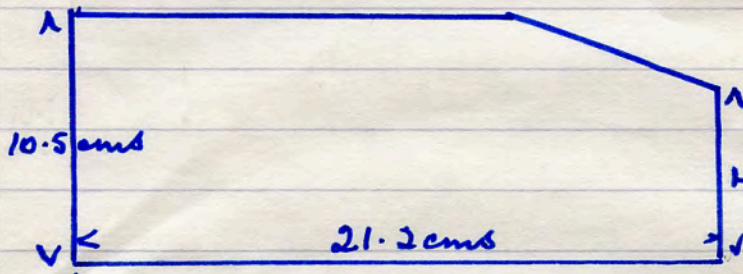

No name
5 R 43
red T.C.
2 lbs.

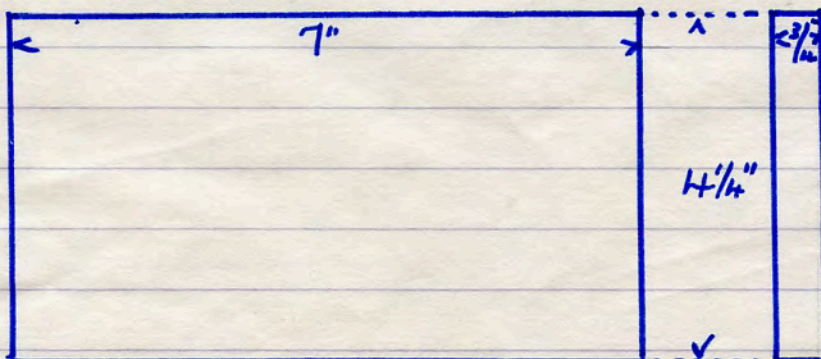

Ascp on Mori dem. site 6. 2. '89 + 7. 2. '89

H276

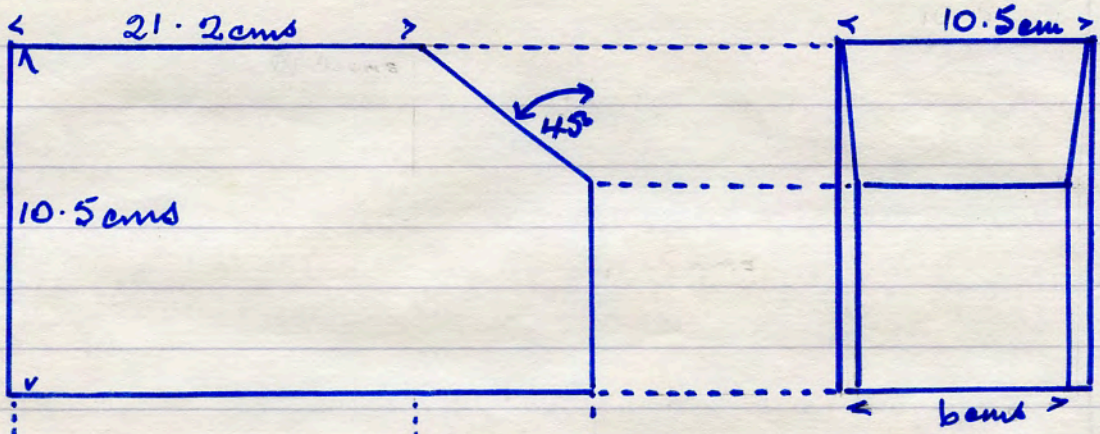

No name 234 TB
red T.C. 9 lbs

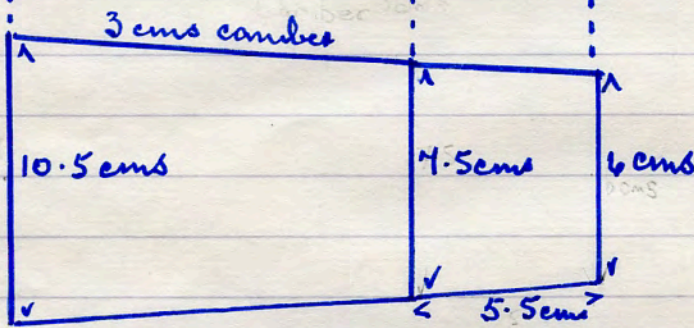

H277

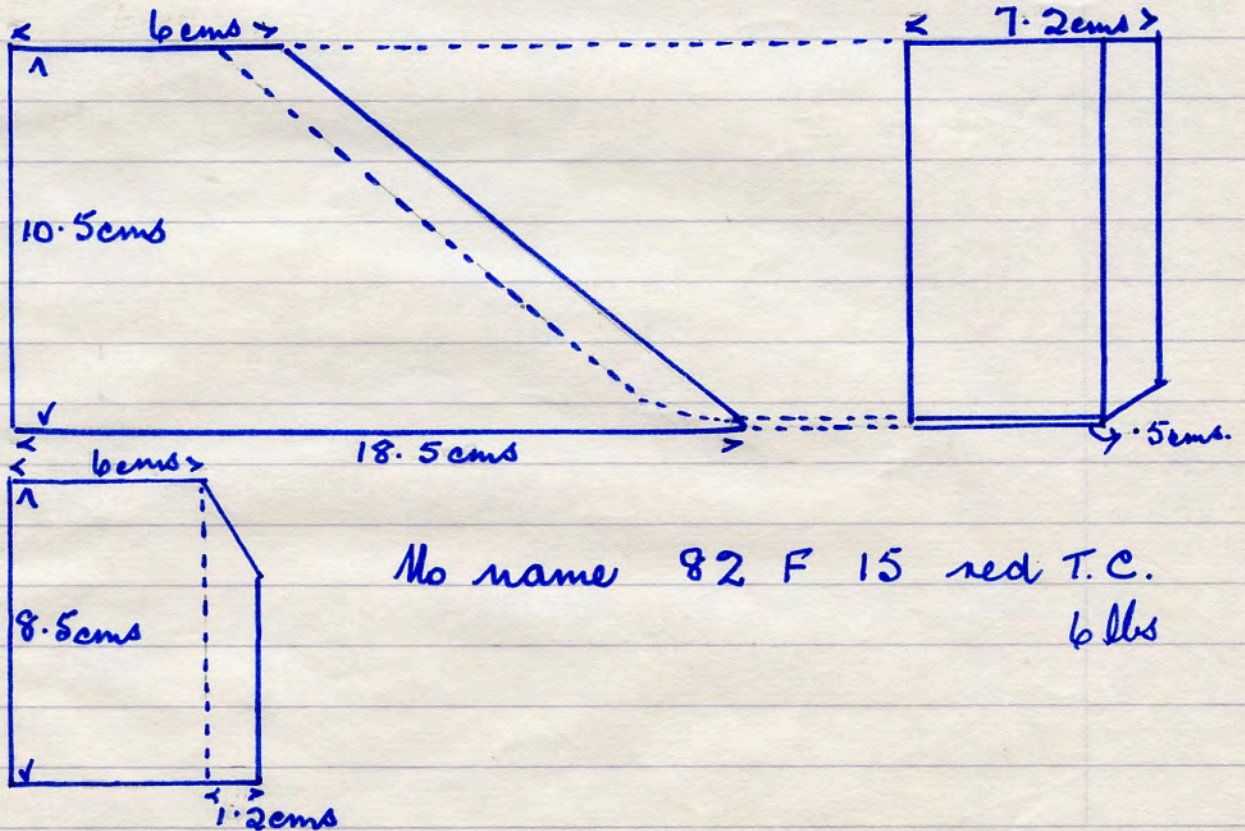

No name 82 F 15 red T.C.
6 lbs

Acfton Nari dem. site 6. 2. '89 + 7. 2. '89

4278

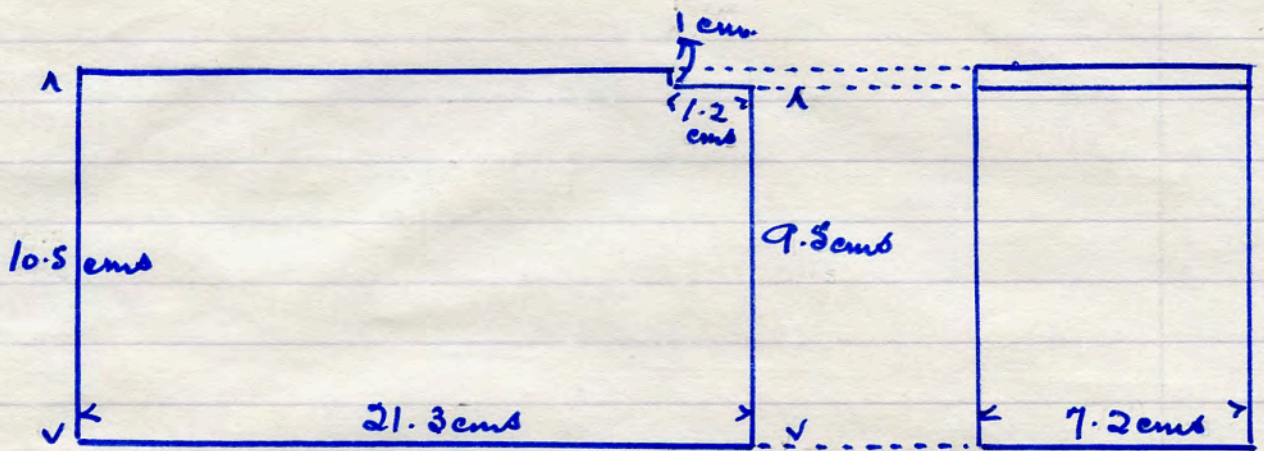

No name 45 C 6 red T.C. 9 lbs

4279

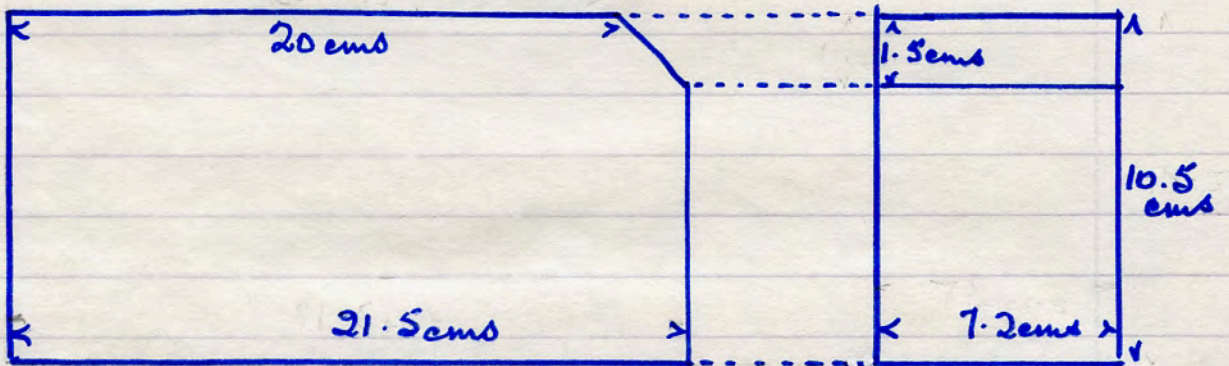

No name 93 L 2 red T.C. 9 lbs

4280

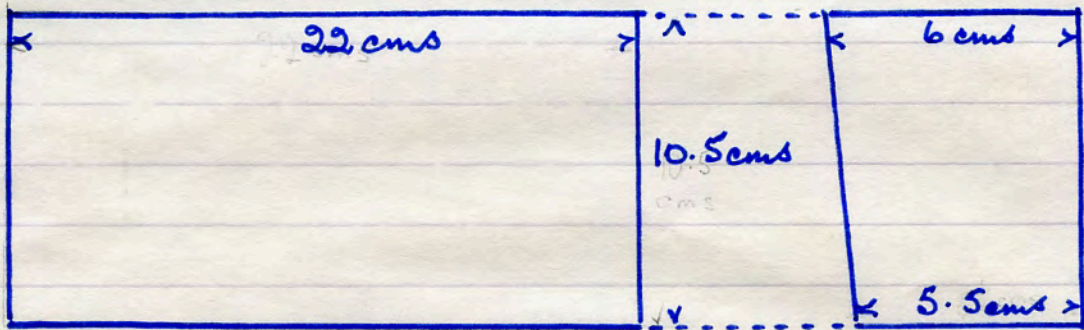

No name 57 E red T.C. 7 lbs.

4281

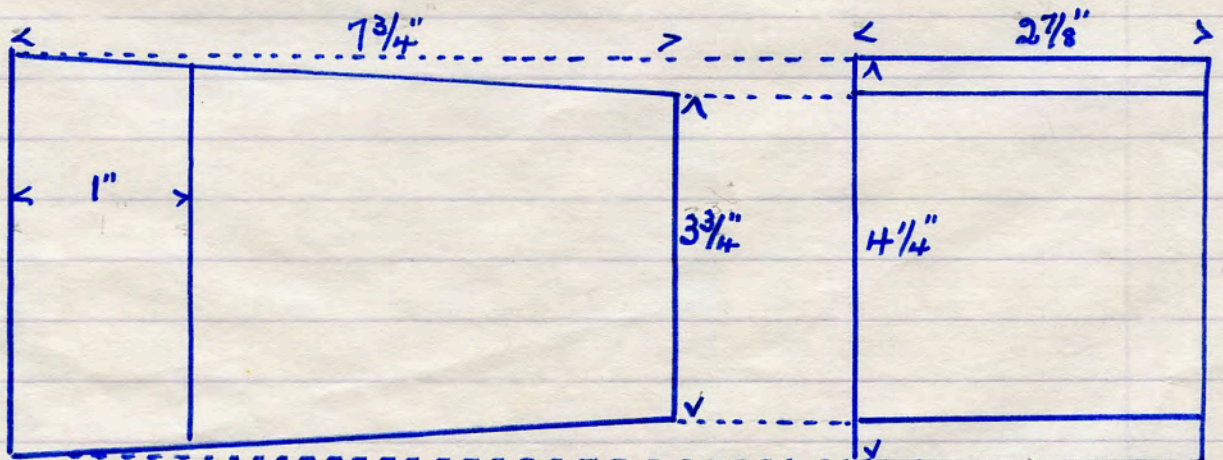

No name 75 NI red T.C. 7 1/2 lbs.

Acceptor Hosi dem. site 5th, 6th, 7th & 10th Feb. 1989

No name. 53 Q.M. red T.C. 8 lbs.

4282

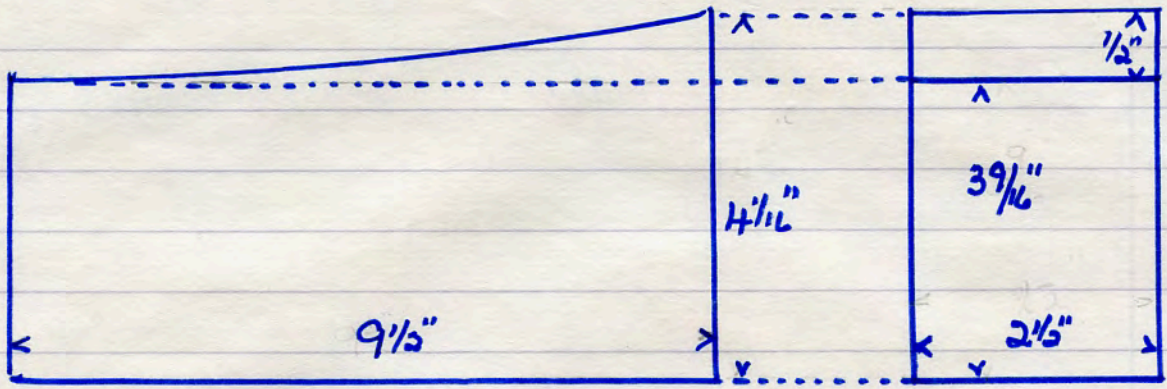

4283

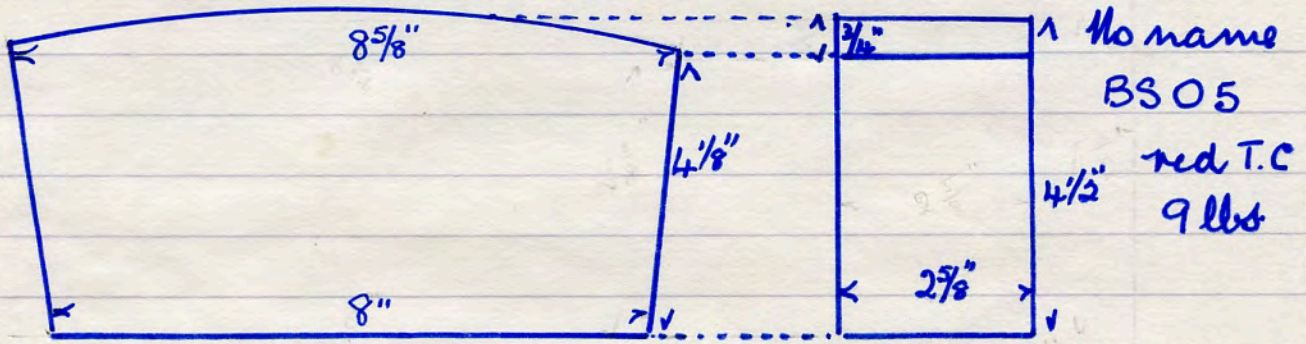

No name
BS05
red T.C.
9 lbs

4284

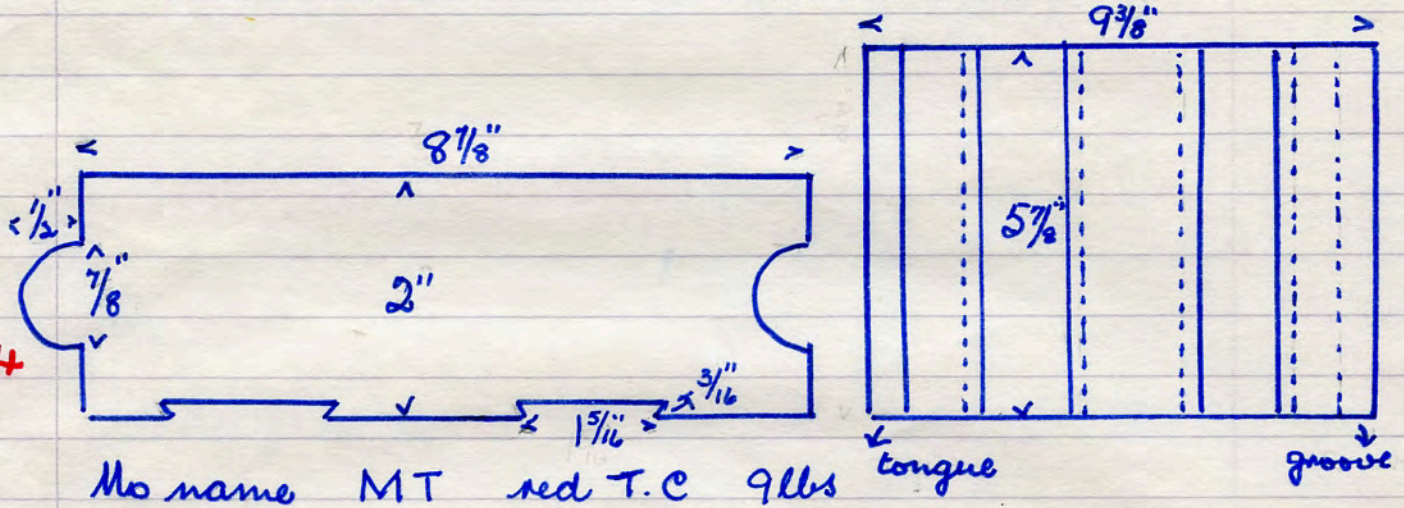

No name MT red T.C 9 lbs

No name 62 Q.11 red T.C. 10 lbs.

4285

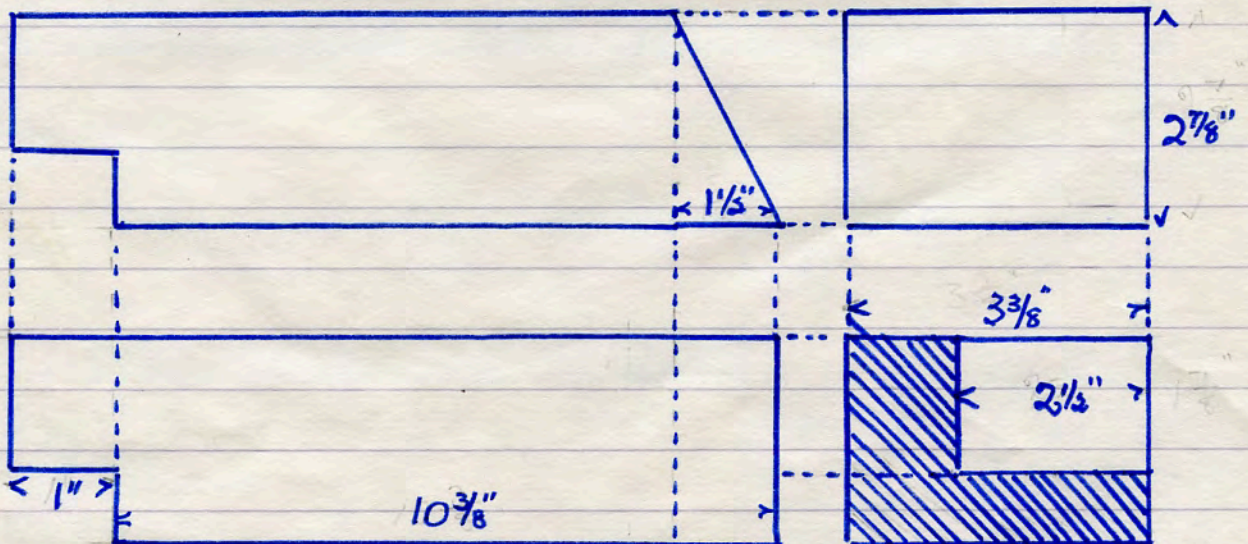

Acceptor Mori dem. site 10. 2. '89.

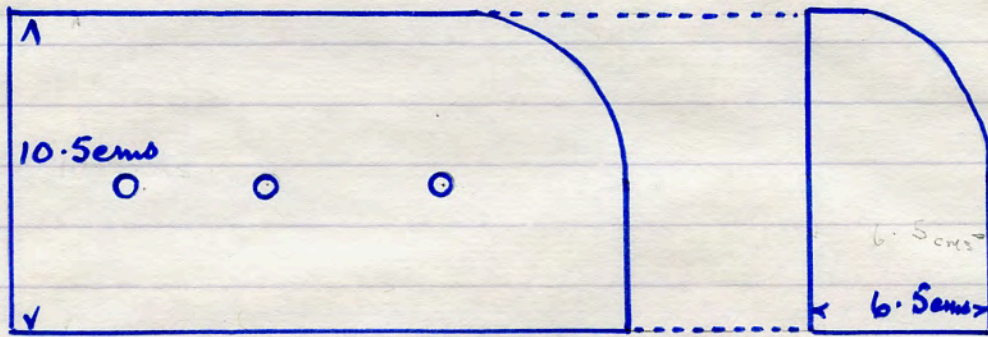

4286

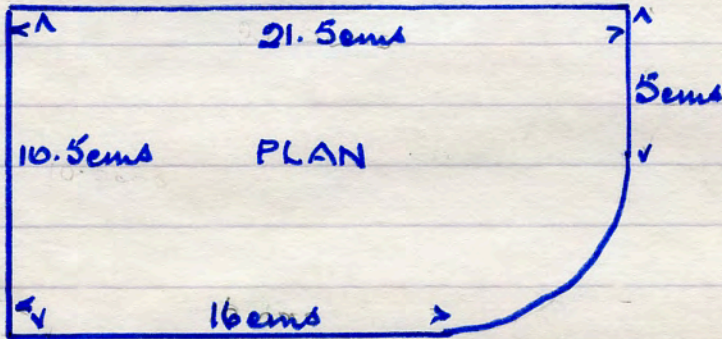

No name 23102 LD
dark brown blk.
7 lbs.

4287

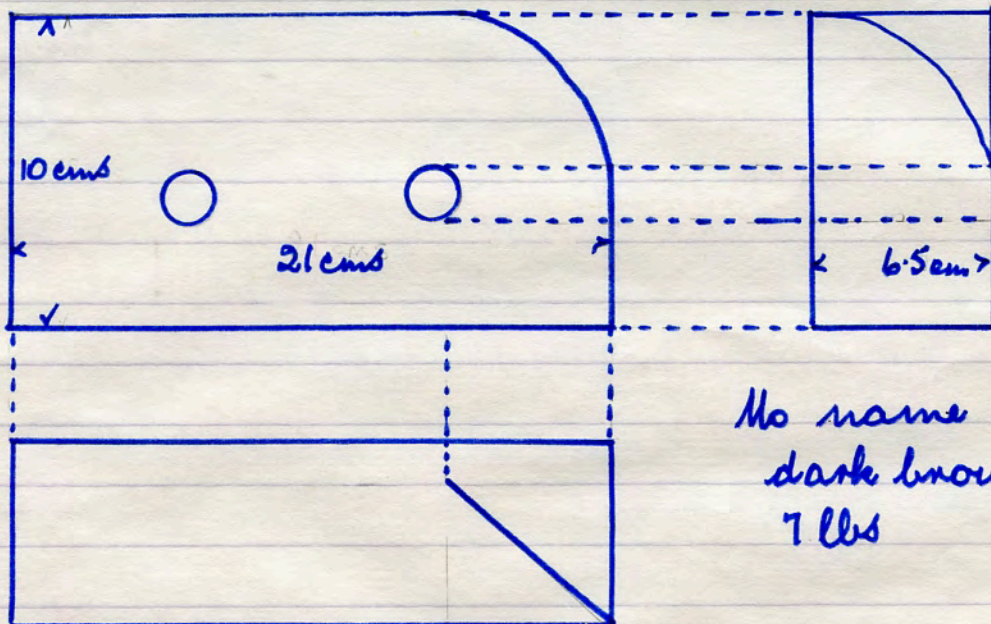

No name 2372 RD
dark brown blk
7 lbs

Acfton Maxi dem. site. 10. 2. '89

4288

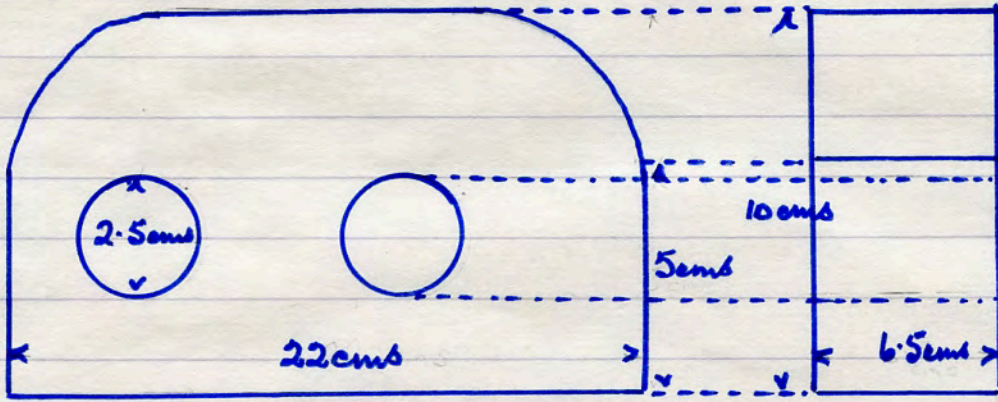

No name
 232 2C
 dark brown
 brk.
 7 lbs.

4289

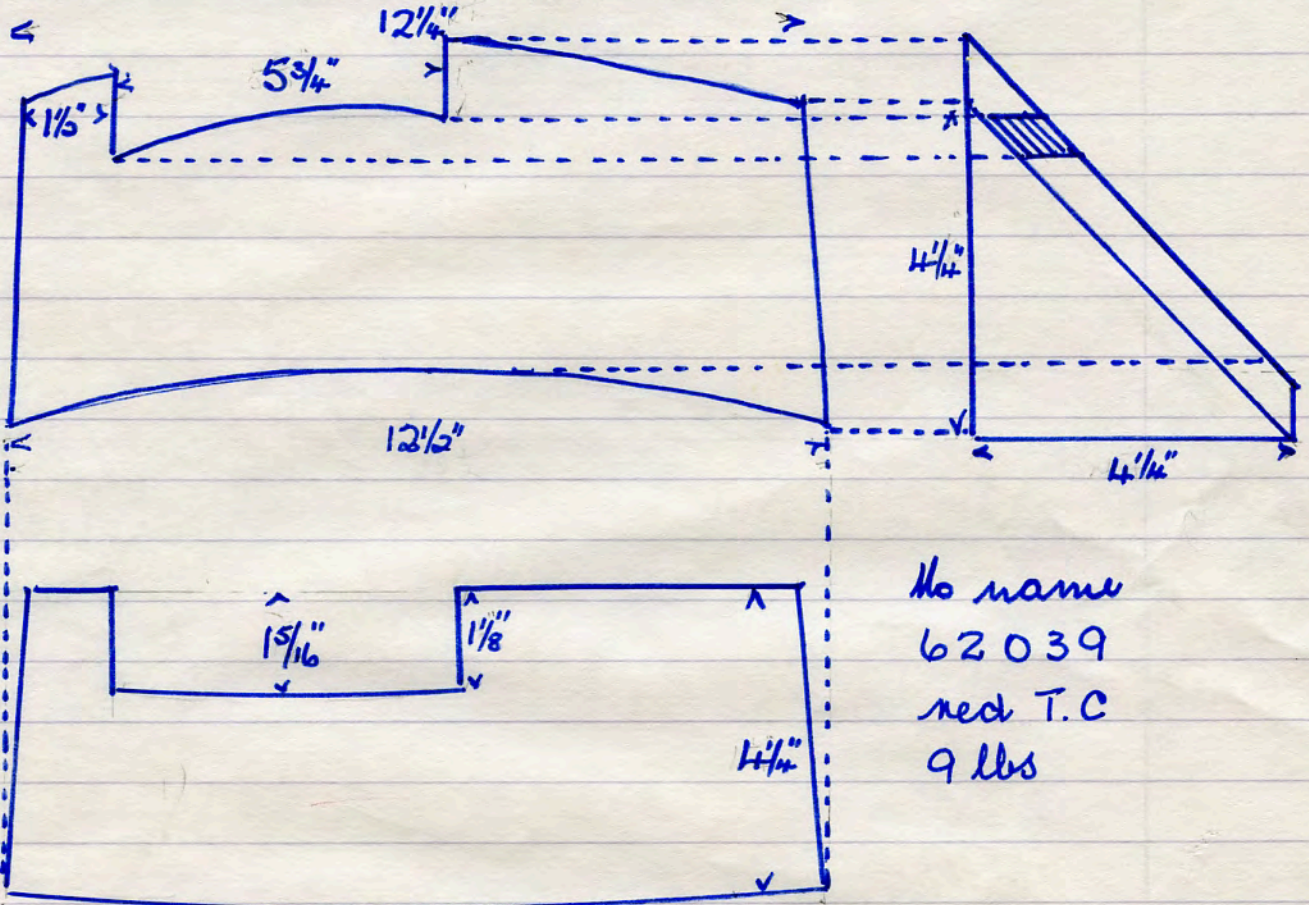

No name
 62039
 red T.C
 9 lbs

No name 224 T1 red T.C. 5 lbs

4290

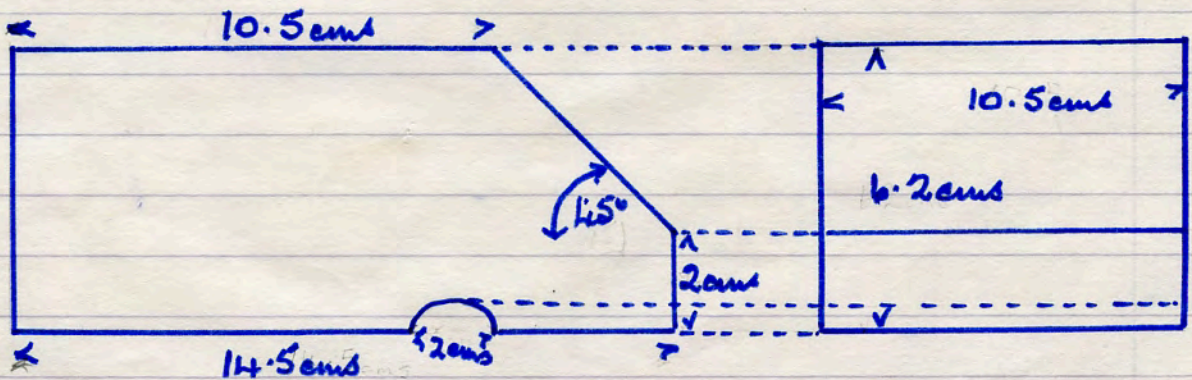

Accepton Masi dem. site 9. 2. '89 + 10. 2. '89

4291

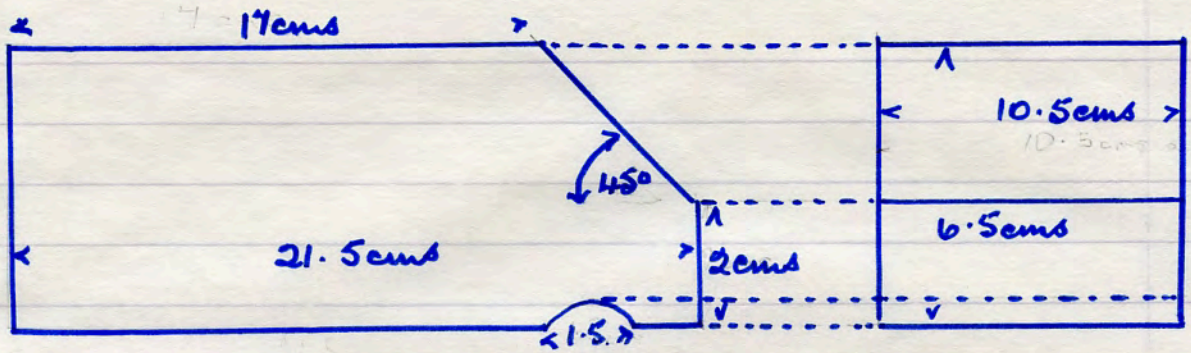

No name 308 T1 red T.C 7 lbs.

4292

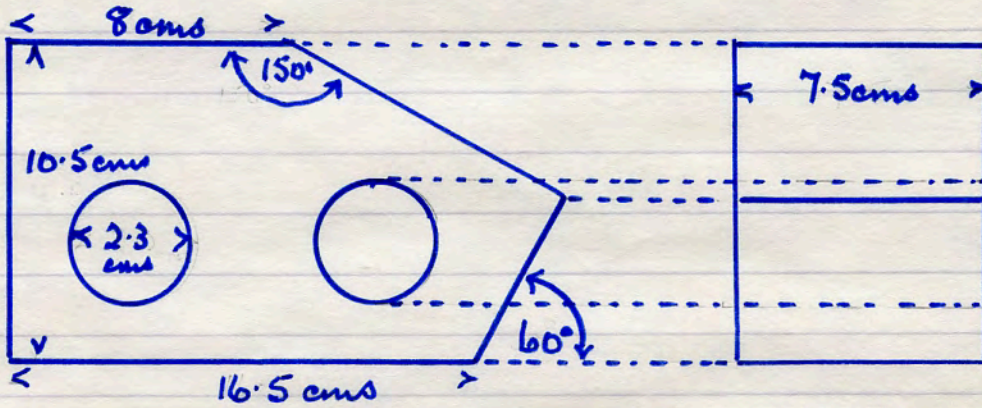

No name 60-7 red brk 6 1/2 lbs

4293

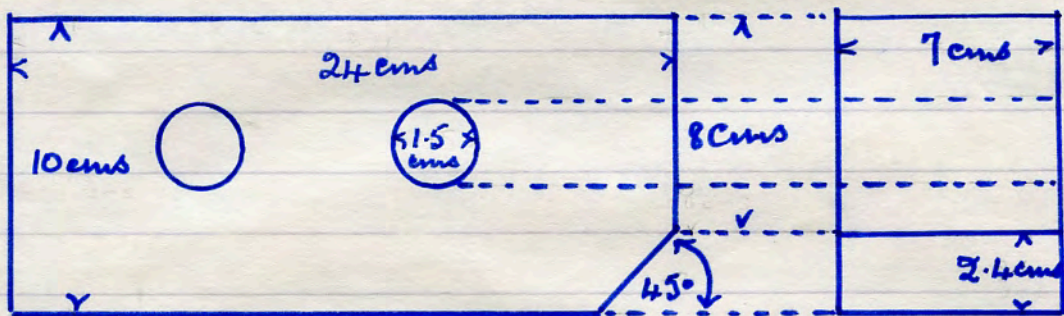

No name 289 V5 red brk 8 lbs

4294

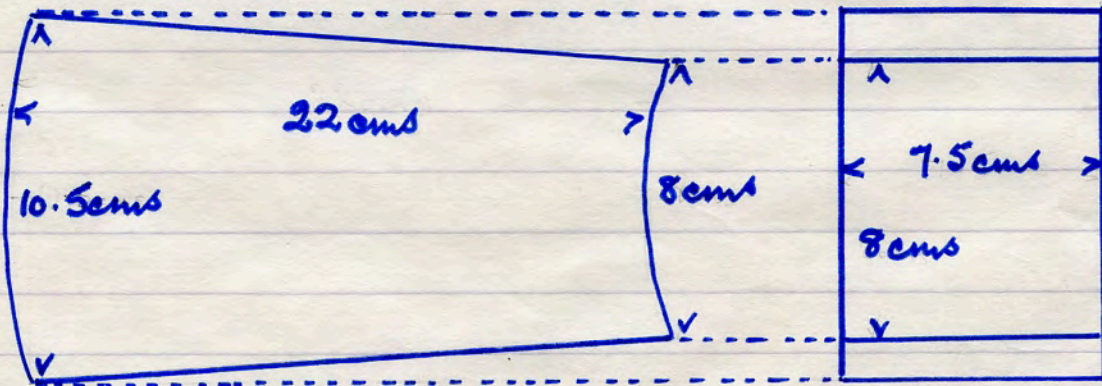

No name DHO red brk 8 lbs.

Gepton Mori dem. site 9. 2. '89

4295

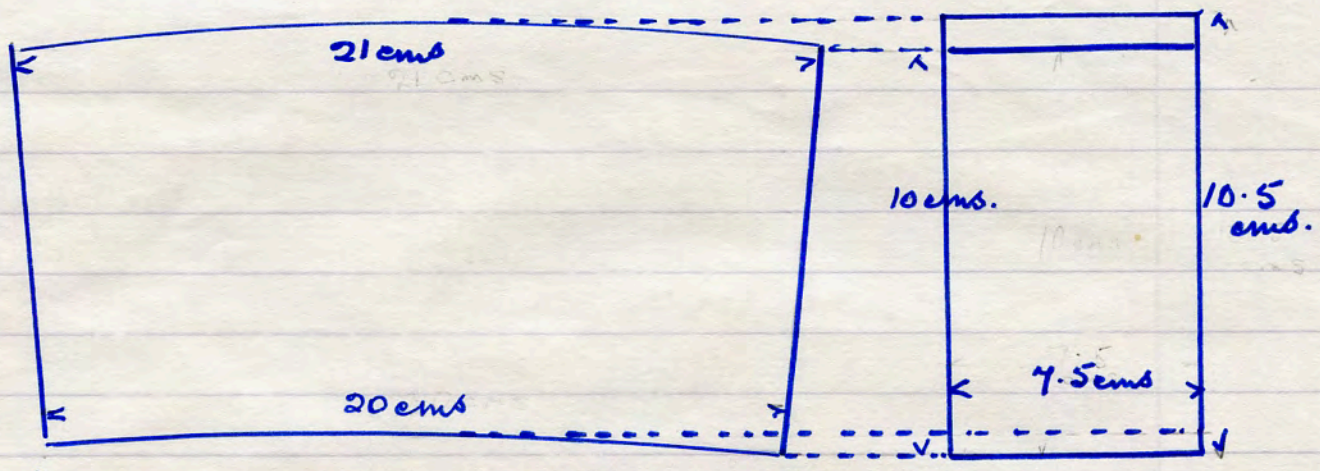

No name C50 red brk. 8 lbs

4296

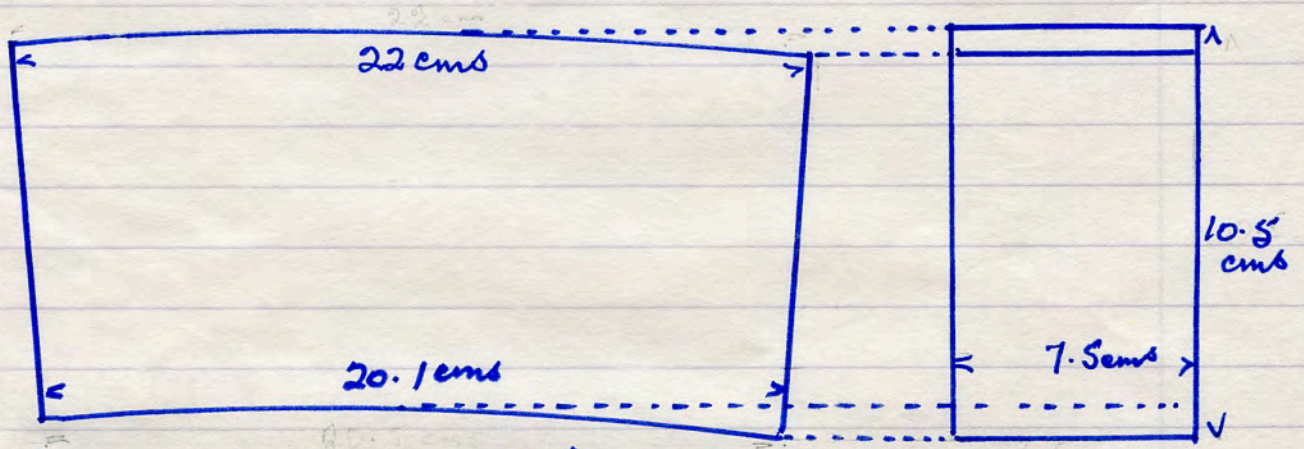

No name B red brk 9 lbs

4297

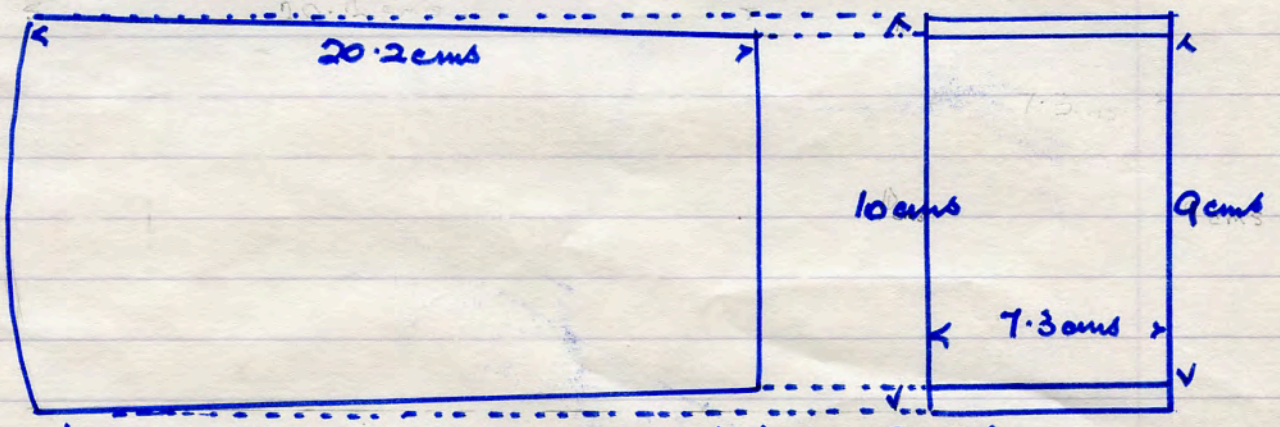

No name HHO red brk 8 1/2 lbs

4298

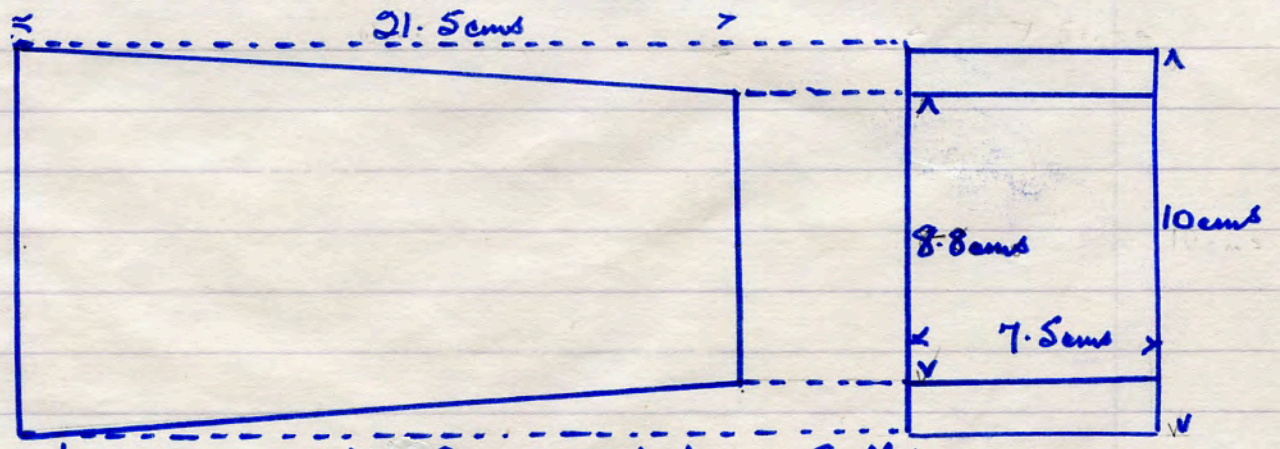

No name H 8 red brk. 9 lbs.

Accepton Mori dem. site 9. 2. '89

4299

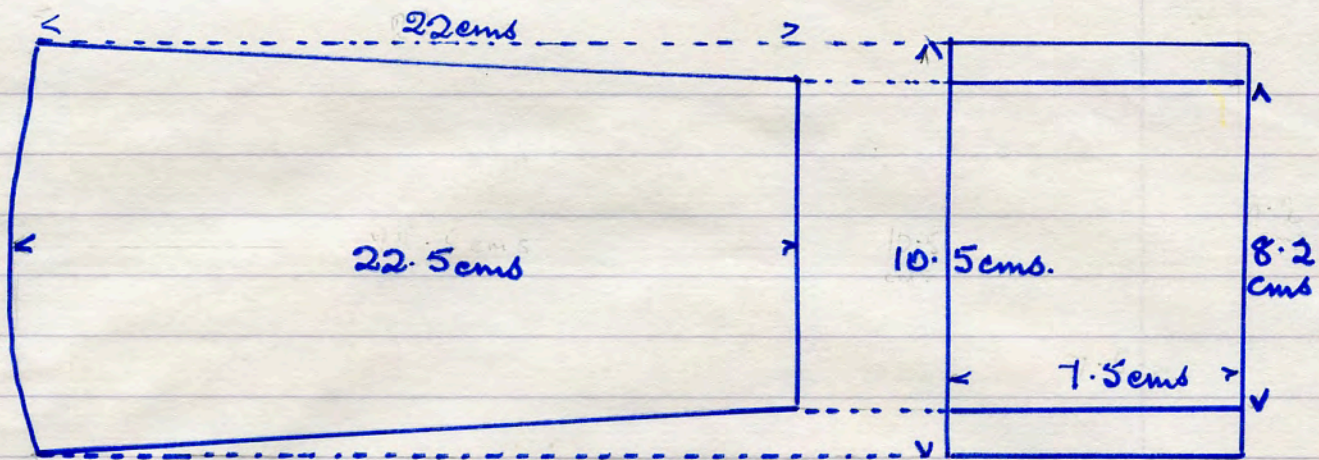

No name C H O red blk 8 1/2 lbs

4300

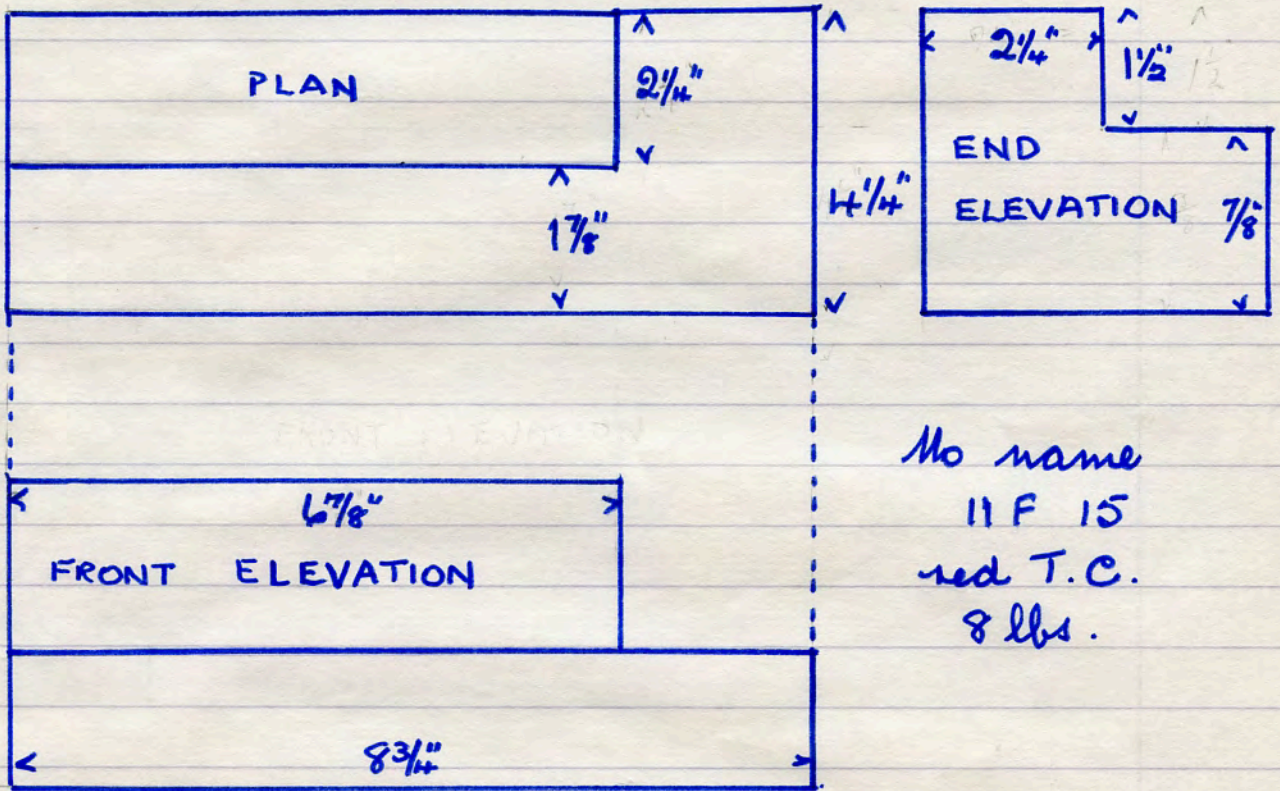

No name
11 F 15
red T.C.
8 lbs.

4301

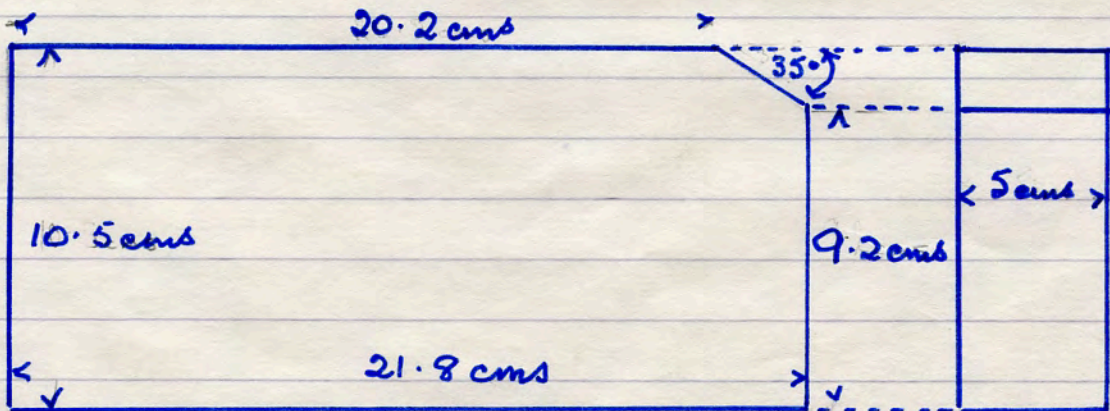

No name F B B 10 red T.C. 6 1/2 lbs
Ocepton Nori dem. site Y. 2. '89 T 9. 2. '89

4302

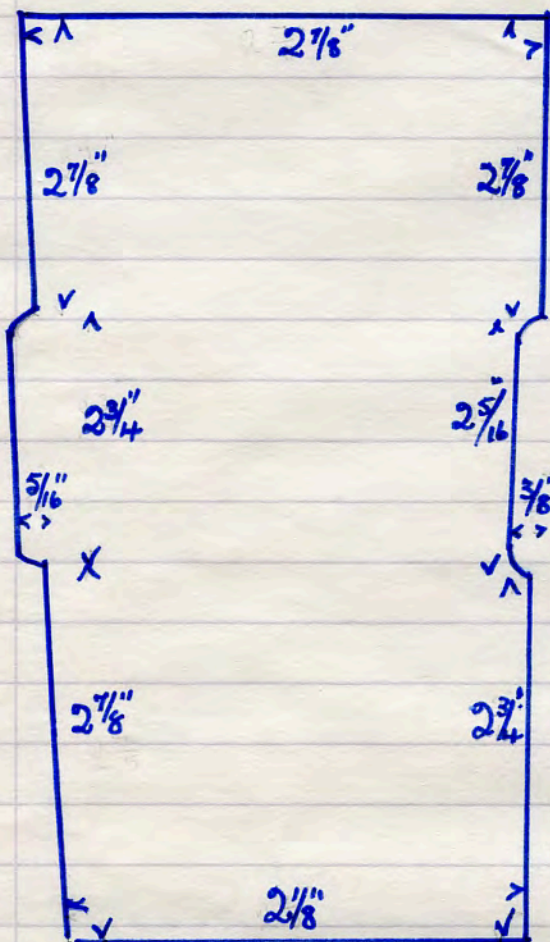

4303

4304

① No name.

Red T.C segment to form circle 2' 3" diam.

Moulder's mark. JI 14 lbs.

Top width 3" base 1 7/8"

② No name

Red T.C. segment to form circle 2' 6" diam.

Moulder's mark HB. 14 lbs

Similar in shape to No 1.

Top width 2 3/4". base 1 3/4"

③ No name.

Red T.C segment to form circle 2' 9" diam.

Moulder's mark HB. 15 lbs.

Similar in shape to Nos. 1 & 2.

Top width 2 7/8". base 2"

④ No name

Red T.C segment to form circle 4' 9" diam

Moulder's mark JI 16 lbs.

Similar in shape to No. 1. etc.

4305

Top width 3". base 2 5/16"

4306

⑤ No name. Red T.C segment to form circle

5' 0" diam. Moulder's mark JC 15 lbs.

Top width 2 7/8". base 2 1/4"

4307

⑥ No name. Red T.C segment to form circle

5' 3" diam. Moulder's mark JI 16 lbs.

Top width 2 15/16" base 2 5/16"

cont. from No. 4307.

4308

⑦ No name. Red T.C. segment to form circle
3' 6" diam. Moulder's mark HB 14 1/2 lbs.
Top width 2 3/16" base 1 7/8"

4309

⑧ No name. Red T.C. segment to form circle
4' 3" diam. Moulder's mark HB. 16 lbs.
Top width 3" base 2 5/16"

4310

⑨ No name. Red T.C. segment to form circle
3' 9" diam. Moulder's mark JC. 15 1/2 lbs.
Top width 2 5/16". base 2 3/16"

Acfton Mori dem. site 15. 2. '89

4311

⑩ No name. Red T.C. segment to form circle
4' 0" diam. Moulder's mark DW 14 1/2 lbs
Top width 2 7/8" base 2 1/8"

4312

⑪ No name Red T.C. segment to form circle
3' 3" diam. Moulder's mark. HB 16 lbs.
Top width 3" base 2 1/8"

4313

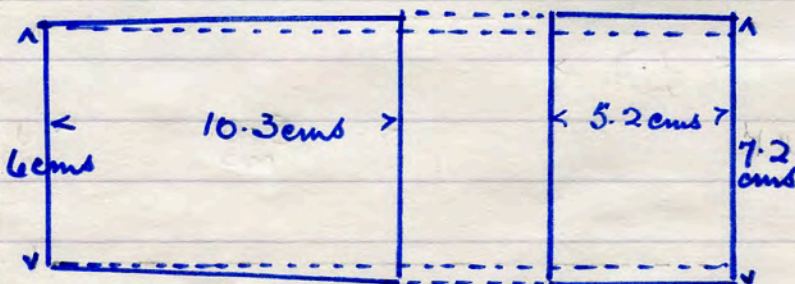

No name 29 P 67
red T.C 2 lbs.

4314

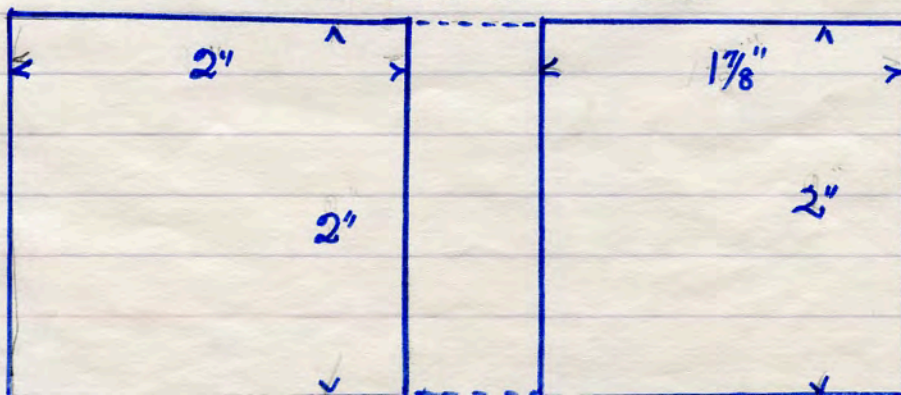

No name 79 F
red T.C 1/2 lb

Acfton Mori
dem. site
14. 2. '89

4315

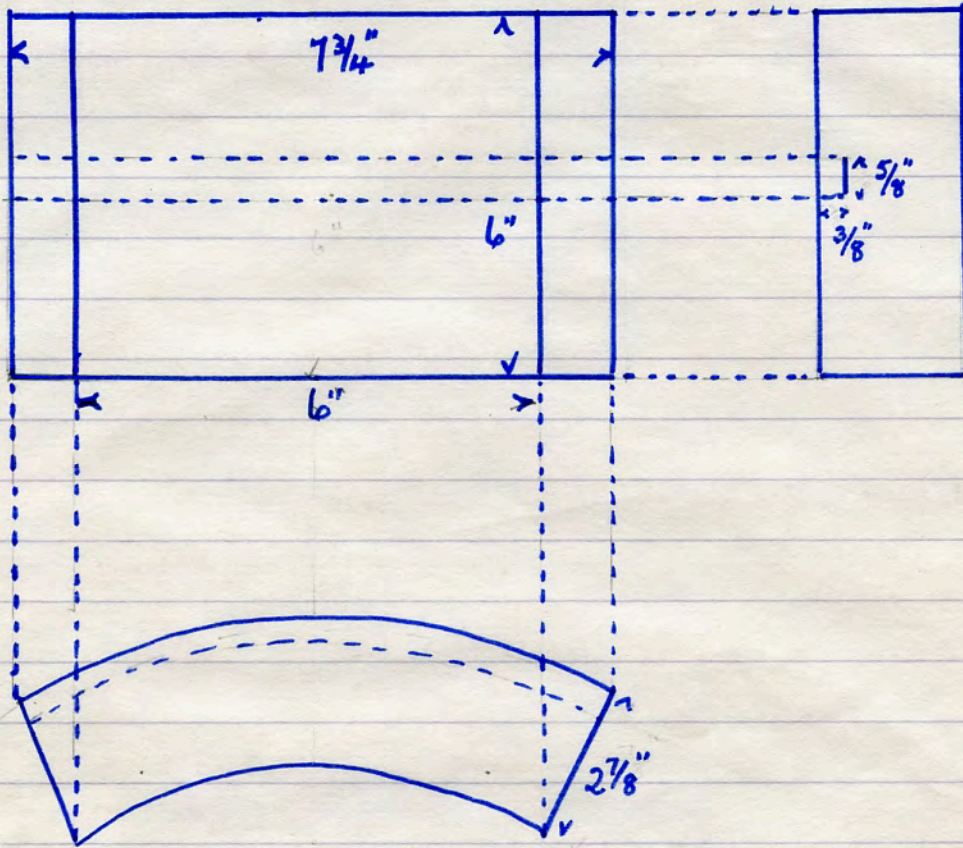

No name
413 Y1
red T.C.
9 1/2 lbs.

4316

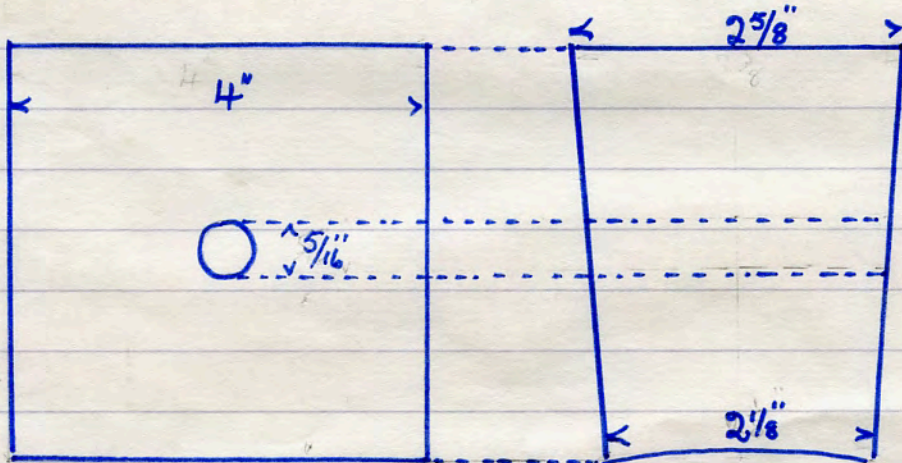

No name
192 TFI
red T.C.
3 1/2 lbs

No name 185 TC red T.C. 5 lbs.

4317

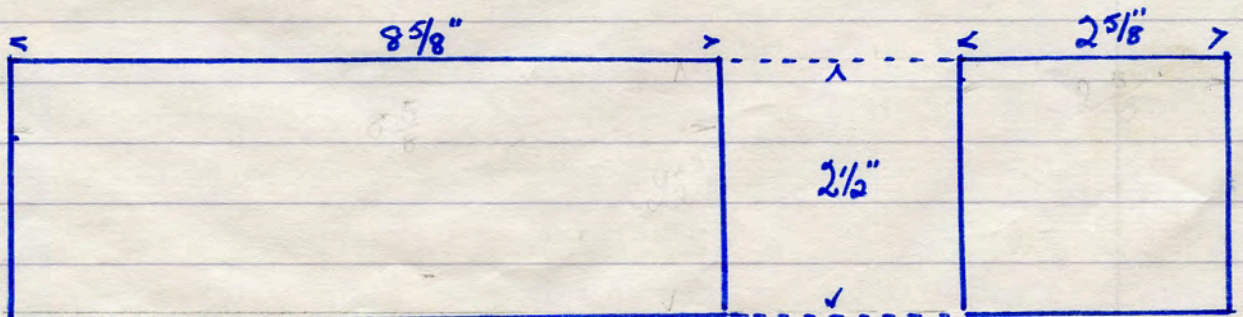

Acfton Mori dem. site 5. 2. '89

4318

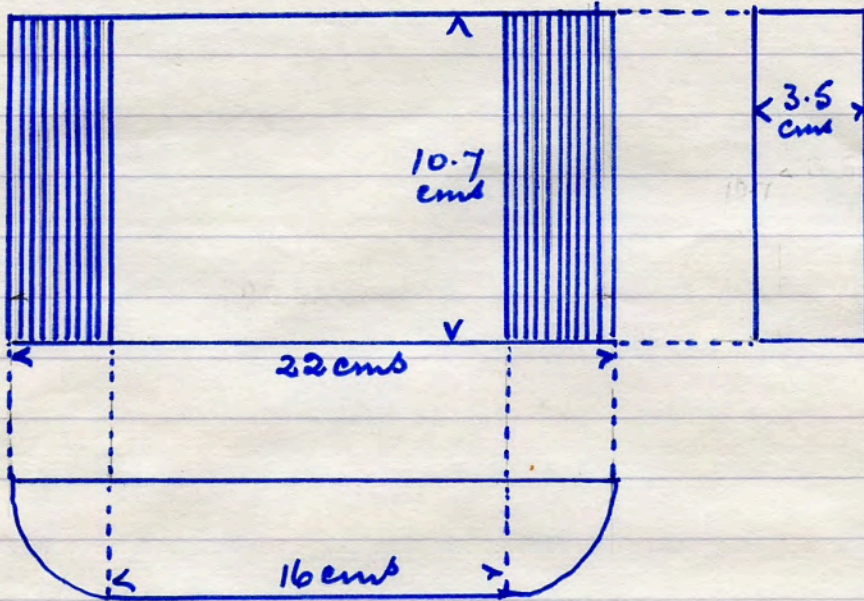

No name
 717 PP
 red T.C
 5 1/2 lbs

4319

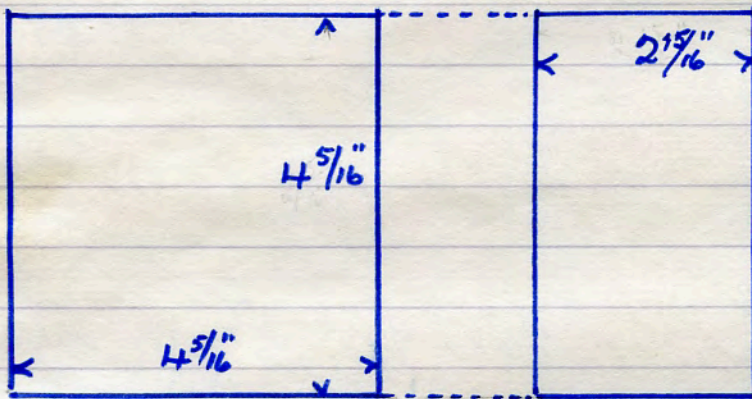

No name
 B12
 red T.C
 5 lbs

4320

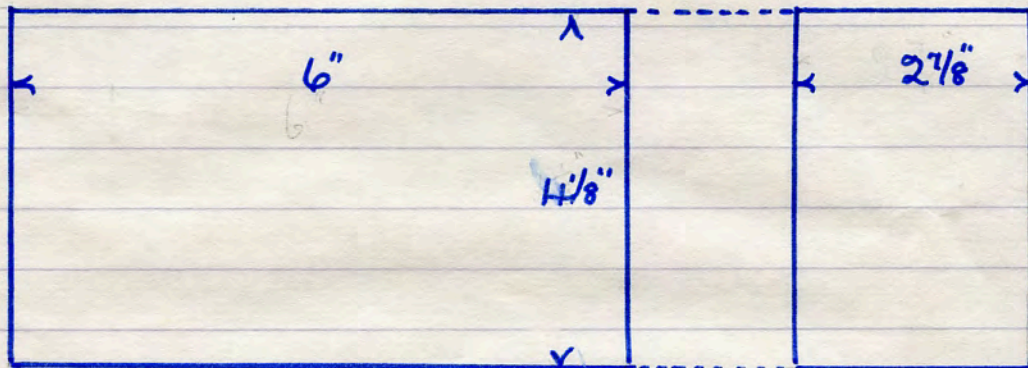

No name
 CT
 red T.C.
 7 lbs

4321

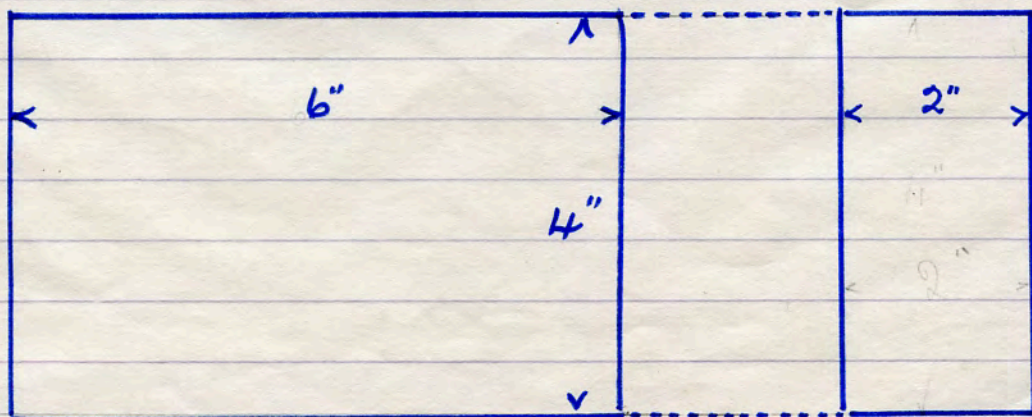

No name
 CBB
 red T.C
 5 lbs

4322

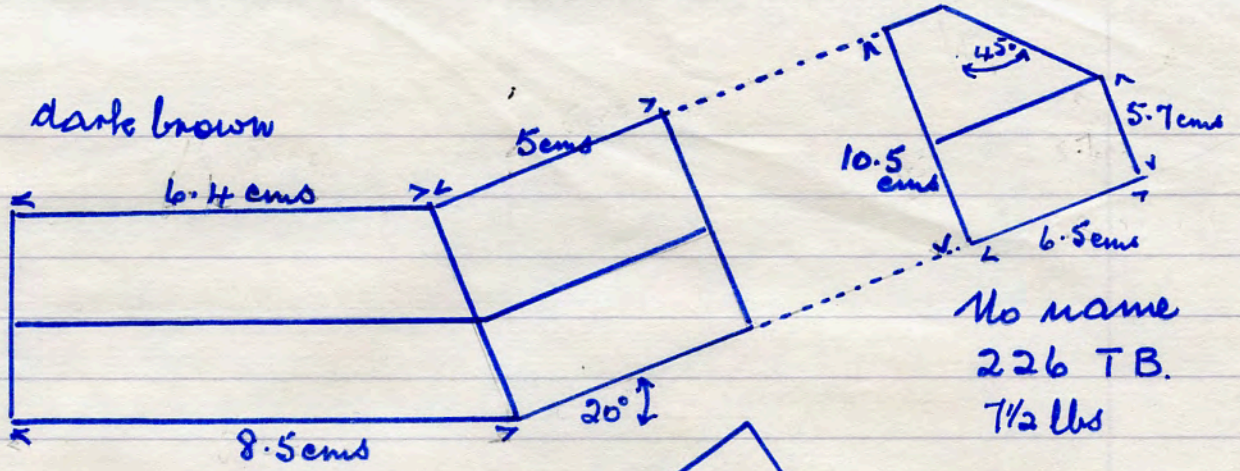

No name
 226 TB.
 7 1/2 lbs

4323

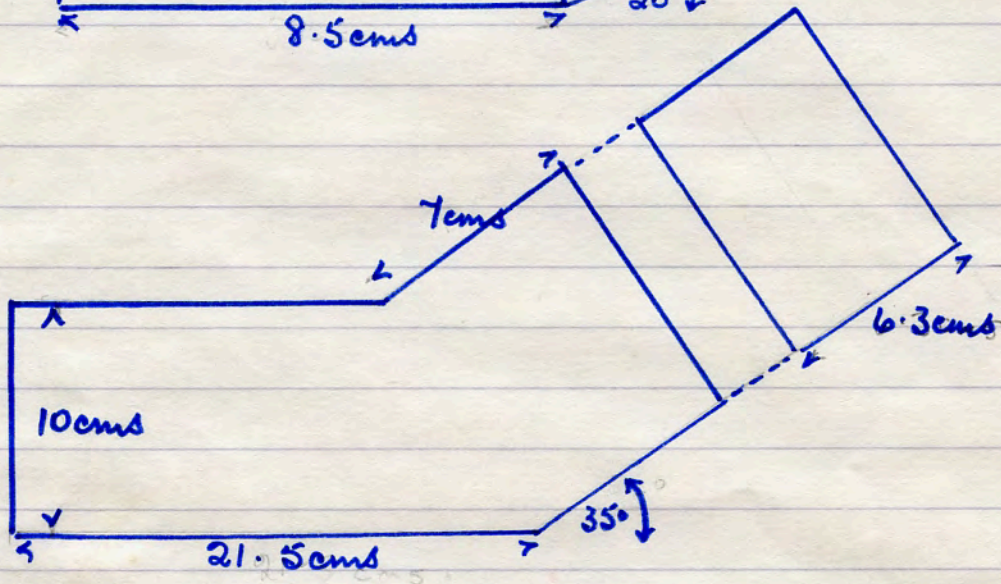

No name
 948 VA
 red T.C
 9 1/2 lbs

4324

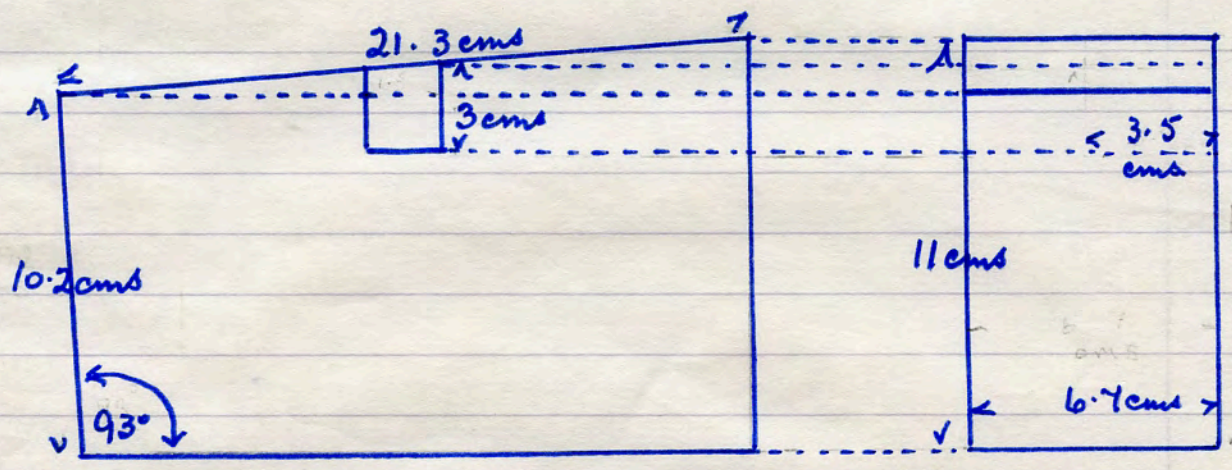

No name. 170 TR red T.C. 8 lbs.

Acc/Kon Mori dem. site 14. 2. '89

No name 93 Q 32
red T.C 10 lbs.

4325

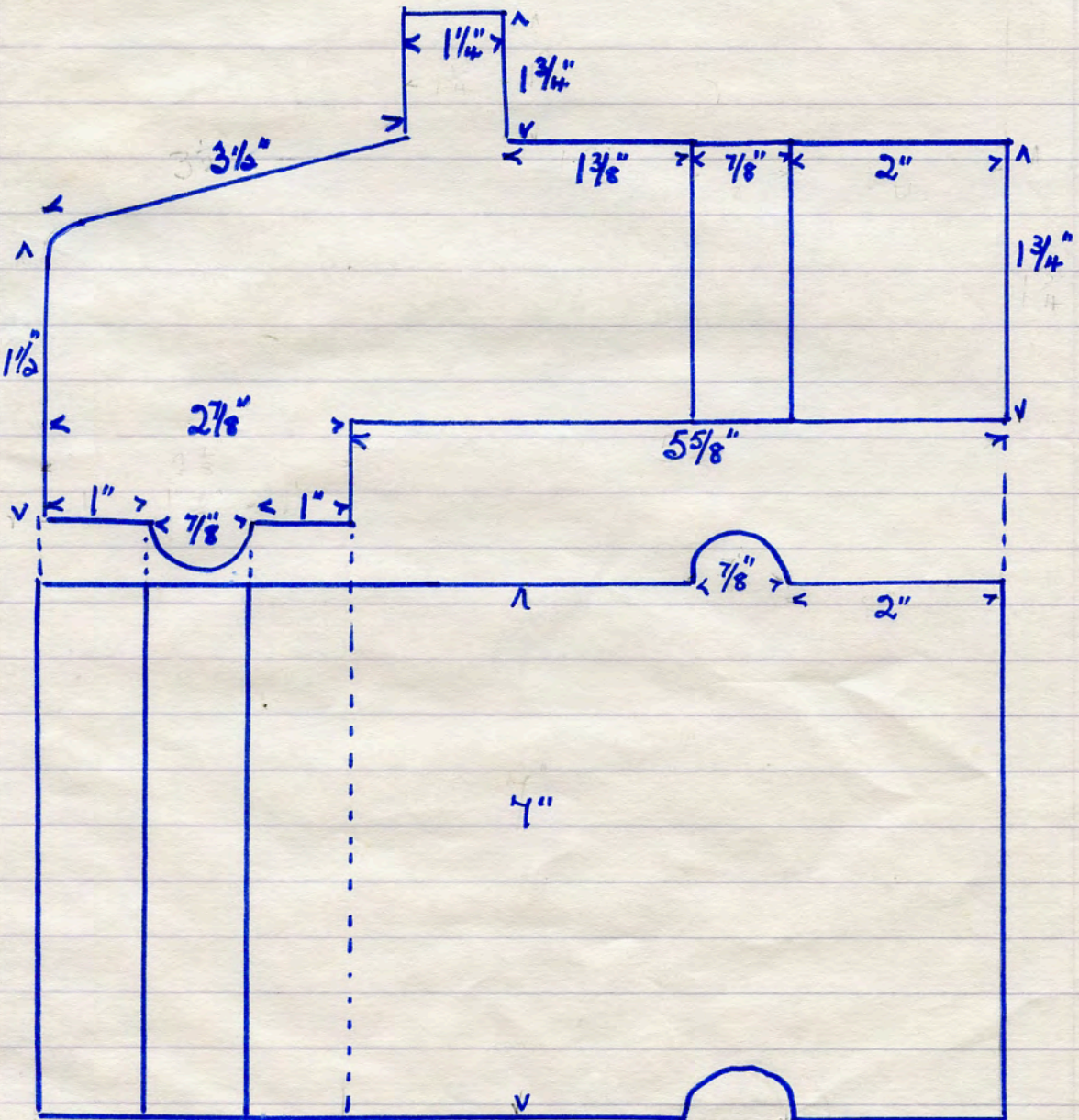
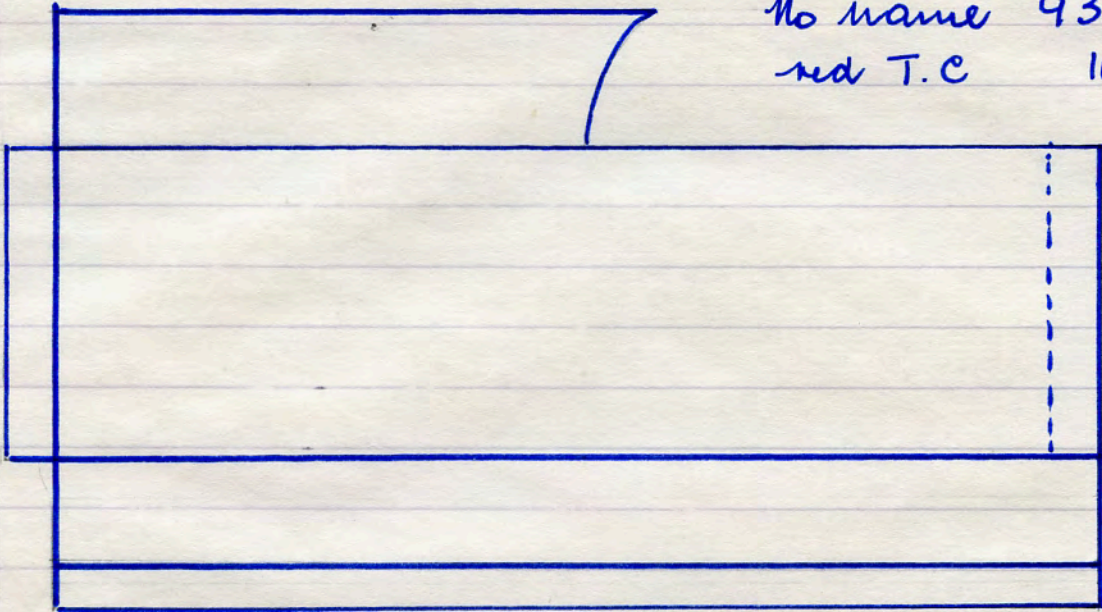

Asst. Hon. Mem. side 14. 2. '89

No name. 2 - 6 red T.C. 14 lbs. moulder's mark JC.

4326

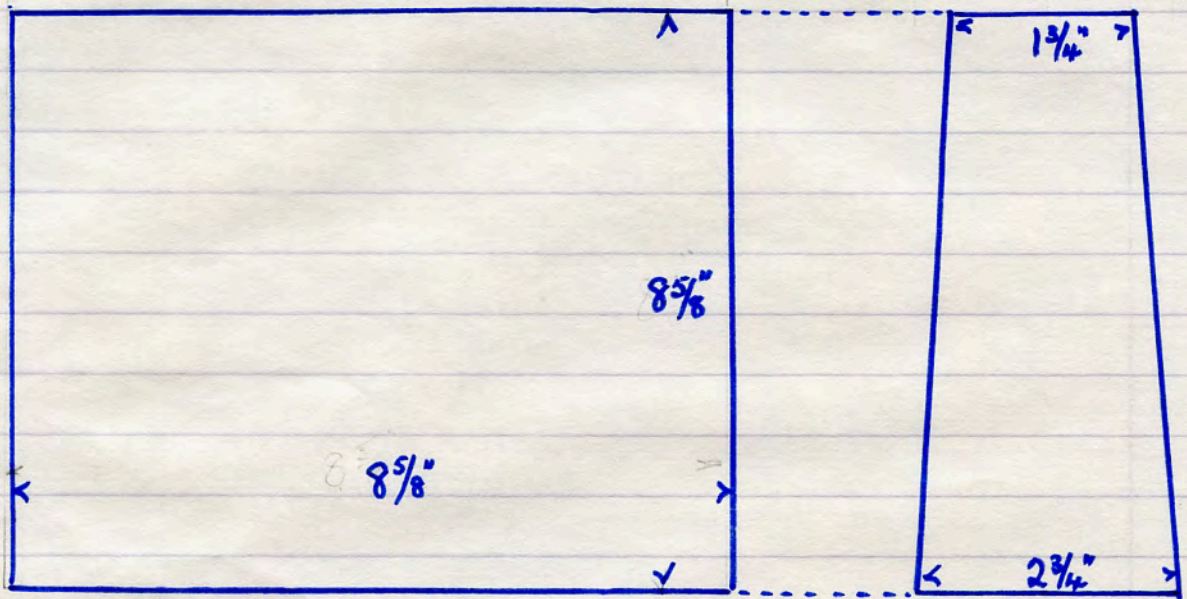

No name. no number red T.C. 2 lbs

4327

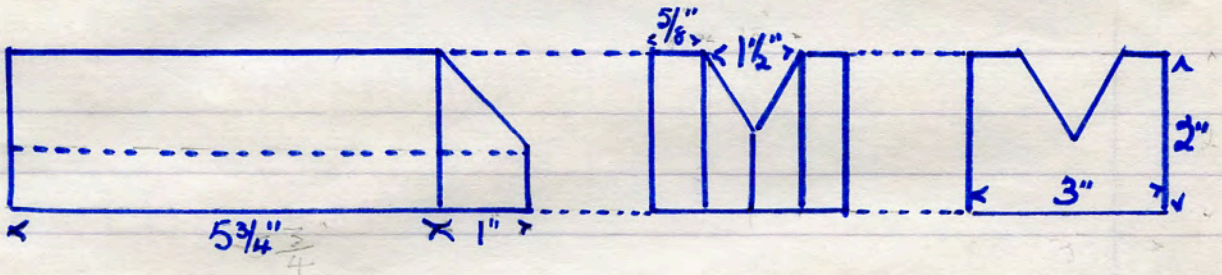

4328

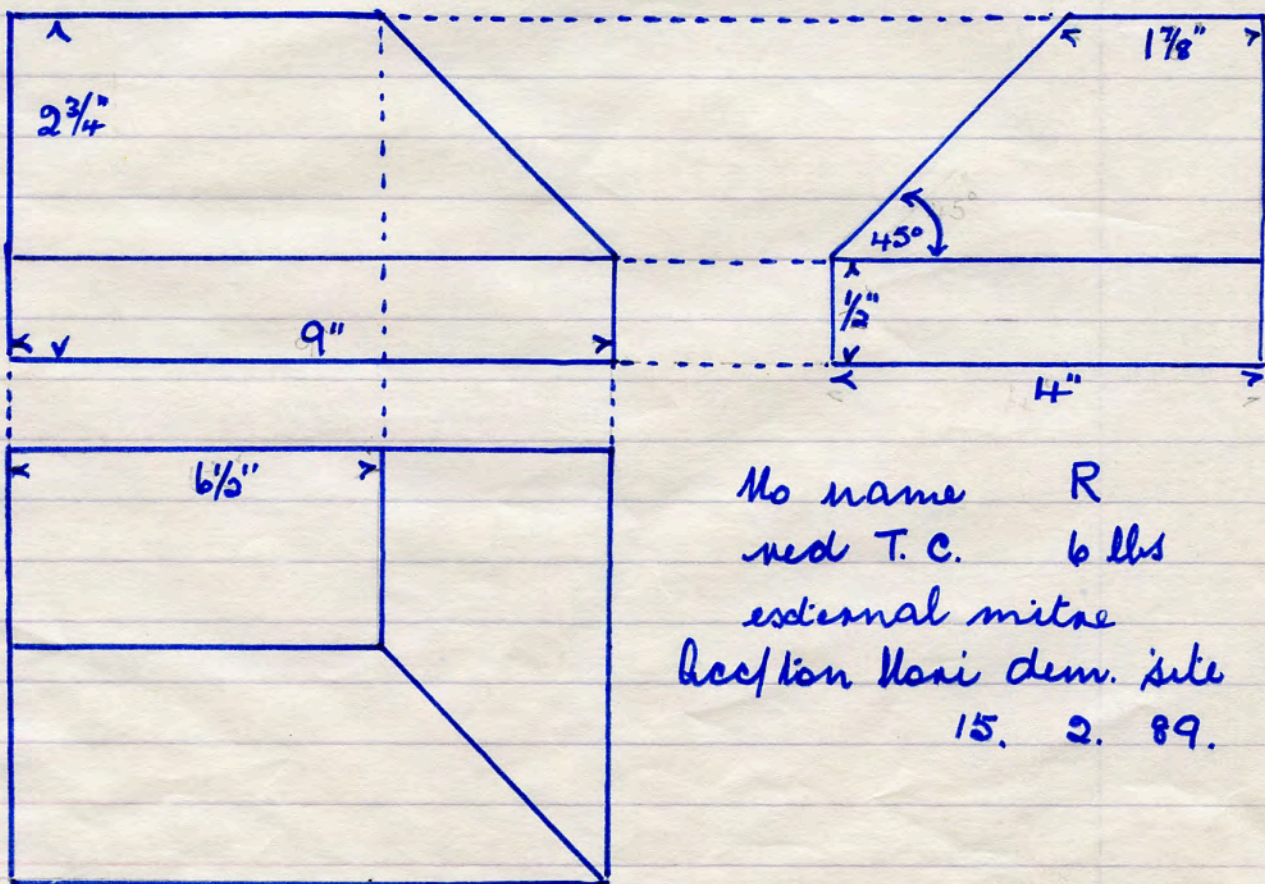

No name R
red T.C. 6 lbs
external mitre
Acception Honi dem. site
15. 2. 89.

4329

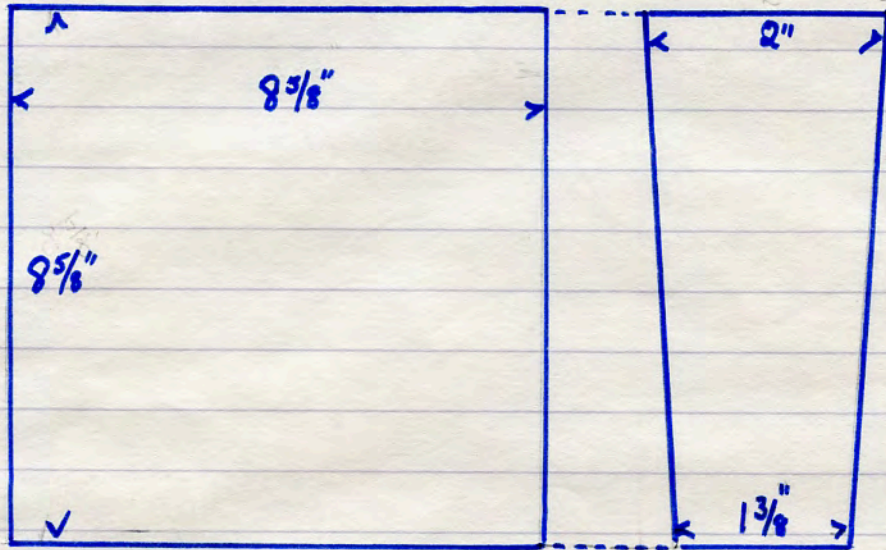

No name
 4 X
 red T.C
 11 lbs
 moulder's marks J1

4330

No name PL red T.C. 7 lbs

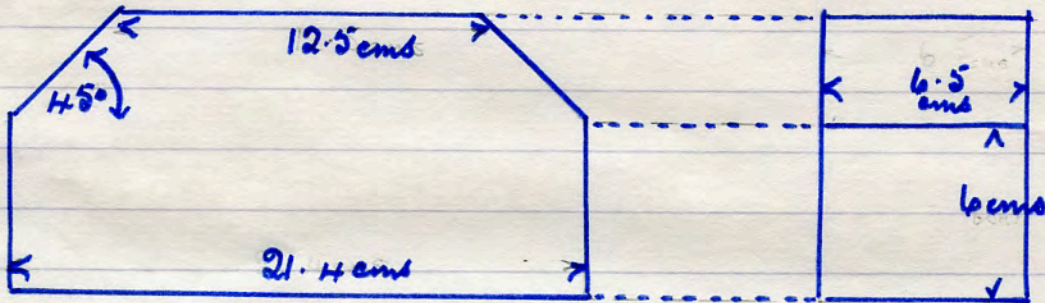

4331

No name 2A 5H red T.C. 7 lbs

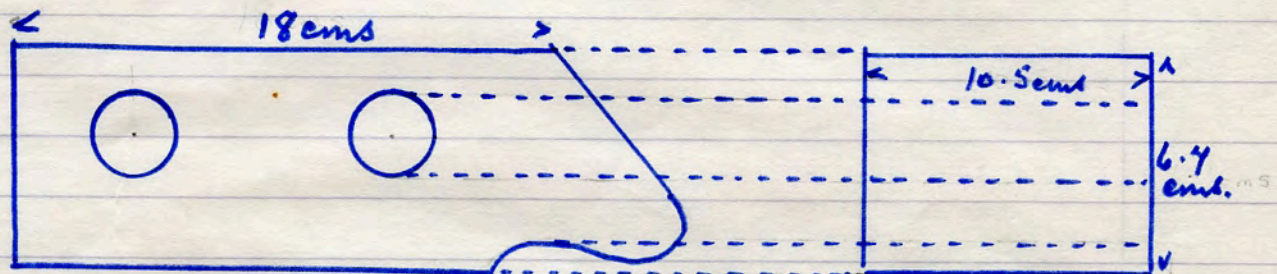

4332

No name 82 V red T.C. 6 lbs

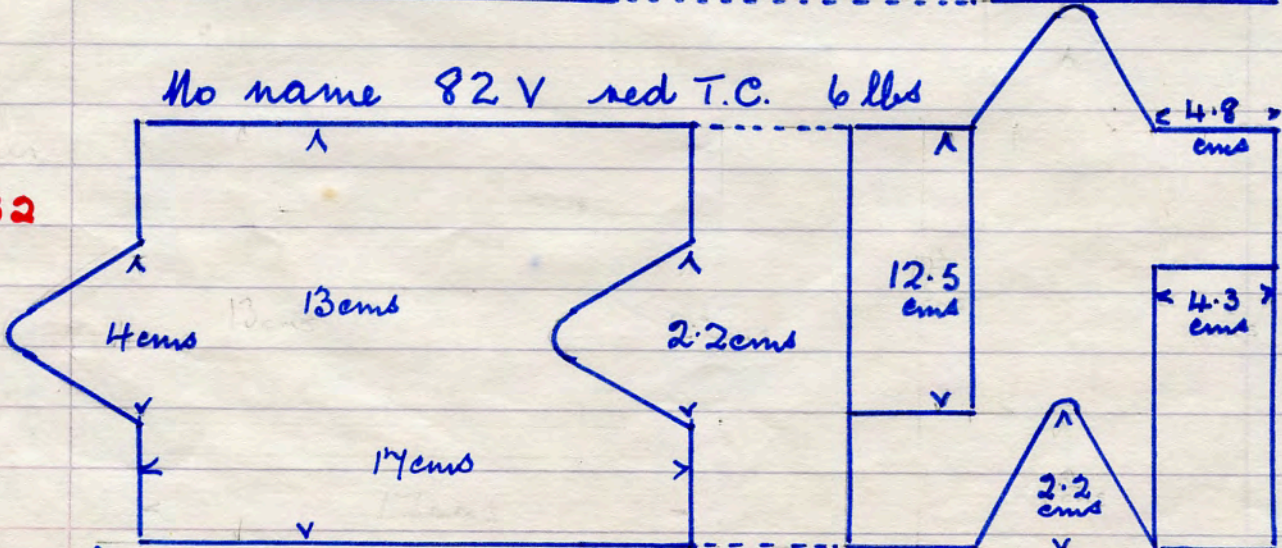

Acpton Mossi dem. site 16. 2. 89.

4333

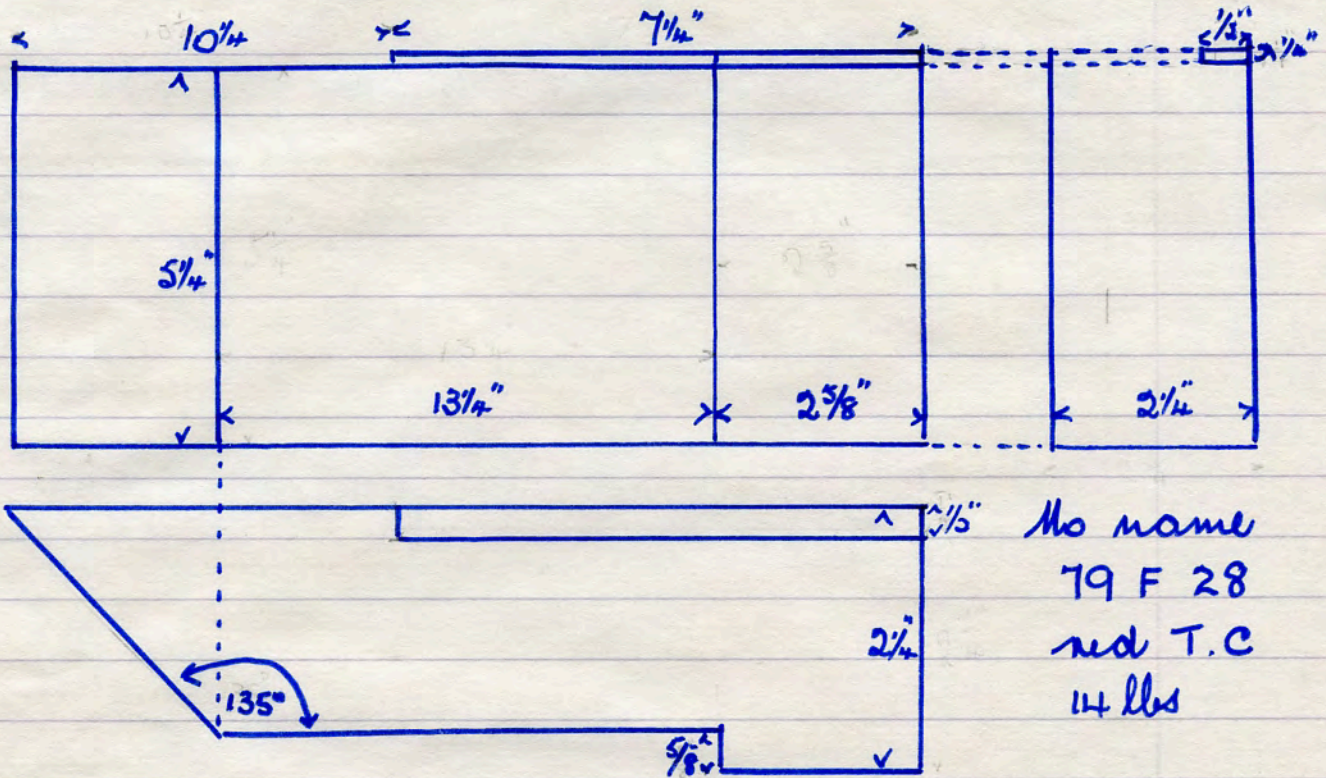

No name
 79 F 28
 red T.C
 14 lbs

4334

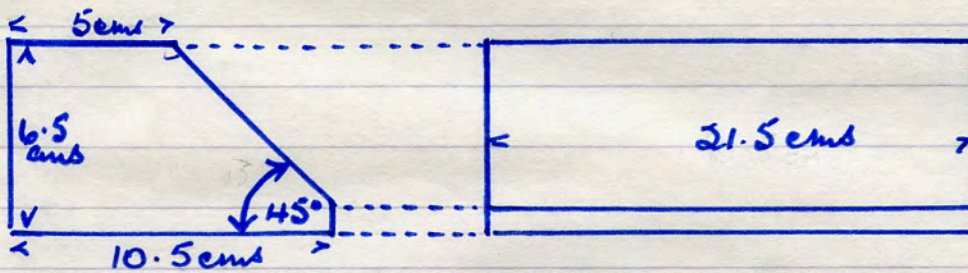

No name
 25-31A
 red T.C
 5 3/4 lbs

4335

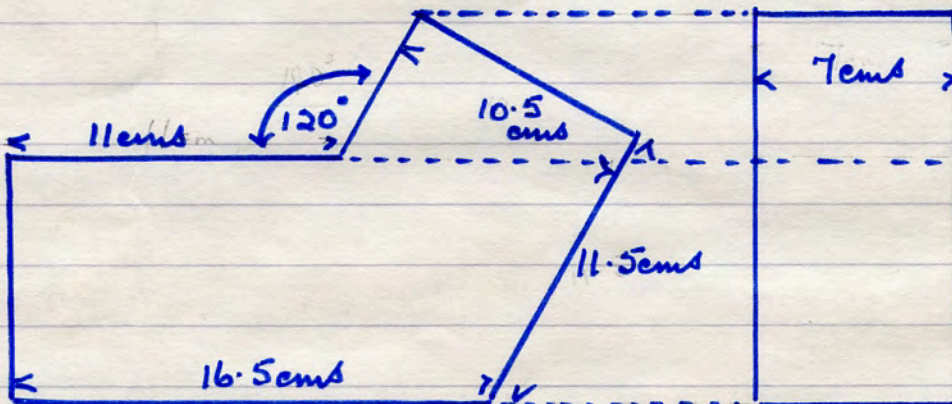

No name
 All
 red T.C
 9 lbs.

internal angle sand faced

Asp/ton Hori dem. site 5. 2. '89 + 16. 2. '89

4336

No name
87 M 254
red T.C.
6 lbs.

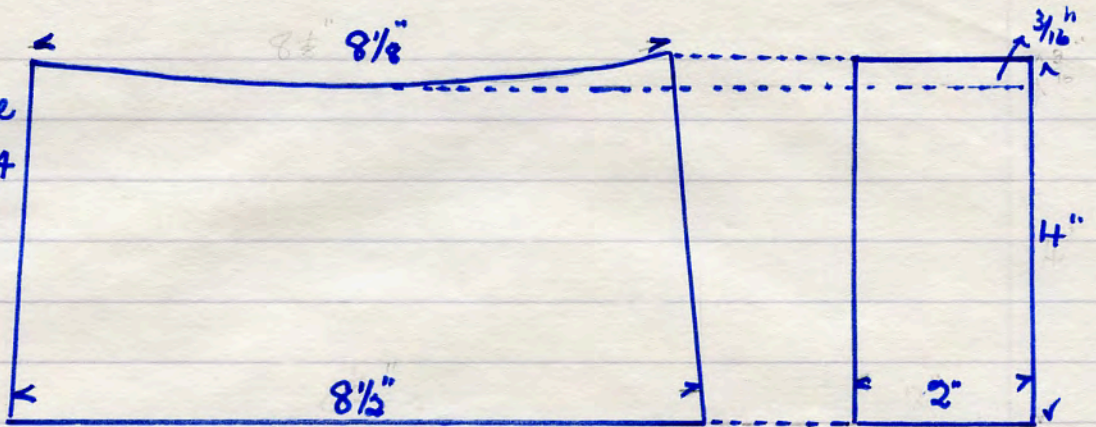

4337

No name 998 VII red TC
9 lbs

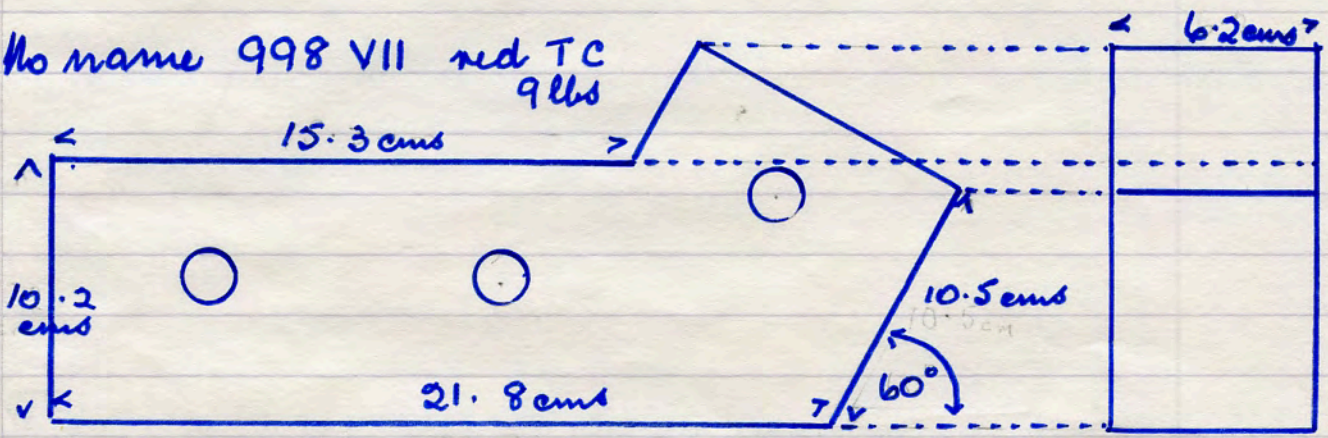

4338

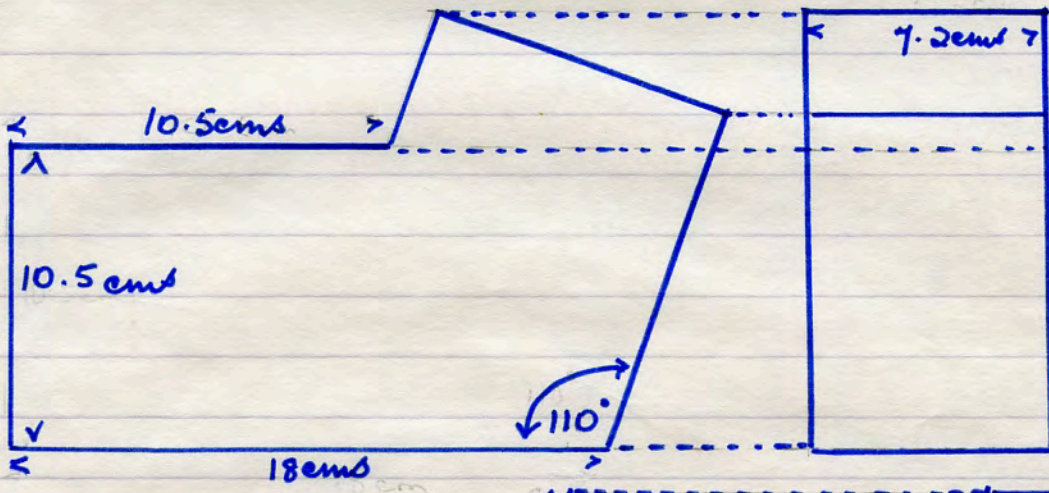

No name
350 TA
red T.C.
9 1/2 lbs

4339

No name 998 V12
red T.C. 8 1/2 lbs.

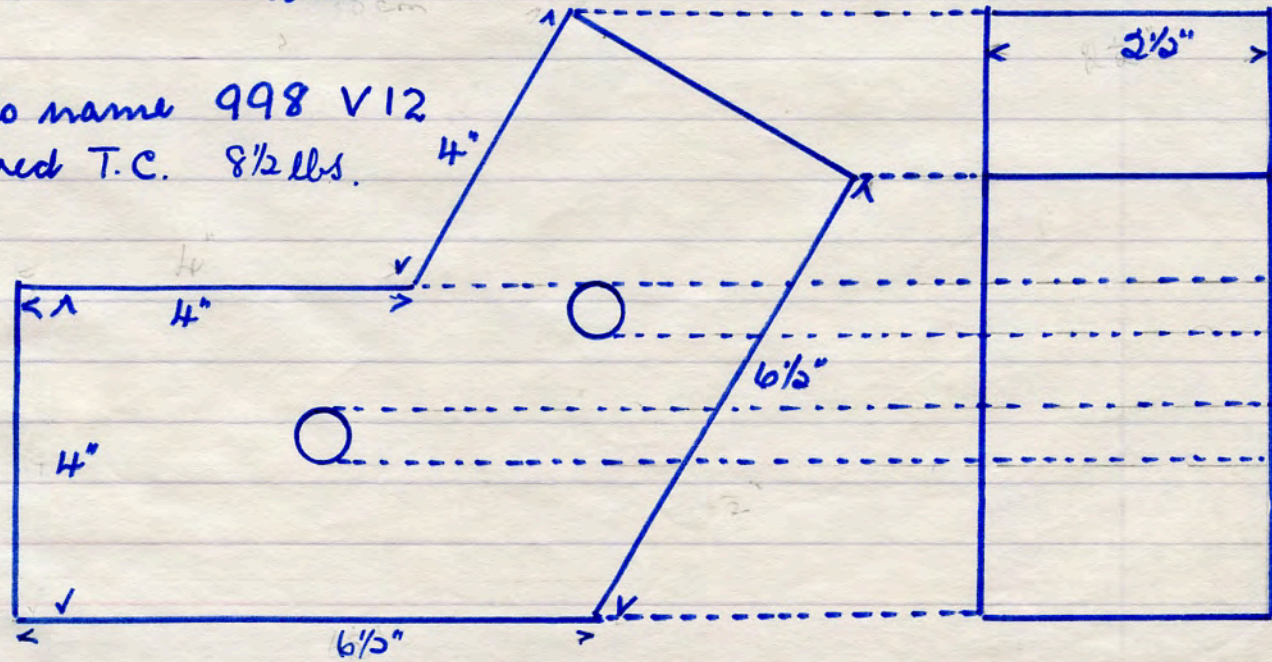

4340

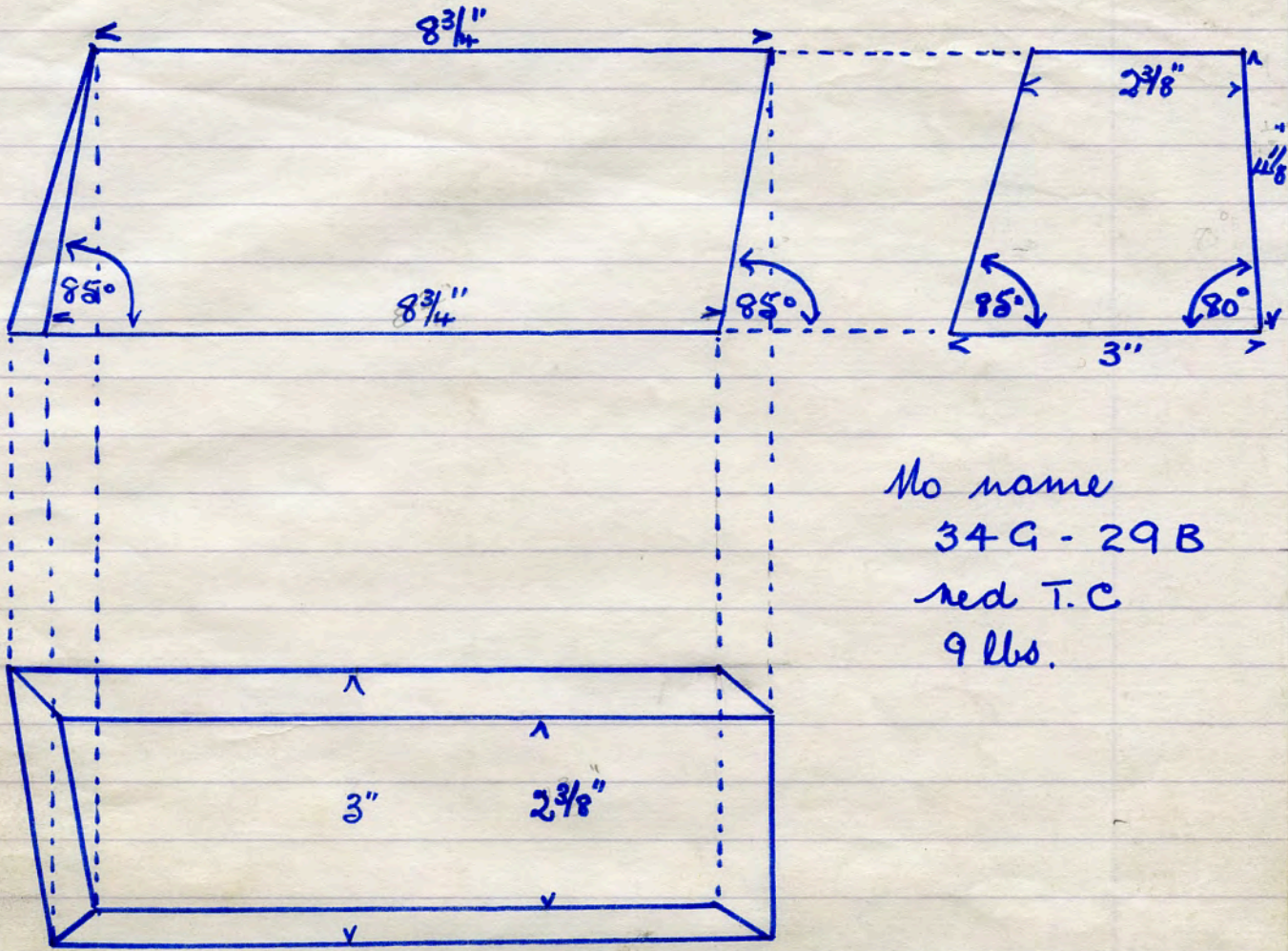

No name
 34 G - 29 B
 red T.C.
 9 lbs.

4341

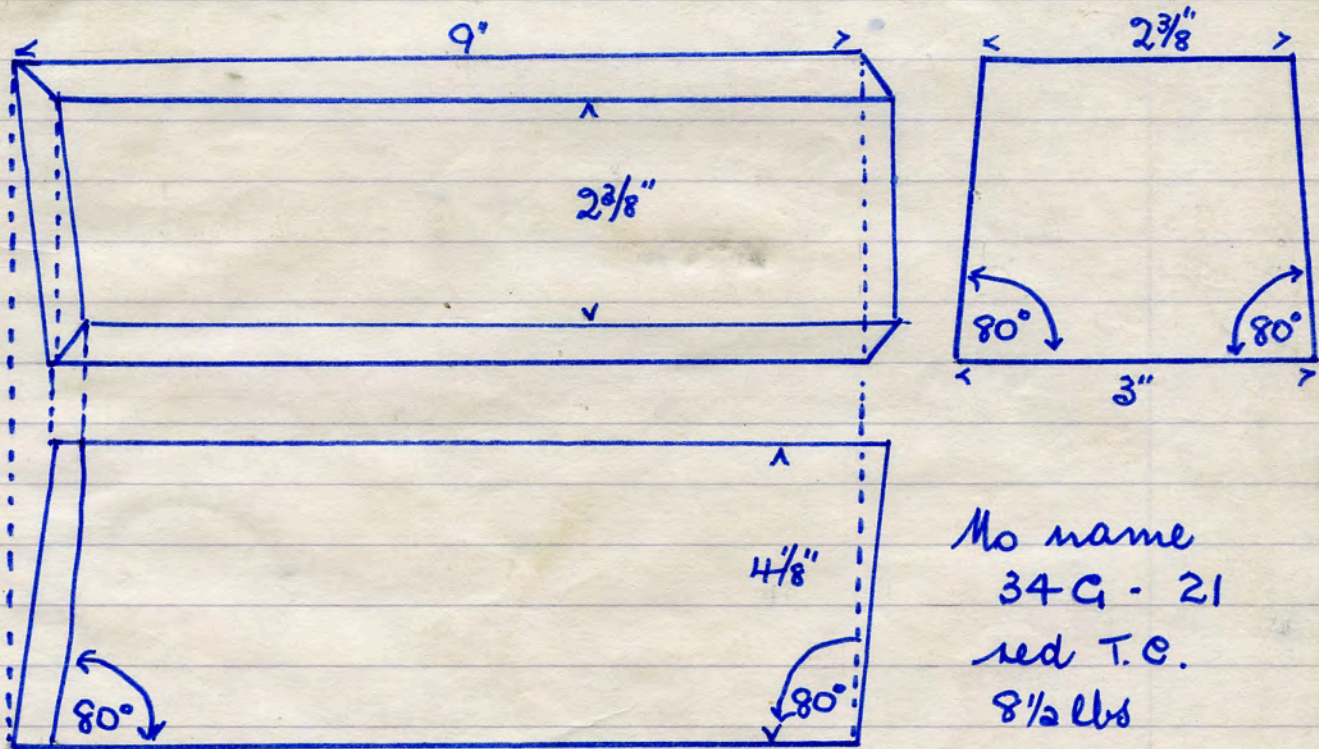

No name
 34 G - 21
 red T.C.
 8 1/2 lbs

Acetone Hosi dem. site 15. 2. '89

4342

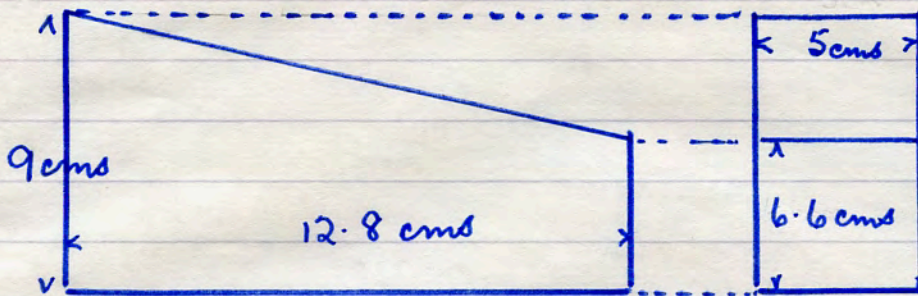

No name
 38 L 2
 red T.C
 4 lbs

4343

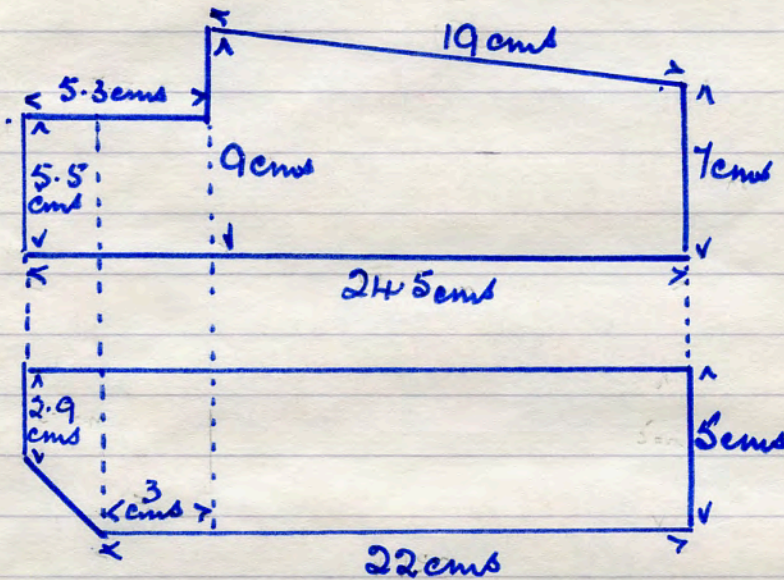

No name
 38 L 3
 red T.C
 5 lbs

4344

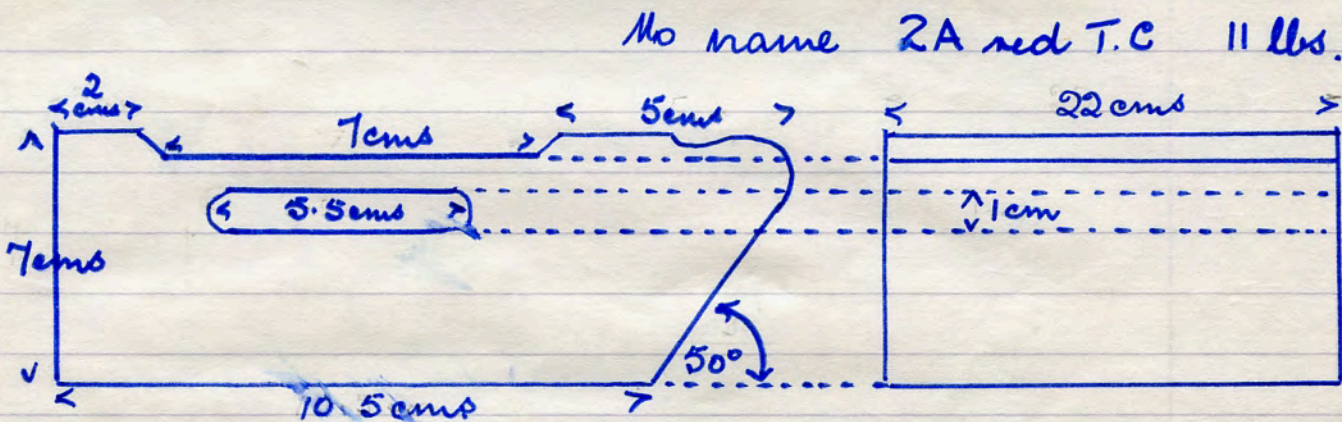

No name 2A red T.C 11 lbs.

Acception Moss dem. site 17. 2. '89

H-345

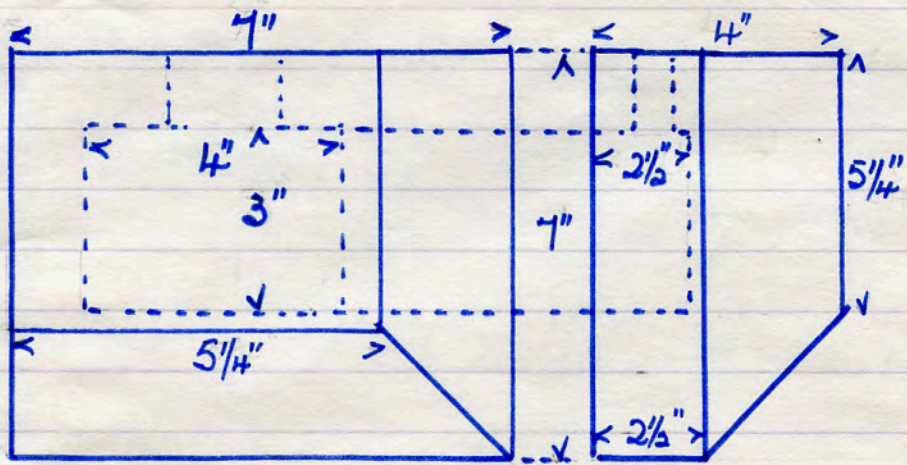

No name
284 T2.
red T.C.
12 lbs

No name 246 - 235 red T.C 18 lbs.

H-346

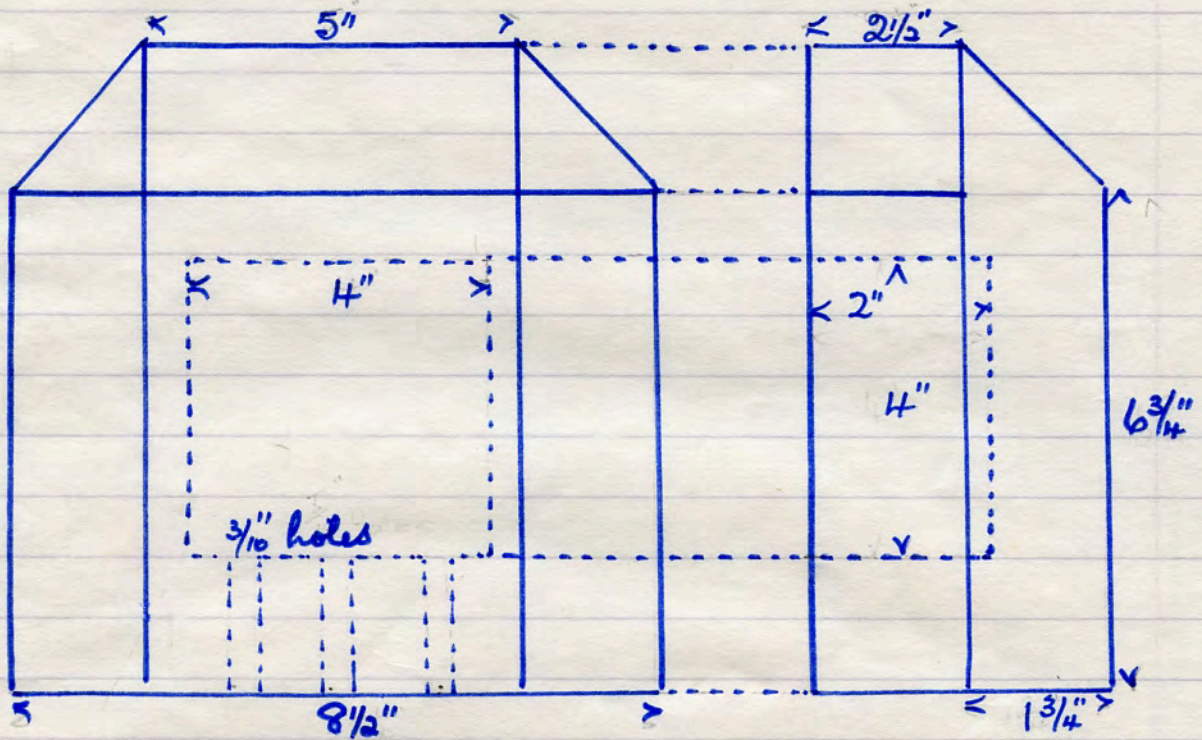

No name 2321 X SA red T.C. 21 lbs.

H-347

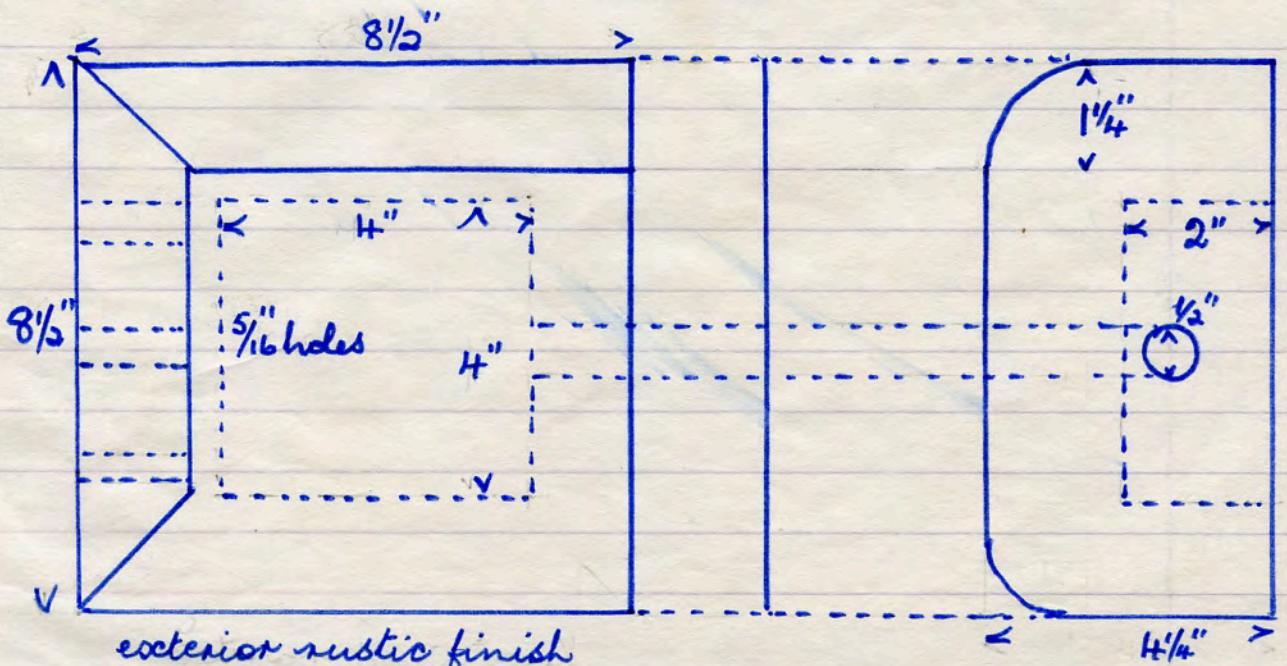

4348

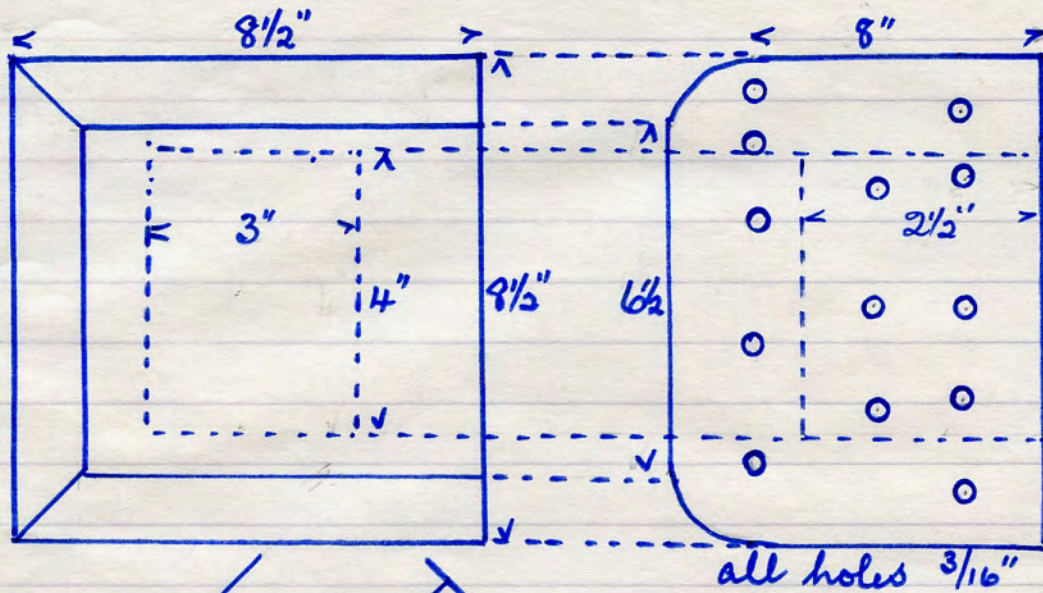

No name
 23153
 red T.C
 21 lbs.

4349

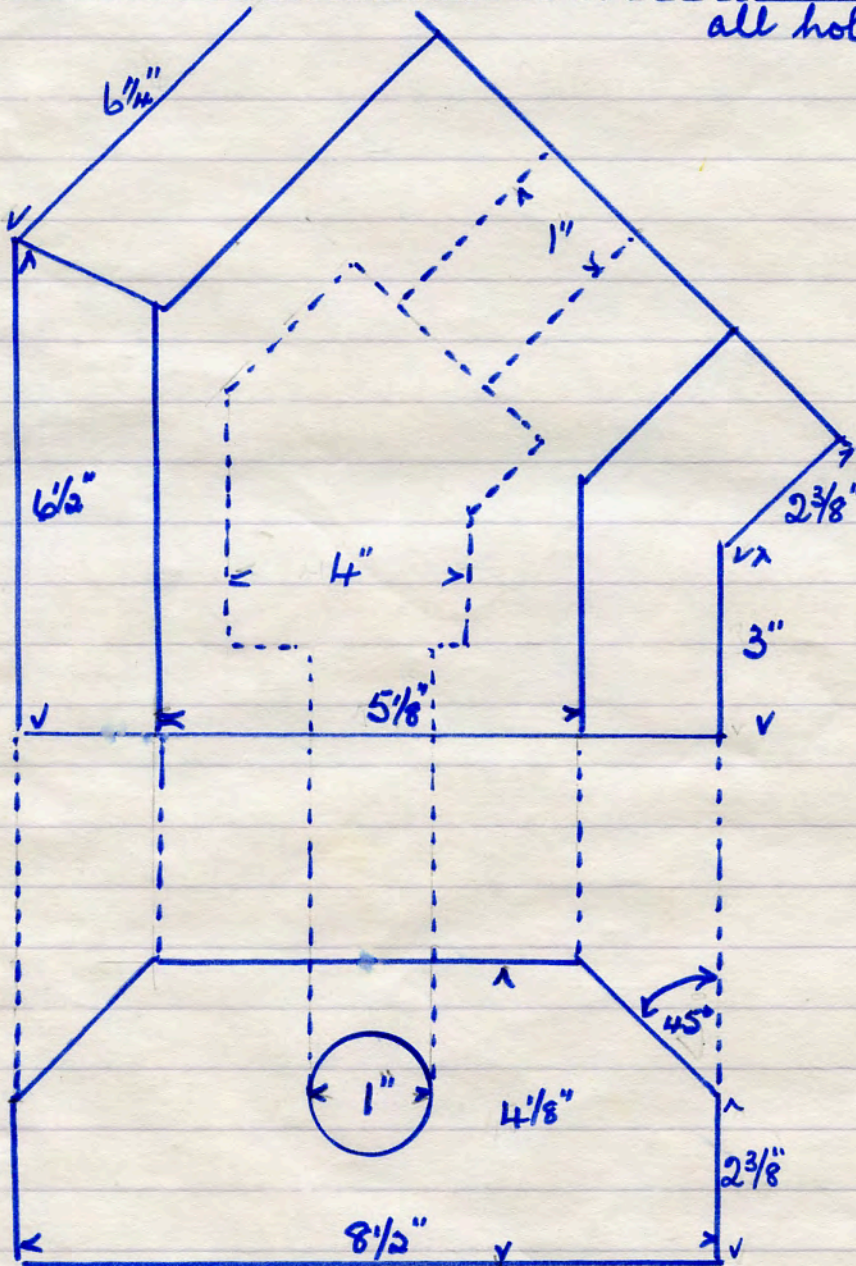

No name
 246 245A
 red T. C.
 20 lbs

Acfton Mari dem. site 18. 2. '89

No name 947 VA red T.C. 42 lbs.

4350

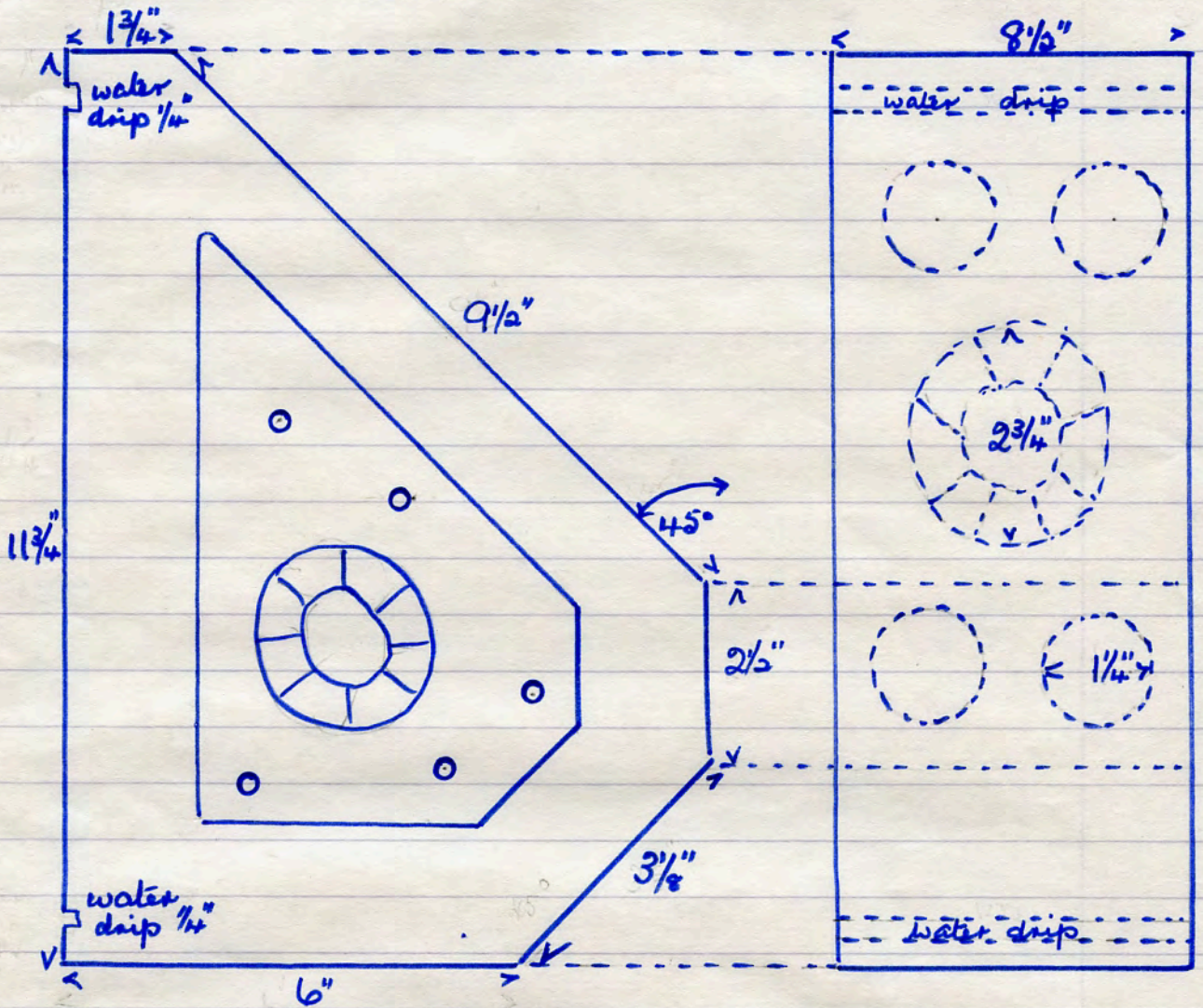

No name 14 P 134 red T.C. 4 lbs

4351

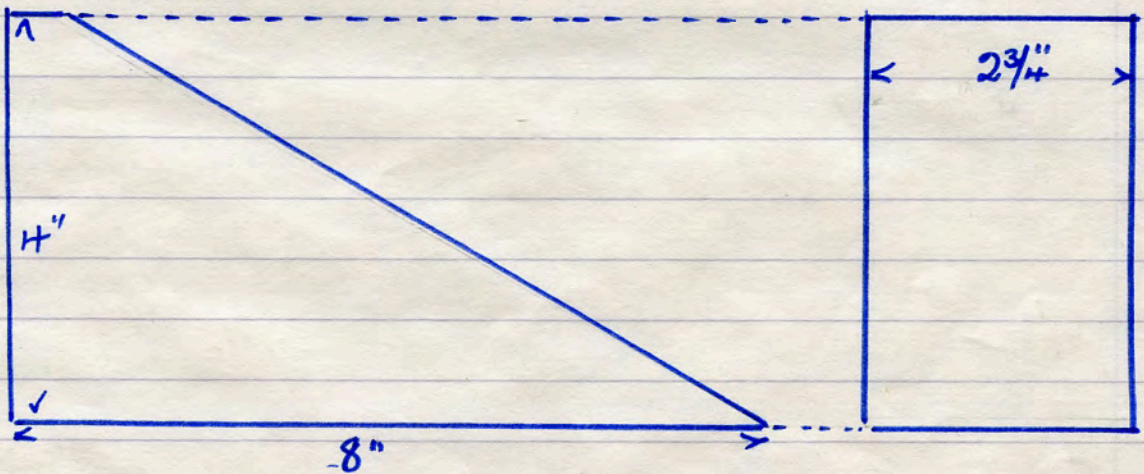

Acclon Mosi dem. site 18. 2. '89

4352

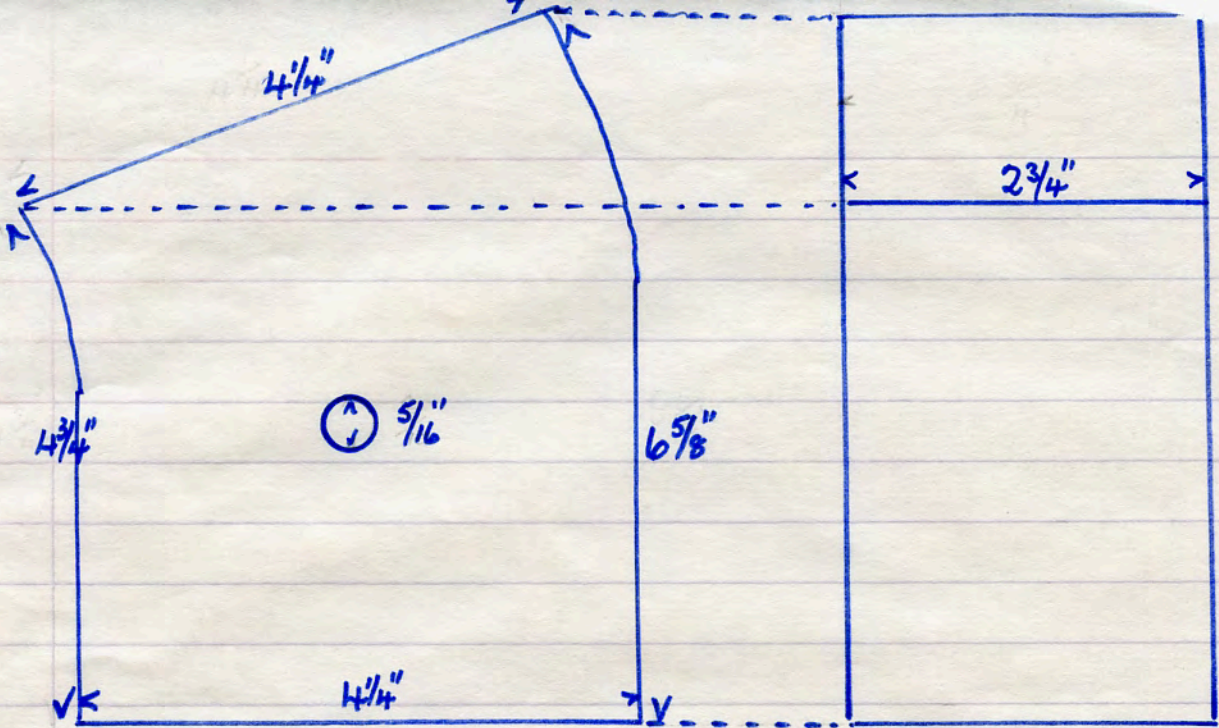

no name 55 M 54 red T. C 5 1/2 lbs.

4353.

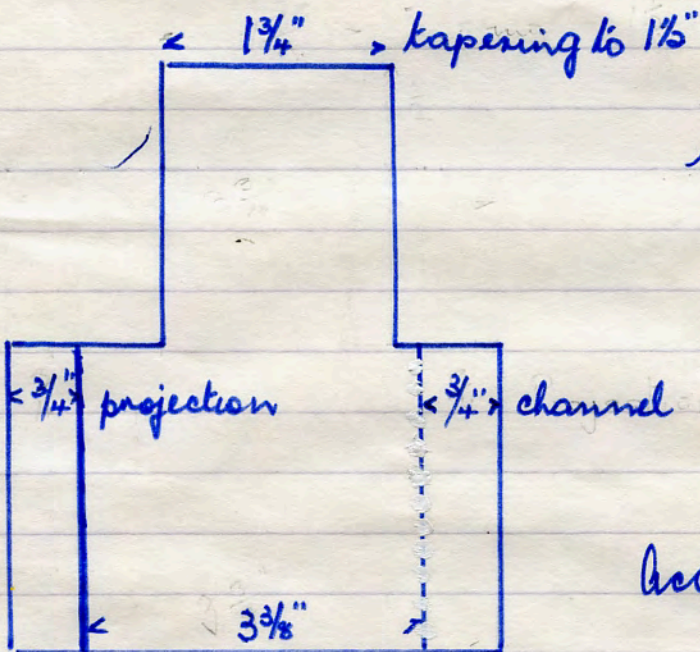

no name 61 P 16
red T. C. 19 lbs.

Section More dem. site
19. 2. '89

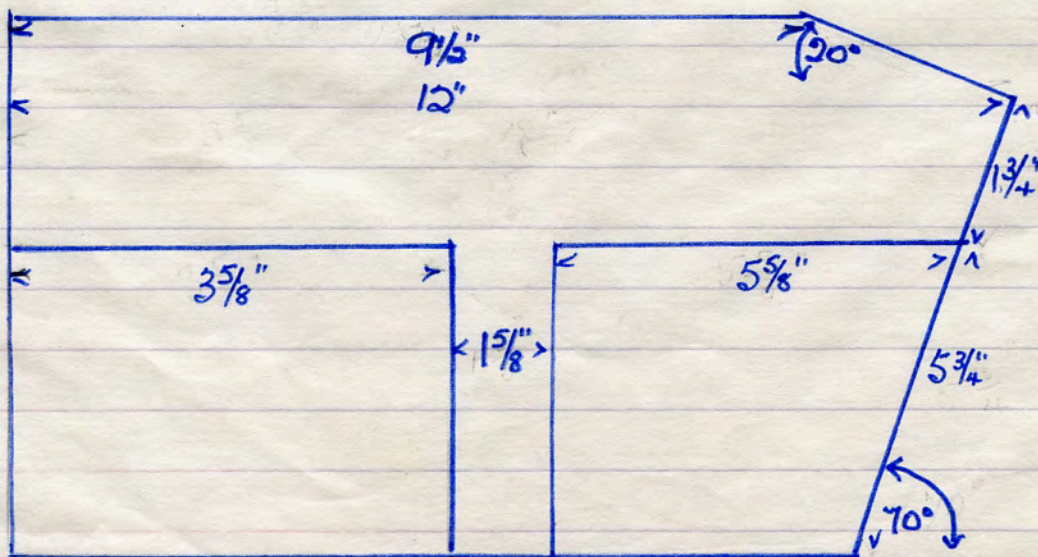

4355

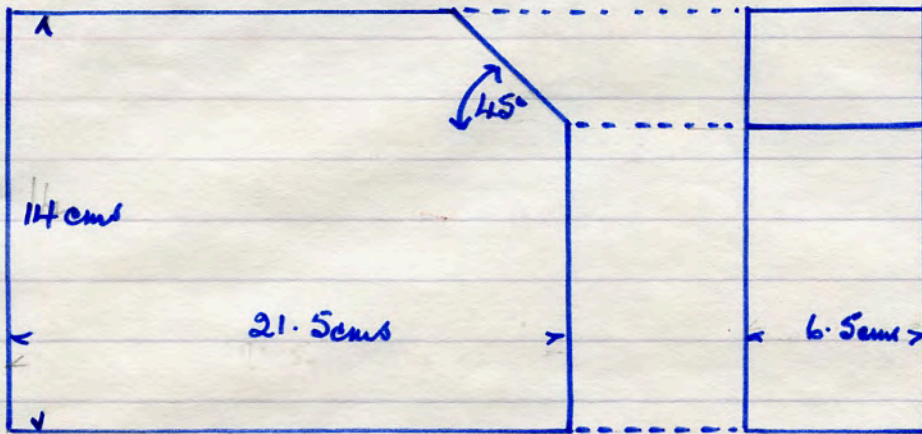

No name
 268 TA
 red T.C.
 10 lbs
 Acc'ton Mori
 dem. site
 23. 2. '89

4356

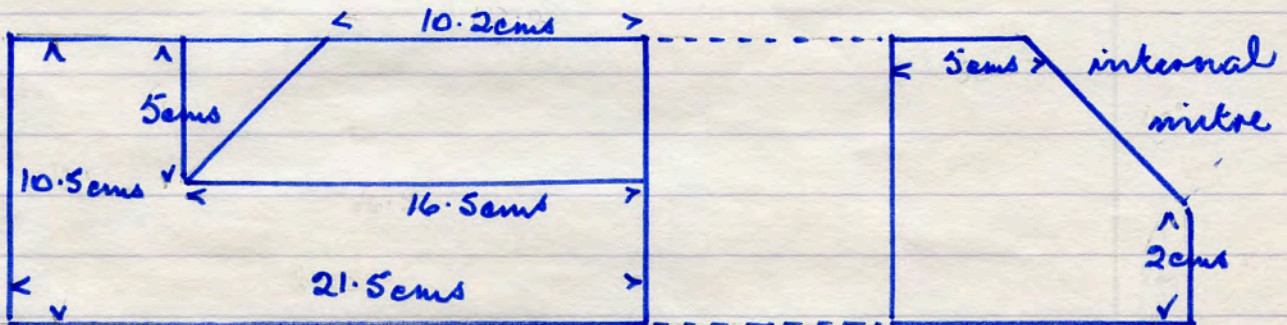

No name R red T.C. 7 lbs Acc. Mori dem. site
 22. 2. '89

No name no number red T.C. 9 lbs

4357

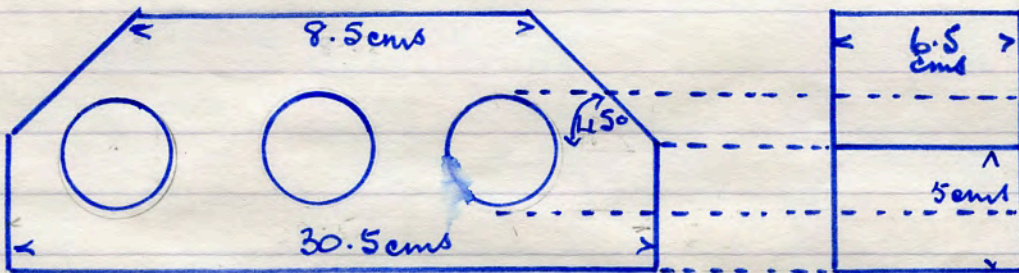

Acc'ton
 Mori dem.
 site 23. 2. 89

4358

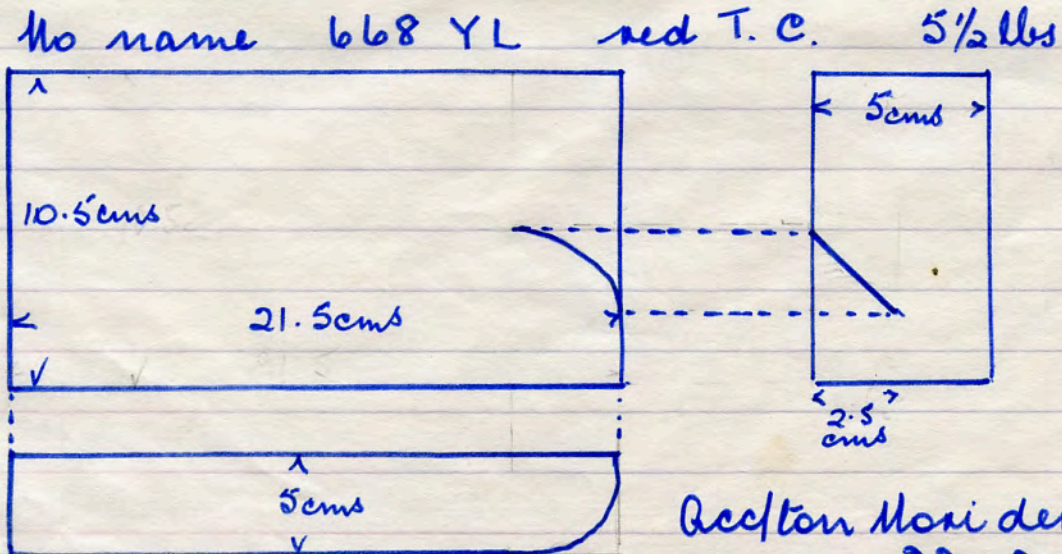

Acc'ton Mori dem. site
 22. 2. '89

No name 668 YL red T.C. 5 1/2 lbs

4359

No name 2814 A red T.C. 3 1/2 lbs

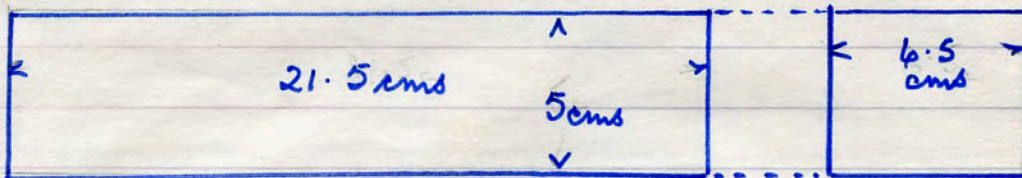

Acc. Mori dem. site 21. 2. '89

4360

No name 58 NE red T.C. 3 1/2 lbs

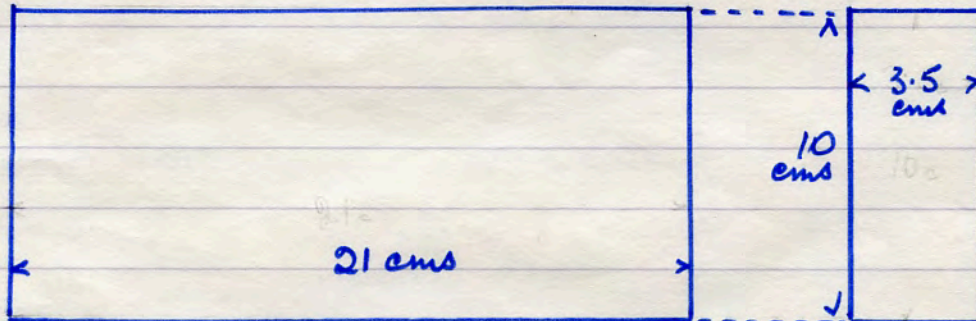

Acc. Mori dem. site 22. 2. '89

4361

No name EX 94 A red T.C. 4 lbs.

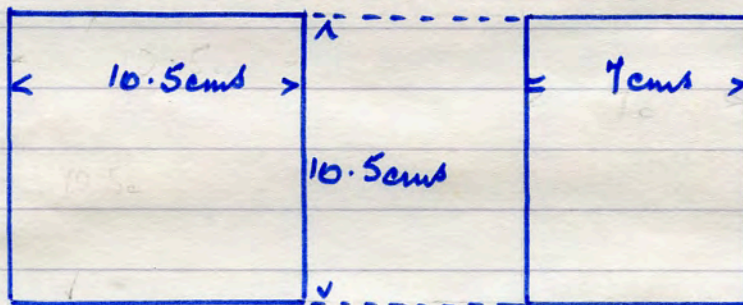

Acc. Mori dem site 22. 2. 89.

4362

No name T 28 red T.C. 9 lbs

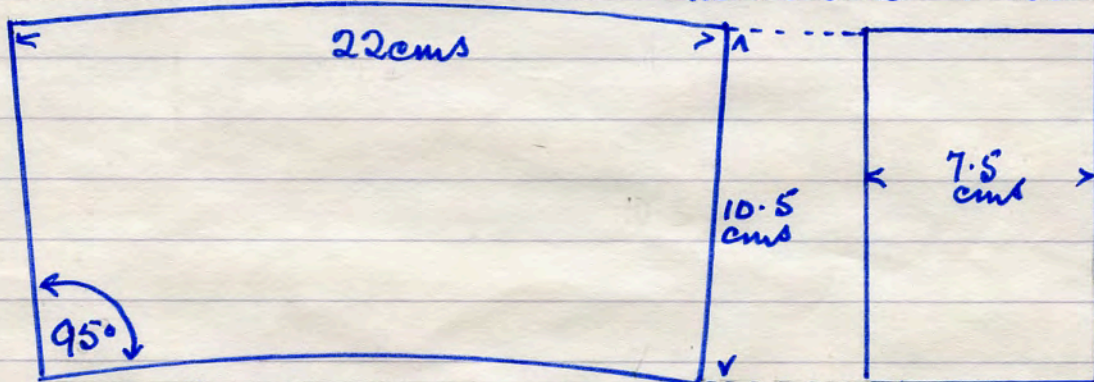

Acc/Kon Mori dem. site 22. 2. '89.

4363

No name 176 VR red T.C. 7 lbs

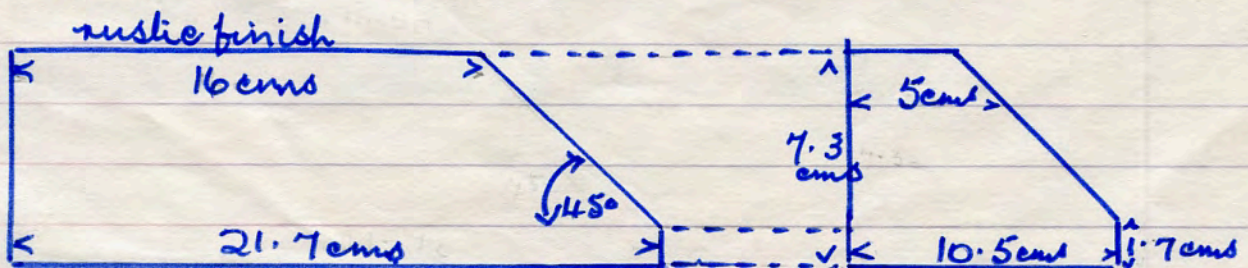

Acc/Kon Mori dem. site 21. 2. 89

No name 134 TR dark brown 9 lbs
 Acc/ton Mori dem site

22. 2. '89

4364

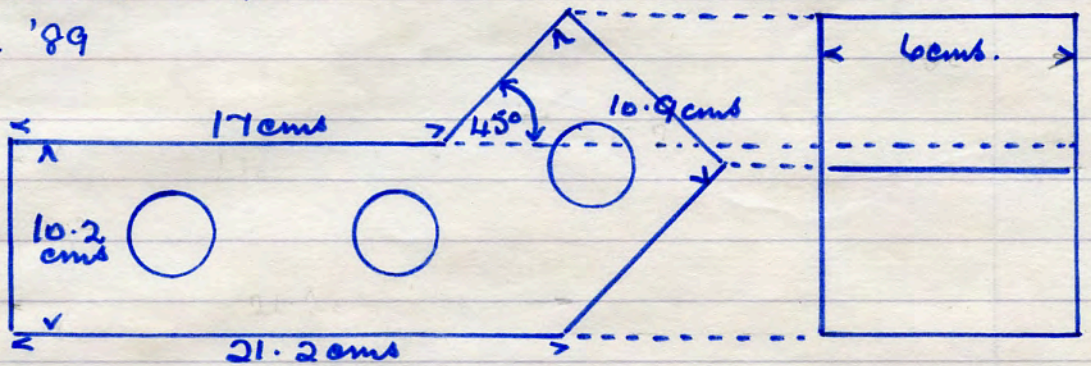

Acc. Mori dem. site 22. 2. '89

No name 23102 CL dark brown 7 lbs

4365

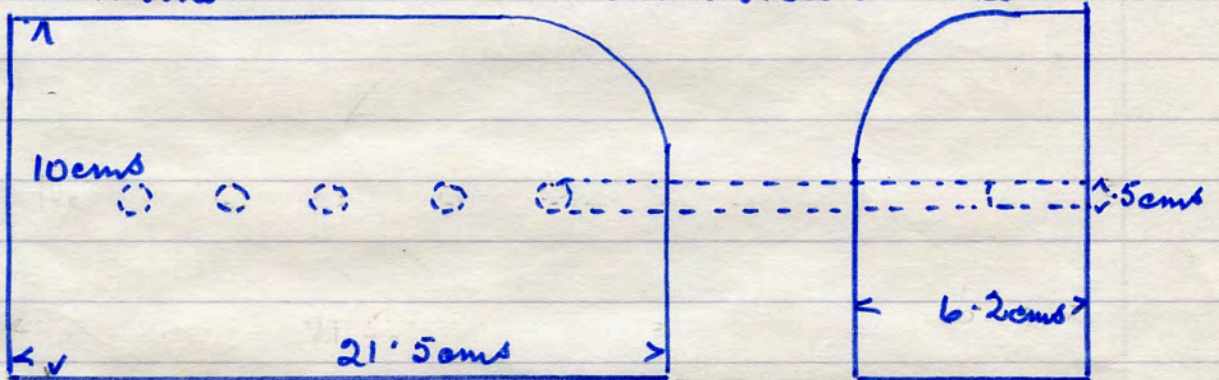

No name 781 UCR dark brown 14 lbs

4366

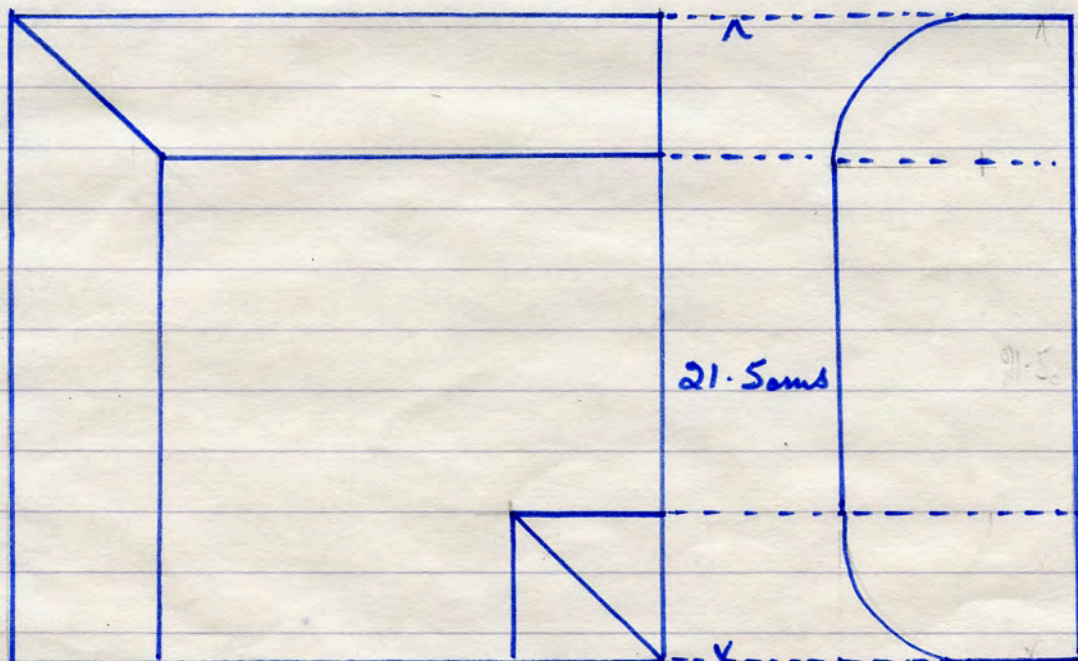

Acc/ton Mori dem. site

21. 2. 89.

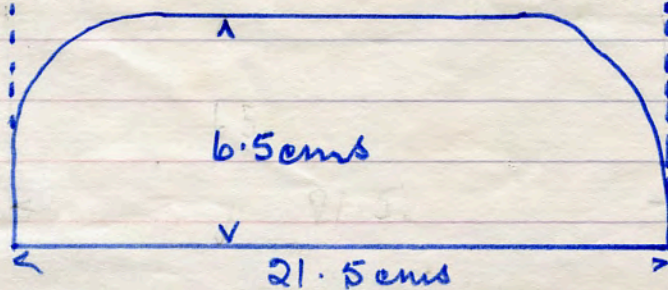

No name 2422 DR
dark brown.

7 lbs

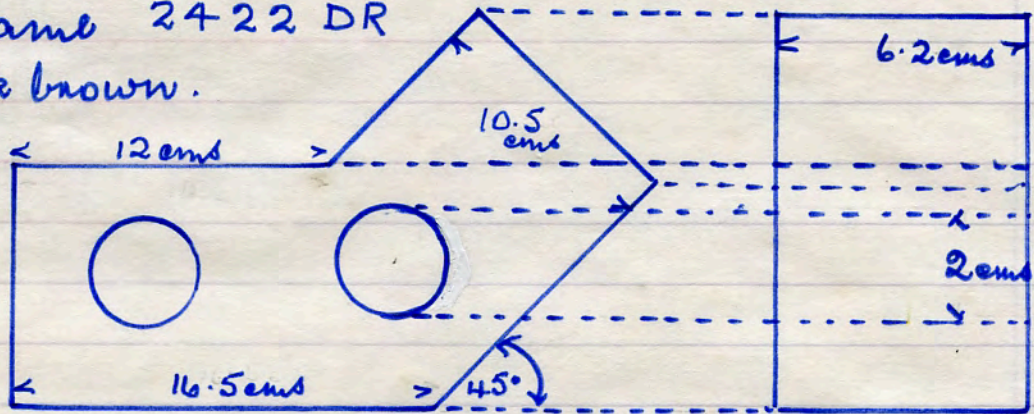

4367

No name, 2412 ER dark brown, chisel face 6 lbs.

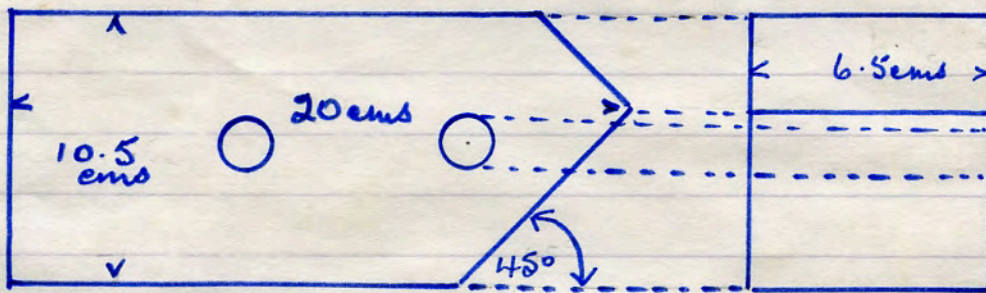

4368

Acfton Mori dem. site 22. 2. '89

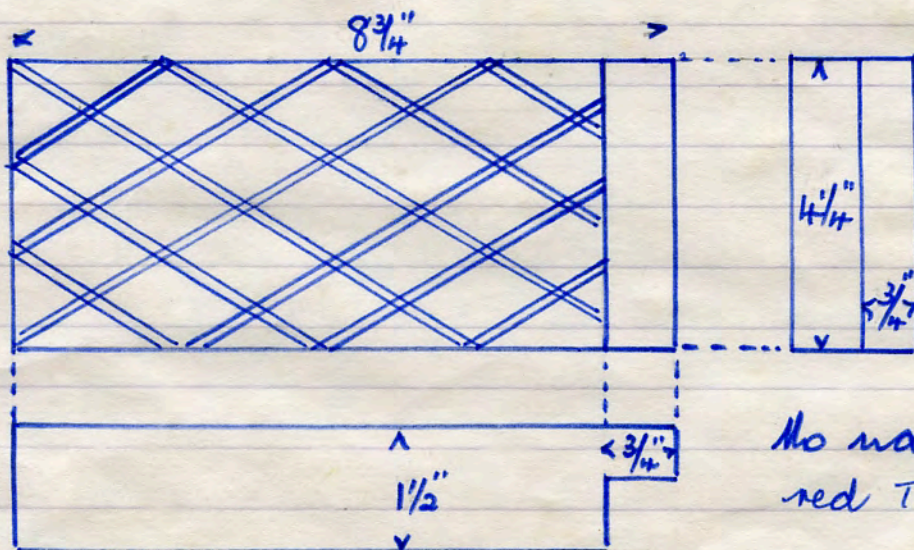

4369

No name GLR
red T.C. 4 3/4 lbs.

Acfton Mori dem. site 21. 2. '89